



LYRIQ
OWNER'S MANUAL

2024



Contents

Introduction	1
Keys, Doors, and Windows	6
Seats and Restraints	34
Storage	74
Instruments and Controls	79
Lighting	113
Infotainment System	122
Climate Controls	140
Driving and Operating	148
Vehicle Care	241
Service and Maintenance	288
Technical Data	294
Customer Information	296
eCall	305
Index	307

Litho in U.S.A.
Part No. DLYAEBBE2408EN

Introduction



The names, logos, emblems, slogans, vehicle model names, and vehicle body designs appearing in this manual including, but not limited to, GM, the GM logo, the CADILLAC Emblem, and CADILLAC LYRIQ are trademarks and/or service marks of General Motors LLC, its subsidiaries, affiliates, or licensors.

This manual describes features that may or may not be on the vehicle because of optional equipment that was not purchased on the vehicle, model variants, country specifications, features/applications that may not be available in your region, or changes subsequent to the printing of this owner's manual, including changes in standard or optional content.

Refer to the purchase documentation relating to your specific vehicle to confirm the features.

Keep this manual in the vehicle for quick reference.

Using this Manual

To quickly locate information about the vehicle, use the Index in the back of the manual. It is an alphabetical list of what is in the manual and the page number where it can be found.

Danger, Warning, and Caution

Warning messages found on vehicle labels and in this manual describe hazards and what to do to avoid or reduce them.

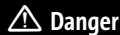

Danger indicates a hazard with a high level of risk which will result in serious injury or death.

2 Introduction

Warning

Warning indicates a hazard that could result in injury or death.

Caution

Caution indicates a hazard that could result in property or vehicle damage.



A circle with a slash through it is a safety symbol which means “Do not,” “Do not do this,” or “Do not let this happen.”

Symbols

The vehicle has components and labels that use symbols instead of text. Symbols are shown along with the text describing the operation or information relating to a specific component, control, message, gauge, or indicator.

 : Shown when the owner's manual has additional instructions or information.

 : Shown when the service manual has additional instructions or information.

⇨ : Shown when there is more information on another page — “see page.”

Vehicle Symbol Chart

Here are some additional symbols that may be found on the vehicle and what they mean. See the features in this manual for information.

 : Air Conditioning System

 : Air Conditioning Refrigerant Oil

 : Airbag Readiness Light

 : Antilock Brake System (ABS)

 : Brake System Warning Light

 : Dispose of Used Components Properly

 : Do Not Apply High Pressure Water

 : Energy Usage and Charge Mode Selection

 : Flame/Fire Prohibited

 : Flammable

 : First Responder

 : Forward Collision Alert

 : Fuse Block Cover Lock Location

 : Fuses

 : High Voltage

 : ISOFIX/LATCH System Child Restraints

 : Keep Fuse Block Covers Properly Installed

 : Lane Change Alert

 : Lane Departure Warning

 : Lane Keep Assist

 : Park Assist

 : Pedestrian Ahead Indicator

 : Power

 : Rear Cross Traffic Alert

 : Registered Technician

 : Remote Vehicle Start

 : Risk of Electrical Fire

 : Seat Belt Reminders

 : Service Vehicle Soon

 : Side Blind Zone Alert

 : Tyre Pressure Monitor

 : Traction Control/StabiliTrak/Electronic Stability Control (ESC)

 : Under Pressure

 : Vehicle Ahead Indicator

 : Vehicle Ready

Instrument Panel Overview

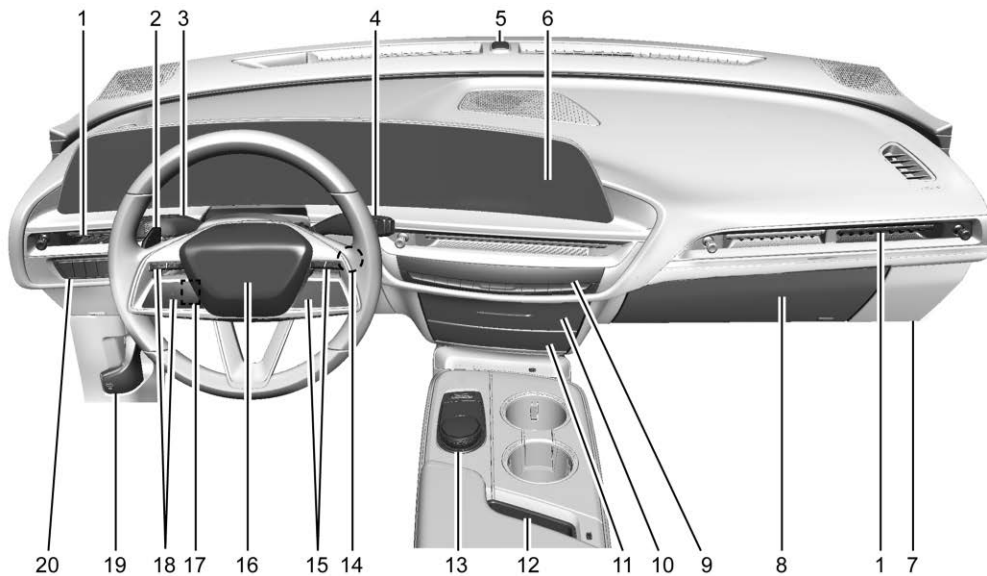

1. *Air Vents* ⇨ 145.
2. *Regenerative Braking* ⇨ 169.
3. *Indicator Lever*. See *Turn and Lane-Change Signals* ⇨ 117.
Windscreen Wiper/Washer ⇨ 81.
4. *Shift Lever*. See *Electric Drive Unit* ⇨ 162.
5. *Light Sensor*. See *Automatic Headlamp System* ⇨ 115.
6. *Infotainment Display*. See *Using the System* ⇨ 124.
Instrument Cluster ⇨ 87.
7. *Instrument Panel Fuse Block* ⇨ 260.
8. *Glove Box* ⇨ 74.
9. *Dual Automatic Climate Control System* ⇨ 140.
10. *Sliding Storage Tray*. See *Instrument Panel Storage* ⇨ 74 (If Equipped).
11. *Lower Storage*. See *Instrument Panel Storage* ⇨ 74 (If Equipped).
12. *Wireless Charging* ⇨ 84.
13. *Infotainment Controls*. See *Overview* ⇨ 123.
14. *Power Button* ⇨ 159 (Out of View).
15. *Radio Controls*. See *Steering Wheel Controls* ⇨ 124.
16. *Horn* ⇨ 81.
17. *Steering Wheel Adjustment* ⇨ 80 (Out of View).
18. *Adaptive Cruise Control (Advanced)* ⇨ 173.
Forward Collision Alert (FCA) System ⇨ 196 (If Equipped).
Heated Steering Wheel ⇨ 80.
19. *Bonnet Release*. See *Bonnet* ⇨ 243.
20. *Electric Parking Brake* ⇨ 167.
Lane Keep Assist (LKA) ⇨ 210 (If Equipped).
Automatic Vehicle Hold (AVH) ⇨ 168.
Instrument Panel Illumination Control ⇨ 118.

Keys, Doors, and Windows

Keys and Locks

Keys	6
Remote Key	7
Remote Key Operation	7
Remote Start	12
Door Locks	13
Power Door Locks	14
Delayed Locking	14
Automatic Door Locks	15
Lockout Protection	15
Safety Locks	15
Digital Key	15

Doors

Tailgate	17
----------------	----

Vehicle Security

Vehicle Security	23
Vehicle Alarm System	23
Steering Column Lock	25
Anti-theft Locking System	25
Immobiliser Operation	25

Exterior Mirrors

Convex Mirrors	26
Power Mirrors	26
Folding Mirrors	27

Heated Mirrors	28
----------------------	----

Interior Mirrors

Interior Rearview Mirrors	28
Manual Rearview Mirror	28
Automatic Dimming Rearview Mirror ...	28
Rear Camera Mirror	28

Windows

Windows	30
Power Windows	31
Sun Visors	32

Roof

Sunroof	32
---------------	----

Keys and Locks

Keys



Warning

Leaving children in a vehicle with a remote key is dangerous and children or others could be seriously injured or killed. They could operate the power windows or other controls or make the vehicle move. The windows will function with the remote key in the vehicle, and children or others could be caught in the path of a closing window. Do not leave children in a vehicle with a remote key.



The mechanical key that is inside of the remote key can be used for all locks.



To remove the mechanical key, press the button near the bottom of the remote key, and pull the key out. Never pull the mechanical key out without pressing the button.

If it becomes difficult to turn the key, inspect the key blade for debris. Periodically, clean the key with a brush or a toothpick.

See your Cadillac Brand Ambassador if a new key is needed.

Remote Key

If there is a decrease in the remote key operating range:

- Check the distance. The remote key may be too far from the vehicle.
- Check the location. Other vehicles or objects may be blocking the signal.
- Check the remote key's battery. See "Battery Replacement" later in this section.
- If the remote key is still not working correctly, see your Cadillac Brand Ambassador or a qualified technician for service.

Remote Key Operation

The Keyless Access system allows for vehicle entry when the remote key is within 1 m (3 ft). See "Keyless Access Operation" following.

The remote key functions may work up to 60 m (197 ft) away from the vehicle.

Other conditions can impact the performance of the remote key. See *Remote Key* ⇨ 7.



 : Press to lock all doors.

If enabled, the indicators may flash and/or the horn may sound on the second press to indicate locking. To view available settings from the infotainment screen, touch Settings > Vehicle > Remote Lock, Unlock, Start.

If the driver door is open when  is pressed, all doors will lock and the driver door will immediately unlock, if enabled. To view available settings from the infotainment screen, touch Settings > Vehicle > Remote Lock, Unlock, Start.

If the passenger door is open when  is pressed, all doors lock.

8 Keys, Doors, and Windows

If equipped with auto mirror folding, double press and hold  for one second to fold the mirrors, if enabled. To view available settings from the infotainment screen, touch Settings > Vehicle > Comfort and Convenience.

Pressing  may also arm the alarm system. See *Vehicle Alarm System* ⇨ 23.

 : Press to unlock the driver door. Press unlock again within three seconds to unlock all doors. The remote key can be programmed to unlock all doors on the first button press. To view available settings from the infotainment screen, touch Settings > Vehicle > Remote Lock, Unlock, Start.



If enabled, the indicator lamps flash twice to indicate that the unlocking has occurred. The exterior lamps may also be programmed to turn on. To view available settings from the infotainment screen, touch Settings > Vehicle > Remote Lock, Unlock, Start.



If equipped with auto mirror unfolding, double press and hold  until the mirrors fully open. To view available settings from the infotainment screen, touch Settings > Vehicle > Comfort and Convenience.

Pressing  will disarm the alarm system. See *Vehicle Alarm System* ⇨ 23.

 : Press twice to open or close the tailgate. Press once to stop the liftgate from moving. The vehicle must be in P (Park).

 : Press and release one time to initiate vehicle locator. The exterior lamps flash and the horn chirps three times.

Press and hold  for at least three seconds to sound the panic alarm. The horn sounds and the indicators flash for about 30 seconds or until  is pressed again or the vehicle is started.

 : Press and release  and then immediately press and hold  for at least four seconds to start the vehicle's heating or air conditioning systems and rear window demister from outside the vehicle using the remote key. See *Remote Start* ⇨ 12.

Keyless Access Operation

The Keyless Access system allows the doors and tailgate to be unlocked without pressing the remote key button. The remote key must be within 1 m (3 ft) of the tailgate or door being opened.

Doors can be programmed to lock after exiting the vehicle through Passive locking or delayed locking. The remote key can also be used to lock the doors

Keyless Access can be programmed to unlock all doors when the driver door handle is pulled. All doors will unlock when any non-driver door handle is pulled regardless of the current setting. To view available settings from the infotainment screen, touch Settings > Vehicle > Remote Lock, Unlock, Start.

Keyless Unlocking from the Driver Door

When the doors are locked and the remote key is within 1 m (3 ft) of the driver door handle, pulling the handle will unlock and unlatch the driver door.

If the door handle is retracted and the remote key is within 1 m (3 ft) of the driver door, press the front of the door handle to deploy it.

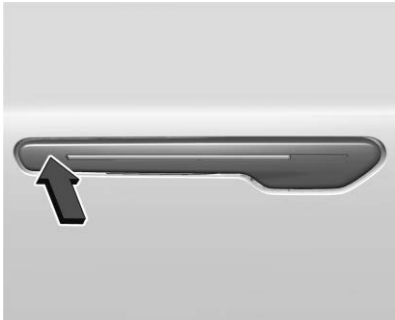

All outside door handles will deploy whenever the doors are unlocked, or when any door is opened or closed. The handles can also be programmed to deploy when the remote key approaches. To view available settings from the infotainment screen, touch Settings > Vehicle > Remote Lock, Unlock, Start.

All outside door handles will retract whenever the doors are locked, or after a short time.

Keyless Unlocking/Locking from Passenger Doors



When the doors are locked and the remote key is within 1 m (3 ft) of the door, pulling a handle will unlatch the door and unlock all doors.

If the door handle is retracted and the remote key is within 1 m (3 ft) of a passenger door, press the front of the handle to deploy it. Pressing the handle will also unlock all other doors.



Disable/Enable Keyless Unlocking of Exterior Door Handles and Tailgate

If equipped, keyless unlocking of the exterior door handles and tailgate can be disabled and enabled.

Disabling Keyless Unlocking:

With the vehicle off, press and hold  and  on the remote key at the same time for approximately three seconds. The indicator lamps will flash four times quickly to indicate access is disabled. Using any exterior handle to unlock the doors or open the tailgate will cause the indicator lamps to flash four times quickly, indicating access is disabled. If disabled, disarm the alarm system before starting the vehicle.

Enabling Keyless Unlocking:

With the vehicle off, press and hold  and  on the remote key at the same time for approximately three seconds. The indicator lamps will flash twice quickly to indicate access is enabled.

Passive Locking

The Keyless Access system will lock the vehicle several seconds after all doors are closed, if the vehicle is off and at least one remote key has been removed from the interior or none remain in the interior.

If other electronic devices interfere with the remote key signal, the vehicle may not detect the remote key inside the vehicle.

If passive locking is enabled, the doors may lock with the remote key inside the vehicle. Do not leave the remote key in an unattended vehicle.

To view available settings from the infotainment screen, touch Settings > Vehicle > Power Door Locks.

Temporary Disable of Passive Locking

Temporarily disable passive locking by pressing and holding  on the interior door switch with a door open for at least

10 Keys, Doors, and Windows

four seconds, or until three chimes are heard. Passive locking will then remain disabled until  on the interior door is pressed, or until the vehicle is started.

Remote Left In Vehicle Alert

When the vehicle is turned off and a remote key is left in the vehicle, the horn will chirp three times after all doors are closed.

To view available settings from the infotainment screen, touch Settings > Vehicle > Remote Lock, Unlock, Start.

Remote Removed From Vehicle Alert

If the vehicle is on with a door open, and then all doors are closed, the vehicle will check for remote keys inside. If a remote key is not detected, the Driver Information Center (DIC) will display NO KEY FOUND and the horn will chirp three times.

This occurs only once each time the vehicle is driven.

To view available settings from the infotainment screen, touch Settings > Vehicle > Remote Lock, Unlock, Start.

Keyless Tailgate Opening

Press the touch pad on the underside of the tailgate glass and lift up to open if the remote key is within 1 m (3 ft) and the doors are locked. If the doors are unlocked, the remote key is not required to open the tailgate. See *Tailgate* ⇨ 17.

Key Access

To access a vehicle with a weak remote key battery, see *Door Locks* ⇨ 13.

Programming Remote Keys to the Vehicle

Only remote keys programmed to the vehicle will work. If a remote key is lost or stolen, a replacement can be purchased and programmed through your Cadillac Service Centre. The vehicle can be reprogrammed so that lost or stolen remote keys no longer work. Any remaining remote keys will need to be reprogrammed. Each vehicle can have up to eight remote keys matched to it.

Starting the Vehicle with a Low Remote Key Battery

For improved Vehicle security, the remote key is equipped with a motion sensor. When starting the vehicle, if the remote key has been idle for an extended period of time,

the DIC may display KEY IN SLEEP MODE, MOVE KEY, THEN START. Move the remote key slightly and try starting the vehicle.

If the remote key battery is weak or if there is interference with the signal, the DIC may display NO KEY FOUND, REPLACE BATTERY IN KEY or NO REMOTE KEY WAS DETECTED PLACE KEY IN KEY POCKET THEN START YOUR VEHICLE when starting the vehicle.

To start the vehicle:

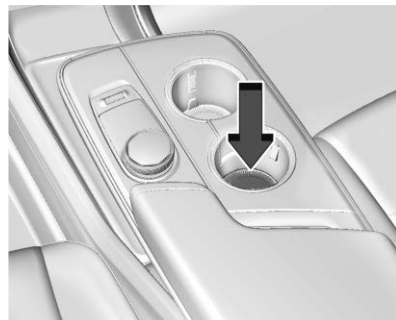

1. Place the remote key in the rear cupholder with the buttons facing down.
2. With the vehicle in P (Park) or N (Neutral), press the brake pedal and press POWER . Replace the remote key battery as soon as possible.

Battery Replacement**Warning**

Never allow children to play with the remote key. The remote key contains a small battery, which can be a choking hazard. If swallowed, internal burns can occur, resulting in severe injury or death. Seek medical attention immediately if a battery is swallowed.

Warning

To avoid personal injury, do not touch metal surfaces on the remote key when it has been exposed to extreme heat. These surfaces can be hot to the touch at temperatures above 59 °C (138 °F).

Caution

When replacing the battery, do not touch any of the circuitry on the remote key. Static from your body could damage the remote key.

Caution

Always replace the battery with the correct type. Replacing the battery with an incorrect type could potentially create a risk of battery explosion. Dispose of used batteries according to instructions and local laws. Do not attempt to burn, crush, or cut the used battery, and avoid exposing the battery to environments with extremely low air pressures or high temperatures.

Caution

If the remote key is not reassembled properly, liquids could enter the housing and damage the circuitry, resulting in a remote key malfunction and/or failure. To prevent damage, always follow the steps for remote key reassembly in this manual to ensure the remote key is sealed properly whenever the remote key is opened.

Replace the battery if the DIC displays
REPLACE BATTERY IN KEY.

The battery is not rechargeable. To replace the battery:



1. Press the button on the side of the remote key near the bottom and pull the mechanical key out. Never pull the mechanical key out without pressing the button.



2. Use the mechanical key blade in the slot to remove the battery cover by hand.

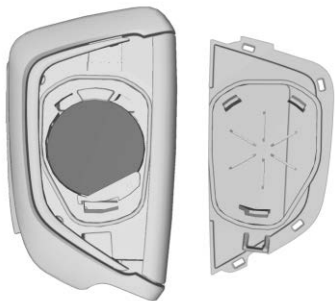

3. Remove the battery cover.

4. Pull the seal by pulling on the tab to access the battery.
5. Remove the old battery. Do not use a metal object.
6. Insert the new battery, positive side facing up. Replace with a CR2450 Lithium or equivalent battery.
7. Place the seal back into the groove around the battery compartment.
8. Replace the battery cover by snapping it back into the remote key.
9. Reinsert the mechanical key.

Remote Start

This feature starts the heating or air conditioning systems and the rear window demister from outside the vehicle.

If the outside temperature is below 7°C (45°F), and the rear window demister is on, the area of the windscreen beneath the windscreen wipers will warm up to melt accumulated snow or ice.

Use remote start to heat or cool the interior when the vehicle is plugged in to maximise electric range by utilising electricity from the electrical socket. Normal system operation will return after the vehicle has been turned on.

 : This button is on the remote key.

The climate control system will use the previous settings during a remote start. The rear demist may come on during a remote start based on cold ambient conditions. The rear demist indicator light will not come on during a remote start.

Laws in some local communities may restrict the use of remote starters. For example, some laws require a person using remote start to have the vehicle in view. Check local regulations for any requirements.

The vehicle cannot be remote started if:

- The remote key is in the vehicle.
- The bonnet is open.
- The total 60 minutes of remote start time has been used.
- The hazard warning lights are on.
- The vehicle is not in P (Park).
- The vehicle is already started.

If the battery level is low, do not use the remote start feature. The battery may fully deplete.

The remote key range may be less while the vehicle is running.

Other conditions may affect the range and performance of the remote key. See *Remote Key* ⇨ 7.

Starting the Vehicle Using Remote Start

Press  twice on the remote key. The indicator lamps will flash to confirm the remote start request was received. During the remote start, the parking lights will remain on as long as the vehicle is on.

The vehicle will turn off after 60 minutes, unless you stop the remote start before remote start cycle has completed or the vehicle is turned on.

Hold the brake pedal and press POWER  to drive.

Extending Remote Start Time

Remote start can be used for up to 60 minutes of total remote start time.

After a remote start of 60 minutes, or multiple shorter starts totalling 60 minutes, the vehicle must be started and then turned off before the remote start can be used again.

Cancelling a Remote Start

To cancel a remote start, do one of the following:

- Press . The parking lamps will turn off.
- Turn on the hazard warning lights.
- Turn the vehicle on and then off.

Door Locks

Warning

Unlocked doors can be dangerous.

- Passengers, especially children, can easily open the doors and fall out of a moving vehicle. The doors can be unlocked and opened while the vehicle is moving. The chance of being thrown out of the vehicle in a crash is increased if the doors are not locked. So, all passengers should wear seat belts properly and the doors should be locked whenever the vehicle is driven.
- Young children who get into unlocked vehicles may be unable to get out. A child can be overcome by extreme heat and can suffer permanent injuries



(Continued)

Warning (Continued)

or even death from heat stroke. Always lock the vehicle whenever leaving it.



- Outsiders can easily enter through an unlocked door when you slow down or stop the vehicle. Locking the doors can help prevent this from happening.

To lock or unlock the doors from outside the vehicle:

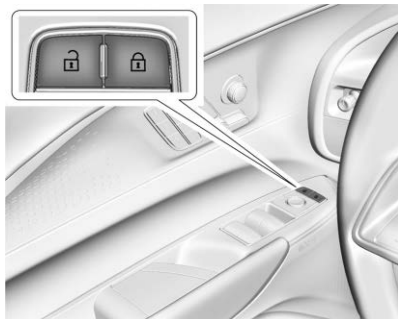
- Use the key in the tailgate to lock and unlock the door without the remote key. See *Tailgate* ⇨ 17.
- Press  or  on the remote key to lock and unlock the doors.



To lock or unlock the doors from inside the vehicle:

- Press  or  on the power door lock switch.
- Pull the door handle up. It is located on the door trim. Pull a front door handle once to unlock and open it. Pull a rear door handle once to unlock it and again to open it.

Do not pull the door handles while the vehicle is in motion. Always use safety locks when passengers are in the rear seats. See *Safety Locks* ⇨ 15.

Keyless Access

The remote key must be within 1 m (3 ft) of the tailgate or door being opened. Pull on the presented handle to open. See “Keyless Access Operation” in *Remote Key Operation* ⇨ 7.

Opening a Door from the Exterior

The door handles are power operated and cannot be used to open the vehicle unless one of the following occurs:

- When the vehicle detects a remote key approaching
- Whenever the doors are unlocked
- When the deploy switch is pressed and the doors are unlocked
- When a door is opened or closed.

The power door handles will remain pivoted outward for approximately two minutes, unless the vehicle is locked or begins moving. The timer is reset if any of the conditions listed above are met.

Power Door Locks



 : Press to unlock the doors.

 : Press to lock the doors.



Locking and unlocking the doors will also unlock the tailgate. See *Tailgate* ⇨ 17.

Delayed Locking

This feature delays the locking of the doors until five seconds after all doors are closed.

When  is pressed on the power door lock switch while the door is open, a chime will sound three times indicating delayed locking is active.

The doors will lock automatically five seconds after all doors are closed. If a door is reopened before that time, the five-second timer will reset when all doors are closed again.

Press  on the door lock switch again or press  on the remote key to lock the doors immediately.

To view available settings from the infotainment home screen, touch Settings > Vehicle > Power Door Locks.

Automatic Door Locks

The vehicle is programmed to lock the doors when all doors are closed, the vehicle is on, and the shift switch is out of P (Park).

If a vehicle door is unlocked and then opened and closed, the doors will lock either when your foot is removed from the brake or the vehicle speed becomes faster than 13 km/h (8 mph).

To unlock the doors:

- Press  on a door.
- Shift the vehicle into P (Park).

Automatic door locking can be programmed. To view available settings for this feature, touch the Settings icon on the infotainment

home page. Select “Vehicle” to display the list of available options and select “Power Door Locks”.

Lockout Protection

This feature protects you from locking remote keys in the vehicle.

When the lock button is pressed and the vehicle is on, with the driver door open, all of the doors will lock and then the driver door will unlock.

If the vehicle is off and locking is requested while a door is open, when all doors are closed the vehicle will check for remote keys inside. If a remote key is detected and the number of remote keys inside has not reduced, the driver door will unlock and the horn will sound three times.

This can be manually overridden by pressing and holding  on the power door lock switch.

Safety Locks

The rear door safety locks prevent passengers from opening the rear doors from inside the vehicle.

To activate the safety locks:

1. Touch the settings icon on the infotainment display.
2. Select Controls.
3. Touch DRIVE & PARK and then Child Safety Locks.
4. Select Off or On to activate or deactivate the safety locks.

Digital Key

If equipped and enabled, the Digital Key feature allows you to access and operate the vehicle using a smartphone. Many of the functions performed by a remote key can also be done using a Digital Key. See *Remote Key Operation* ⇨ 7.

Digital Key communicates with the vehicle using Bluetooth technology, which is less secure than a traditional remote key.

Only certain smartphones support Digital Key. Please see the myCadillac app to see if your device is compatible.

If the smartphone battery is weak or if there is interference with the signal, the Driver Information Centre (DIC) may display NO KEY FOUND or NO REMOTE KEY WAS DETECTED, PLACE KEY IN KEY POCKET THEN

START YOUR VEHICLE when starting the vehicle. Charge the smartphone battery as soon as possible.

You can use the myCadillac mobile app to pair, manage, or delete your Digital Key.

If the Digital Key is not working:

- Check the distance. The smartphone may be too far from the vehicle.
- Check the location. Other vehicles or objects may be blocking the signal. Your body could also impact the signal. Hold the smartphone in your hand, away from your body, and toward the vehicle for best results.
- Check that the smartphone is turned on and has sufficient battery power.
- Check the connection. Your smartphone's Bluetooth connection must be enabled.
- Check the myCadillac app. Ensure that it is open. Try relaunching the app if it is open but is still not working.

Setting up Digital Key

Digital Key is only available with an OnStar account associated with the vehicle.

1. Log in to your OnStar account in the MyCadillac mobile app.

2. Select the Digital Key menu option, and follow the steps on your screen to pair your phone.

Using Your Digital Key

Digital Key allows you to:

- Use keyless access features to lock and unlock the vehicle's doors, and access the rear compartments without a remote key. See "Keyless Access Operation" under *Remote Key Operation* ⇨ 7.
- Start the vehicle with just your phone present.
- Use remote commands in the myCadillac app to lock, unlock, and remote start the vehicle.

Digital Key Personal Identification Number (PIN)

Warning

A PIN may prevent unintended or unauthorised starting and movement of your vehicle that may result in serious injury or death.

(Continued)

Warning (Continued)

Your vehicle may be started if the mobile device that is paired with your vehicle is outside your vehicle, or if unauthorised parties manipulate the wireless Bluetooth signals between your paired smartphone and your vehicle.

A PIN will not prevent unauthorised entry into your vehicle if it is unlocked using Digital Key.

As an added security measure, you will have the option to set up a PIN to be used with the Digital Key.

When a PIN is enabled, you will be prompted to enter the PIN on your infotainment screen before starting your vehicle. After entering your PIN successfully, the vehicle can be started for a short period of time. If you do not start your vehicle within that time, you will be prompted for your PIN again.

Even if PIN to Start is enabled, you can still start your vehicle without entering a PIN if a remote key is in the vehicle, or by using your key card. See "Key Card" later in this section.

PIN Settings

If you forget your PIN, would like to change your PIN, or would like to enable/disable your PIN, you can do so via the Digital Key menu in your myCadillac app.

PIN Lockout

If the PIN is entered incorrectly too many times, you will need to wait several minutes before attempting to enter your PIN again. You can still start your vehicle by using a remote key or key card. You may also reset your PIN or disable the PIN setting via the Digital Key menu in your myCadillac app.

Key Card

Your vehicle may be equipped with a key card that unlocks, locks, and starts the vehicle. The key card works by tapping it on the location of the vehicle shown on the back of the key card.

It is highly recommended to carry a key card as a back up to the Digital Key in case the Digital Key battery is weak or there is interference to the signal.

Only key cards programmed to the vehicle will work. If a key card is lost or stolen, a replacement can be purchased and programmed through your Cadillac Brand

Ambassador. To prevent lost or stolen key cards from being able to operate the vehicle, see your Cadillac Brand Ambassador.

Each vehicle can have up to eight key cards programmed to it.

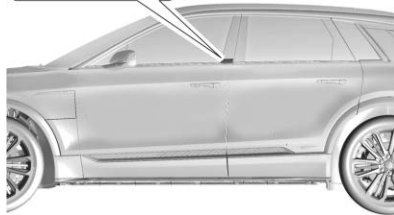
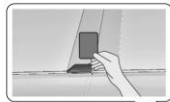

Unlocking with the Key Card

Tap your key card on the rectangular symbol on the driver door near the edge of the window to unlock the driver door. Only the driver door may be unlocked this way. See *Door Locks* ⇨ 13 for how to unlock the other doors and rear compartment.

Locking with the Key Card

With all doors closed, the vehicle off, and any door unlocked, tap your key card on the rectangular symbol on the driver door near the edge of the window to lock all doors.

Starting with the Key Card



You can start your vehicle for a short period after unlocking it with your key card. If the period has ended, you will need to unlock the vehicle with the key card again to start your vehicle.



Doors

Tailgate

Caution

To avoid damage to the tailgate or tailgate glass, make sure the area above and behind the tailgate is clear before opening it.

To lock or unlock the tailgate from the outside, press  or  on the remote key.

To lock or unlock the tailgate from the inside, press  or  on the instrument panel.

Power Tailgate Operation

Warning

You or others could be injured if caught in the path of the power tailgate. Make sure there is no one in the way of the tailgate as it is opening and closing.

Caution

Driving with an open and unsecured tailgate may result in damage to the power tailgate components.

Power Tailgate Mode Selection

To view available settings from the infotainment screen, touch Settings > Vehicle > Comfort and Convenience > Power Rear Gate Opening.

The available selections:

Maximum : Opens to the maximum height.

Custom : Opens to a reduced height that can be set between a programmed height to fully open. See “Setting the Customer Opening Height” later in this section.

Use to prevent the tailgate from opening into overhead obstructions, such as a garage door or roof-mounted cargo. The tailgate can be manually opened all the way.

Off : Opens manually only.

Select Maximum or Custom to power open or close the tailgate.

To open or close the tailgate using the remote key, press  twice quickly until the tailgate moves.

Operating the Power Tailgate from the Inside



Inside Door Switch

To open or close the tailgate from the inside, press .

Keyless Tailgate Opening

The remote key must be within 1 m (3 ft), when the doors are locked, to open the tailgate. If the doors are unlocked, the remote key is not required to open the tailgate.

Press the Cadillac emblem on the underside of the tailgate glass to power open the tailgate when the power tailgate mode is set to Maximum or Custom.

Press the Cadillac emblem on the underside of the tailgate glass and lift up to open when the power tailgate mode is set to Off.



See “Power Tailgate Mode Selection” earlier in this section.



To open the tailgate, press the Cadillac emblem.



When closing the tailgate, press the button on the bottom of the gate.

Press any tailgate button, the Cadillac emblem, or  on the remote key while the tailgate is moving to stop it. Pressing any tailgate button or pressing  twice quickly on the remote key restarts the operation in the reverse direction. Pressing the Cadillac emblem will restart the motion, but only in the opening direction.

Caution

Manually operating the tailgate during a power open or close can damage the tailgate system. Always wait for the power operation to complete before manually operating the tailgate.

The power tailgate may be temporarily disabled in extremely low temperatures, or after repeated opening and closings over a short period of time. If this occurs, the tailgate can still be operated manually.

If the vehicle is shifted out of P (Park) while the power tailgate operation is in progress, the operation will continue to completion. If the vehicle is driven before the tailgate has completed moving, the tailgate may stop or reverse direction. Check for Driver Information Centre (DIC) messages, and make sure that the tailgate is closed and latched before driving.

Falling Tailgate Detection

If the power tailgate automatically closes after a power opening cycle, it indicates that the system is reacting to excess weight on the tailgate or a possible support strut failure. A repetitive chime will sound while the falling tailgate detection feature is

operating. Remove any excess weight. If the tailgate continues to automatically close after opening, see your Cadillac Brand Ambassador for service before using the power tailgate.

Interfering with the power tailgate motion or manually closing the tailgate too quickly after power opening may resemble a support strut failure. This could also activate the falling tailgate detection feature. Allow the tailgate to complete its operation and wait a few seconds before manually closing the tailgate.

Obstacle Detection Features

If the tailgate encounters an obstacle during a power open or close cycle, the tailgate will automatically reverse direction and move a short distance away from the obstacle. After removing the obstruction, the power tailgate operation can be used again. If the tailgate encounters multiple obstacles on the same power cycle, the power function will deactivate. After removing the obstructions, manually close the tailgate. This will allow normal power operation functions to resume.

20 Keys, Doors, and Windows

If the vehicle is locked while the tailgate is closing, and an obstacle is encountered that prevents the tailgate from completely closing, the horn will sound as an alert that the tailgate did not close.

Setting the Custom Opening Height

To change the position the tailgate stops at when opening:

1. Select MAX or Custom mode and power open the tailgate.
2. Stop the tailgate movement at the desired height by pressing any tailgate button. Manually adjust the liftgate position if needed.
3. Press and hold  on the bottom edge of the tailgate next to the latch on the outside of the tailgate until the indicators flash and a beep sounds. This indicates the setting has been recorded.

The liftgate cannot be set below a minimum programmable height. If there is no light flash or sound, then the height adjustment may be too low.

Tailgate Key Lock Cylinder Access (In Case of Dead Battery)



The tailgate can be used to access the inside of the vehicle cabin for service. To access the tailgate lock cylinder, insert the mechanical key into the cylinder and turn to unlock. See *Keys* ⇨ 6. See *Anti-theft Locking System* ⇨ 25.

Warning

Do not enter the vehicle cabin using the tailgate key lock cylinder if the anti-theft locking system is engaged. The doors cannot be opened from the inside. You could become trapped in the vehicle if the tailgate is closed. Entrapment in an anti-theft locked vehicle can lead to serious injury or death.

Free-Turning Locks

The key cylinder turns freely when either the wrong key is used, or the correct key is not fully inserted. The free-turning lock feature prevents the lock cylinder from being forced open. To reset the lock cylinder, ensure the correct key is fully inserted into the lock cylinder and then rotate the key until you feel the lock cylinder click back into place. Remove the key and reinsert fully. Rotate the key to unlock the vehicle.

Hands-Free Operation

If equipped, the tailgate may be operated with a kicking motion near the centre of the rear bumper at the location of the projected logo.

The remote key must be within 1 m (3 ft.) of the rear bumper to operate the power tailgate handsfree.

The hands-free feature will not work while the tailgate is moving. To stop the tailgate while in motion use one of the tailgate switches.

The hands-free feature can be customised. To view available settings from the infotainment screen, touch Settings > Vehicle > Comfort and Convenience. Choose from the following:

On-Open and Close : The kicking motion is activated to both open and close the tailgate.

On-Open Only : The kicking motion is activated to only open the tailgate.

Off : The feature is disabled.



To operate, move your foot in a forward kicking motion under the left side of the rear bumper, at the location of the projected logo, then pull it back. Then step back. The kick must come within 14 cm (6 in) of the rear bumper to activate.

- Do not sweep your foot side to side.
- Do not keep your foot under the bumper; the tailgate will not activate.

- Do not touch the tailgate until it has stopped moving.
- This feature may be temporarily disabled under some conditions. If the tailgate does not respond to the kick, open or close the tailgate by another method or start the vehicle. The feature will be re-enabled.

When closing the tailgate using this feature, there will be a short delay. The tail lights will flash and a chime will sound. Step away from the tailgate before it starts moving.

Projected Logo

If equipped, a vehicle logo will be projected for one minute onto the ground near the rear bumper when an remote key is detected within approximately 2 m (6 ft) from the rear bumper. The projected logo may not be visible under brighter daytime conditions.

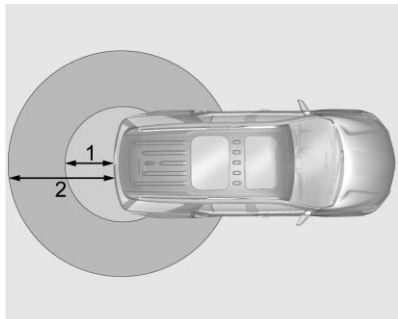

1. 1 m (3 ft) Hands-Free Operation Detection Zone
2. 2 m (6 ft) Projected Logo Detection Zone

The projected logo shows where to kick toward the rear bumper.

The projected logo will not be restarted using the same remote key unless it has been out of range for longer than 20 seconds.

If an remote key is again detected within approximately 2 m (6 ft) of the tailgate, or another kick has been detected, the one-minute timer will be reset.

The projected logo will not work under these conditions:

- The vehicle battery is low.
- The vehicle is not in P (Park).
- Hands Free Tailgate/Boot Control is set to Off in vehicle settings. To view available settings from the infotainment screen, touch Settings > Vehicle > Comfort and Convenience.
- Power tailgate is turned off.
- The vehicle remains parked for 72 hours or more, with no remote key use or Keyless Access operation. To re-enable, press any button on the remote key or open and close a vehicle door.

The projected logo will not work for a single remote key when a remote key:

- Has been left within approximately 5 m (15 ft) of the tailgate for several minutes.
- Has been left inside the vehicle and all vehicle doors are closed.
- Has approached the area outside of the tailgate five times within 10 minutes.

Lens Cleaning



If equipped, use a soft clean cloth to clean the lens.

Hands-Free Tailgate and Projected Logo Availability

Action	Hands-Free Tailgate	Projected Logo
Remote key entering projected logo detection zone	Operative	On for one minute
Remote key left inside projected logo detection zone for minimum of 10 minutes	Operative	Off until remote key button press or a door is opened and closed
Remote key brought in and out of projected logo detection zone five times or more within 10 minutes	Operative	Off for one hour or until remote key button press or a door is opened and closed
Vehicle remains parked for more than 72 hours	Operative	Off until remote key button press or a door is opened and closed
Vehicle battery is low	Non-operative	Off
Vehicle is not in P (Park)	Non-operative	Off
Power tailgate is turned off	Non-operative	Off
Hands-free tailgate is disabled in vehicle personalisation	Non-operative	Off



Vehicle Security

This vehicle has theft-deterrent features; however, they do not make the vehicle impossible to steal.

Vehicle Alarm System

Arming the Alarm System

1. Turn off the vehicle.
2. Lock the vehicle in one of three ways:
 - Use the remote key.

- Use the Keyless Access system.
 - With a door open, press  on the interior of the door.
3. After 30 seconds the alarm system will arm, and the indicator light will begin to slowly flash. Pressing  on the remote

key a second time will bypass the 30-second delay and immediately arm the alarm system.

The vehicle alarm system will not arm if the doors are locked with the mechanical key.

If the driver door is opened without first unlocking with the remote key, the horn will chirp and the lights will flash to indicate pre-alarm. If the vehicle is not started, or the door is not unlocked by pressing  on the remote key during the 10-second pre-alarm, the alarm will be activated.

The alarm will also be activated if a passenger door, the tailgate, or the bonnet is opened without first disarming the system. When the alarm is activated, the indicators flash and the horn sounds for about 30 seconds. The alarm system will then re-arm to monitor for the next unauthorised event.

Disarming the Alarm System

To disarm the alarm system or turn off the alarm if it has been activated:

- Press  on the remote key.
- Unlock the vehicle using the Keyless Access system.
- Start the vehicle.

To avoid setting off the alarm by accident:

- Lock the vehicle after all occupants have exited.
- Always unlock a door with the remote key, or use the Keyless Access system. Unlocking the driver door with the mechanical key will not disarm the system or turn off the alarm.

How to Detect a Tamper Condition

If  is pressed on the remote key and the horn chirps three times, an alarm occurred previously while the alarm system was armed.

If the alarm has been activated, a message will appear on the Driver Information Centre (DIC).

Power Sounder, Inclination Sensor and Intrusion Sensor

In addition to the standard theft-deterrent system features, this system may also have an inclination sensor and intrusion sensor.

The power sounder provides an audible alarm which is distinct from the vehicle horn. It has its own power source and can sound an alarm if the vehicle's battery is compromised.

The inclination sensor can set off the alarm if it senses movement of the vehicle, such as a change in vehicle orientation.

The intrusion sensor monitors the vehicle interior, and can activate the alarm if it senses unauthorised entry into the vehicle interior. Do not allow passengers or pets to remain in the vehicle when the intrusion sensor is activated.

Before arming the theft-deterrent system and activating the intrusion sensor:

- Make sure all doors and windows are completely closed.
- Secure any loose items such as a sunvisors.
- Make sure there are no obstructions blocking the sensors in the front overhead console.

Intrusion and Inclination Sensors Disable Switch

It is recommended that the intrusion and inclination sensors be deactivated if pets are left in the vehicle or the vehicle is being transported.

With the vehicle in turned on, press the off button to turn off the feature.

The indicator light may come on momentarily, or a message may display on the instrument cluster, indicating that these sensors have been disabled until the next time the system is armed.

Steering Column Lock

If equipped, the steering column lock is a theft-deterrent device. This feature locks the steering column when the vehicle is turned off and the driver door is opened, or when the driver door is opened and then the vehicle is turned off. The steering column unlocks when the vehicle is turned on.

The Driver Information Centre (DIC) may display one of these messages:

- A message to service the steering column lock indicates that an issue has been detected with the column lock feature and the vehicle should be serviced.
- A message that the steering column is locked indicates that the engine is still running, but the steering column is still locked. It is normal for the column to be locked during a remote start, but the column should unlock after the brake pedal is depressed and the vehicle is started. No message will display during a remote start.

- A message that the steering wheel must be turned and the vehicle must be started again indicates that the column lock mechanism is engaged, the column locking device was unable to unlock the steering column, and the vehicle did not start. If this happens, immediately turn the steering wheel from side to side to disengage the column lock. If this does not unlock the steering column, turn the vehicle off and open the driver door to reset the system. Then turn the vehicle on and immediately turn the steering wheel from side to side for about 15 seconds. In some cases, significant force may be needed to disengage the column.

To prevent the steering column lock from engaging, straighten the front wheels before turning off the vehicle.

Anti-theft Locking System

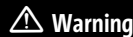

Do not use the system if there are people in the vehicle. The doors cannot be opened from the inside. Entrapment in an anti-theft locked vehicle can lead to serious injury or death.

The vehicle is equipped with an anti-theft locking function in addition to the standard door locks.

The anti-theft locking system is engaged whenever you press  on the remote key twice within five seconds with all doors closed and the vehicle off.

When the doors are secured with the anti-theft locking system, they cannot be unlocked or opened using the controls or handles inside the vehicle.

Press  on the remote key once to open the anti-theft locking system and unlock the driver door. Pressing the button again within five seconds will unlock all of the doors.

Immobiliser Operation

This vehicle has a passive theft-deterrent system.

The system does not have to be manually armed or disarmed.

The vehicle is automatically immobilised when the vehicle is turned off.

The immobilisation system is disarmed when the vehicle is turned and a valid remote key is present in the vehicle.



The security light, in the instrument cluster, comes on if there is a problem with arming or disarming the theft-deterrent system.

The system has one or more remote keys matched to an immobiliser control unit in the vehicle. Only a correctly matched remote key will start the vehicle. If the remote key is ever damaged, you may not be able to start your vehicle.

When trying to start the vehicle, the security light may come on briefly.

If the vehicle does not start and the security light stays on, there is a problem with the system. Turn the vehicle off and try again.

If the vehicle will not turn on or off, and the remote key appears to be undamaged, try another remote key. Or, you may try placing the remote key in the backup location. See *Remote Key Operation* ⇨ 7.

If the vehicle will not turn on or off with the other remote key or in the backup location, the vehicle needs service. If the

vehicle does turn on or off, the first remote key may be faulty. See your Cadillac Brand Ambassador.

It is possible for the immobiliser system to learn new or replacement remote keys. Up to eight remote keys can be programmed for the vehicle. To program additional remote keys, see “Programming Remote Keys to the Vehicle” under *Remote Key Operation* ⇨ 7.

Do not leave the remote key or device that disarms or deactivates the theft-deterrent system in the vehicle.

Do not modify or remove the system. The system may not work properly, and it could void the warranty.

Exterior Mirrors

Convex Mirrors

Warning

A convex mirror can make things, like other vehicles, look farther away than they really are. If you cut too sharply into the adjacent lane, you could hit a

(Continued)

Warning (Continued)



vehicle that is driving next to you. Check the inside mirror or glance over your shoulder before changing lanes.





The passenger side mirror is convex shaped so more can be seen from the driver seat.

Power Mirrors



To adjust the mirrors:

1. Press  or  to choose the driver or passenger mirror. An indicator will show the selected mirror.

2. Press one of the four arrows on the control pad while the indicator light on button  or  is illuminated, to move the mirror in the desired direction.
3. Adjust each outside mirror so that a little of the vehicle and the area behind it can be seen.
4. Press  or  again to deselect the mirror. If you do not deselect the mirror, the mirror adjustment will turn off after about one minute.

Folding Mirrors



To adjust power folding mirrors:

1. Press  to fold the mirrors inward.

2. Press  again to return the mirrors to the driving position.

The outside mirrors may automatically unfold when the vehicle is driven above 20 km/h (12 mph), but may be folded with the power folding mirror switch. If the vehicle speed is driven above 40 km/h (25 mph), they may automatically unfold and may not be refolded with the power folding mirror switch.

Resetting the Power Folding Mirrors

Reset the power folding mirrors if:

- The mirrors are accidentally obstructed while folding.
- They are accidentally manually folded/unfolded.
- The mirrors do not stay in the unfolded position.
- The mirrors vibrate at normal driving speeds.
- One mirror folds while the other unfolds.



Fold and unfold the mirrors one time using the mirror controls to reset them to their normal position. A noise may be heard during the resetting of the power folding mirrors. This sound is normal after a manual folding operation.

If one mirror folds while the other unfolds, fold and unfold the mirrors three times using the mirror controls to reset them to their normal position. A noise may be heard during the resetting of the power folding mirrors. This sound is normal after a manual folding operation.

Remote Mirror Folding

If the mirrors have been folded with the power folding mirror switch, they may not be unfolded by use of remote key.

If the mirrors have not been folded with the power folding mirror switch and the vehicle is in P (Park), they may be automatically folded/unfolded as follows:

- If doors are locked by pressing  on the remote key, the mirrors will fold. If doors are unlocked by pressing  on the remote key, the mirrors will unfold. See *Remote Key Operation* ⇨ 7.
- If doors are locked by pressing the door handle button, the mirrors will fold. If doors are unlocked by pressing the door handle button, the mirrors will unfold. See “Keyless Unlocking/Locking from the Driver Door” in *Remote Key Operation* ⇨ 7.

28 Keys, Doors, and Windows

- If passive locking is enabled and doors are locked by that feature, the mirrors will fold. See “Passive Locking” in *Remote Key Operation* ⇨ 7.

Lane Change Alert (LCA)

The vehicle may have LCA. See *Lane Change Alert (LCA)* ⇨ 204.

Indicator

The vehicle may have an indicator on the mirror housings. The indicator will flash when an indication is made or the hazard warning flashers are used.

Heated Mirrors

If equipped with heated mirrors,  will be present on both side mirrors. The symbol does not illuminate when the heated mirrors are active.

The rear window demister also heats the outside mirrors.

 : Press to heat the outside rearview mirrors. See “Rear Window Demister” under *Dual Automatic Climate Control System* ⇨ 140.

Interior Mirrors

Interior Rearview Mirrors

Adjust the rearview mirror for a clear view of the area behind your vehicle.

Do not spray glass cleaner directly on the mirror. Use a soft towel dampened with water.

Manual Rearview Mirror

If equipped, push the tab forward for daytime use and pull it for night-time use to avoid glare from the headlights from behind.

Automatic Dimming Rearview Mirror

If equipped, automatic dimming reduces the glare of headlamps from behind. The dimming feature comes on when the vehicle is started.

Rear Camera Mirror

If equipped, this automatic dimming mirror provides a wide angle camera view of the area behind the vehicle.

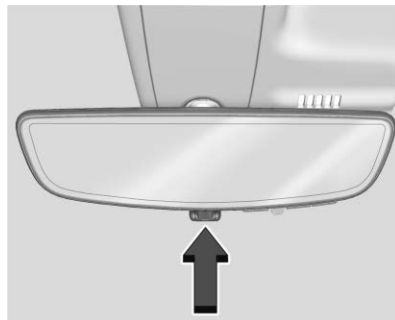

Pull the tab to turn on the display. Push the tab to turn it off. When off, the mirror is automatic dimming. Adjust the mirror for a clear view of the area behind the vehicle while the display is off.

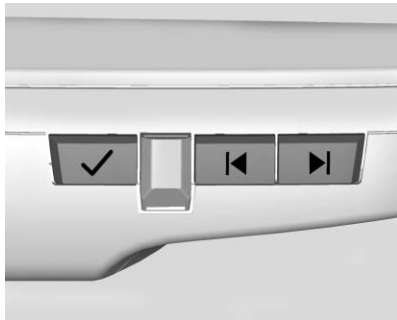

Press ✓ to scroll through the adjustment options.

Press ◀ and ▶ to adjust the settings using the indicators on the mirror. The indicators will remain visible for five seconds after the last button activation, and the settings will remain saved.

The adjustment options are:

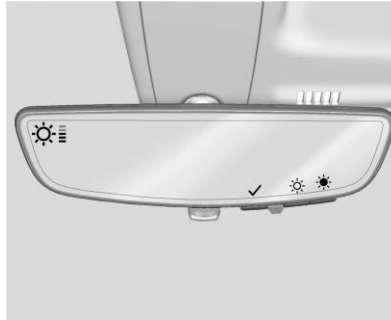

- Brightness

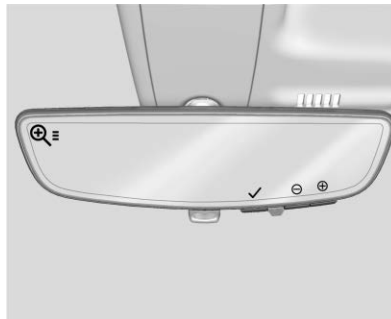

- Zoom

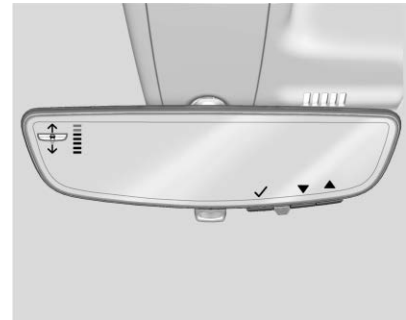

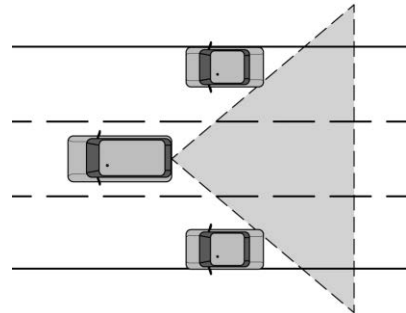

- Tilt

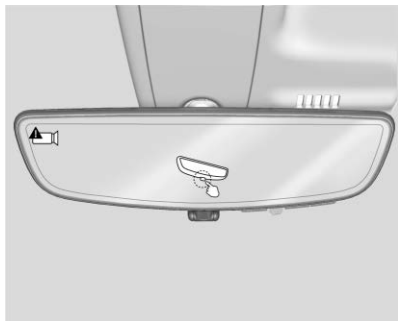

⚠ Warning

The Rear Camera Mirror (RCM) has a limited view. Portions of the road, vehicles, and other objects may not be seen. Do not drive or park the vehicle using only this camera. Objects may appear closer than they are. Check the outside mirrors or glance over your shoulder when making lane changes or merging. Failure to use proper care may result in injury, death, or vehicle damage.

Troubleshooting

See your Cadillac Service Centre for service if a blue screen and  are displayed in the mirror, and the display shuts off. Also, push the tab as indicated to return to the automatic dimming mode.

The Rear Camera Mirror may not work properly or display a clear image if:

- There is glare from the sun or headlights. This may obstruct objects from view. If needed, push the tab to turn off the display.
- Dirt, snow, or other debris blocks the camera lens. To clean the rear camera, see *Windscreen Wiper/Washer* ⇨ 81 or clean the lens with a soft damp cloth.

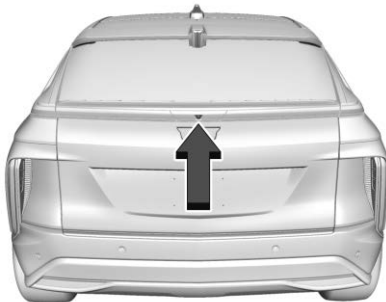

- The camera's mounting on the vehicle has been damaged, and/or the position or the mounting angle of the camera has changed.

Windows**⚠ Warning**

Never leave a child, a helpless adult, or a pet alone in a vehicle, especially with the windows closed in warm or hot weather.

They can be overcome by the extreme heat and suffer permanent injuries or even death from heat stroke.



The vehicle aerodynamics are designed to improve electric range performance. This may result in a pulsing sound when either rear window is down and the front windows are up. To reduce the sound, open a front window.

Power Windows

Warning

Children could be seriously injured or killed if caught in the path of a closing window. Never leave the remote key in a vehicle with children. When there are children in the rear seat, use the window lockout switch to prevent operation of the windows. See *Keys* ⇨ 6.



Press the switch to open the window. Pull the front of the switch up to close it.

The window switches on the driver door control all windows.

The power windows only operate with the vehicle on, or when Retained Accessory Power (RAP) is active.

Express Window Operation

The windows have an express feature which allows the windows to be lowered or raised without holding the switch. To automatically raise or lower the window, pull a window switch up or press it down all the way and release. Stop the window by pressing or pulling the switch in the same direction a

second time, or by briefly operating the switch to the first position in either direction.

Remote Window Operation

If equipped, this feature allows all the windows to be opened remotely. If enabled in vehicle personalization, press and hold  on the remote key. To view available settings from the infotainment screen, touch Settings > Vehicle > Remote Lock, Unlock, Start.

Safety Function

This is for vehicles with the express-up feature. If any object is in the path of the window when the express-up feature is active, the window will stop and auto-reverse to a preset position. Weather conditions may cause the window to auto-reverse. The window switch may be held up to the second position to close the window. The window will return to normal operation once the obstruction or condition is removed.

Safety Function Override

This is for vehicles with the express-up feature. If the battery on the vehicle has been recharged or disconnected, or is not

32 Keys, Doors, and Windows

working, the windows will need to be reprogrammed for the express-up feature to work. Before reprogramming, replace or recharge the vehicle's battery.

To program the driver window:

1. Close all doors with the vehicle on.
2. Press and hold the power window switch until the window is fully open.
3. Pull the power window switch up until the window is fully closed.
4. Continue holding the switch up for approximately two seconds after the window is completely closed.

Window Lockout

This feature prevents the rear passenger windows from operating, except from the driver position.

There is a button on the infotainment display used to enable or disable this feature.

Sun Visors

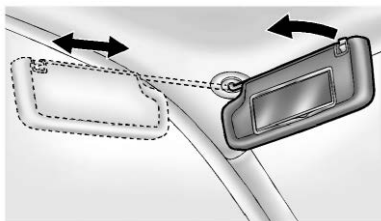

Pull the sun visor down to block glare. Detach the sun visor from the centre mount to pivot to the side window or, if equipped, extend along the rod.

Visor Vanity Mirror

The vehicle may have vanity mirrors and card holders on the reverse of the sun visors. Swing down the sun visor to expose the vanity mirror.

Roof



Sunroof





1. Sunroof Switch
2. Sunshade Switch

If equipped, the sunroof only operates when the vehicle is on or in Service Mode or when Retained Accessory Power (RAP) is active. See *Retained Accessory Power (RAP)* ⇨ 161.



Sunroof Switch Express-Open/



Express-Close : To express-open the sunroof, fully press and release  (1). Press the switch again to stop it. To express-close the sunroof, fully press and release  (1). Press the switch again to stop it.

If a roof rack is installed, the sunroof may not be able to open or close. To prevent damage to the sunroof, do not continually try to open or close the sunroof while the roof rack is present.

Open/Close (Manual Mode) : To open the sunroof, press and hold  (1) until the sunroof reaches the desired position. Press and hold  (1) to close it.

Vent : From the closed position, press  (1) to vent the sunroof.

Sunshade Switch Express-Open/ Express-Close : To express-open the sunshade, fully press and release  (2). To express-close the sunshade, fully press and release  (2). Press the switch again to stop it.

Open/Close : To open the sunshade, press and hold  (2) until the sunshade reaches the desired position. Press  (2) to close the sunshade.

When the sunroof is opened, an air deflector will automatically raise. The air deflector will retract when the sunroof is closed.

Automatic Reversal System

The sunroof has an automatic reversal system that is only active when the sunroof is operated in express-close mode.

If an object is in the path while express closing, the reversal system will detect an object, stop, and open the sunroof again slightly.

If frost or other conditions prevent closing, override the feature by closing the sunroof in manual mode. To stop the movement, release the switch.

In the event of closing difficulties like frost or other conditions, it is possible to override the reversal system. To override the reversal system, close in manual mode. To stop the movement, release the switch.

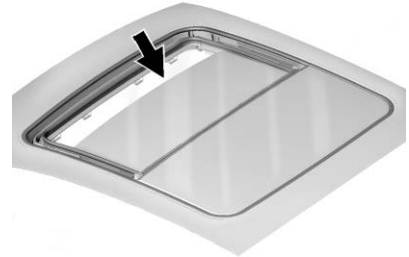

Dirt and debris may collect on the sunroof seal or in the track. This could cause an issue with sunroof operation or noise. It could also plug the water drainage system.

Periodically open the sunroof and remove any obstacles or loose debris. Wipe the sunroof seal and roof sealing area using a clean cloth, mild soap, and water. Do not remove grease from the sunroof.

Seats and Restraints

Head Restraints

Head Restraints 34

Front Seats

Power Seat Adjustment 35

Reclining Seat Backrests 36

Lumbar Adjustment 37

Massage 37

Memory Seats 38

Heated and Ventilated Front Seats 40

Rear Seats

Rear Seats 41

Heated Rear Seats 44

Seat Belts

Seat Belts 44

How to Wear Seat Belts Properly 45

Lap-Shoulder Belt 47

Seat Belt Use During Pregnancy 49

Safety System Check 49

Seat Belt Care 49

Replacing Seat Belt System Parts after a
Crash 50

Airbag System

Airbag System 50

Where Are the Airbags? 52

When Should an Airbag Inflate? 53

What Makes an Airbag Inflate? 53

How Does an Airbag Restrain? 54

What Will You See after an Airbag
Inflates? 54

Airbag On-Off Switch 55

Servicing the Airbag-Equipped
Vehicle 57

Adding Equipment to the
Airbag-Equipped Vehicle 58

Airbag System Check 58

Replacing Airbag System Parts after a
Crash 58

Child Restraints

Older Children 59

Infants and Young Children 60

Child Restraint Systems 61

Where to Put the Restraint 65

ISOFIX Child Restraint Systems 70

Securing Child Restraints 72

Head Restraints

Front Seats



Warning

With head restraints that are not installed and adjusted properly, there is a greater chance that occupants will suffer a neck/spinal injury in a crash. Do not drive until the head restraints for all occupants are installed and adjusted properly.

The vehicle's front seats have adjustable head restraints in the outboard seating positions.



Adjust the head restraint so that the top of the restraint is at the same height as the top of the occupant's head. This position reduces the chance of a neck injury in a crash.

The height of the head restraint can be adjusted.

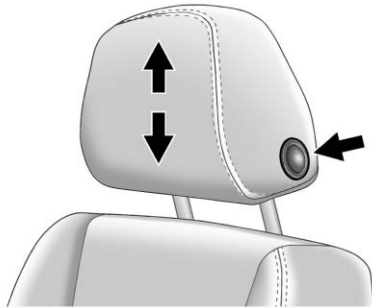

To raise or lower the head restraint, press the button located on the side of the head restraint, and pull up or push the head restraint down, and release the button. Pull and push on the head restraint after the button is released to make sure that it is locked in place.

The front seat outboard head restraints are not removable.

Rear Seats

Adjusting the Rear Head Restraint

The vehicle's rear seats have adjustable head restraints in all three seating positions.

The height of the head restraint can be adjusted. Pull the head restraint up to raise it. Try to move the head restraint to make sure that it is locked in place.

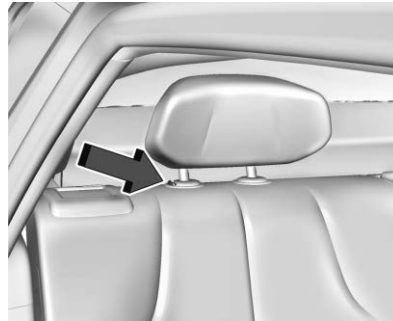

To lower the head restraint, press the button, located on the top of the seat backrest, and push the head restraint down. Try to move the head restraint after the button is released to make sure that it is locked in place.

Always adjust the head restraint so that the top of the restraint is at the same height as the top of the occupant's head.

Rear head restraints are not removable.

If you are installing a child restraint in the rear seat, see *ISOFIX Child Restraint Systems* ⇨ 70.

Front Seats

Power Seat Adjustment

Warning

You can lose control of the vehicle if you try to adjust a driver seat while the vehicle is moving. Adjust the driver seat only when the vehicle is not moving.

Warning

The power seats will work with the vehicle off. Children could operate the power seats and be injured. Never leave children alone in the vehicle.

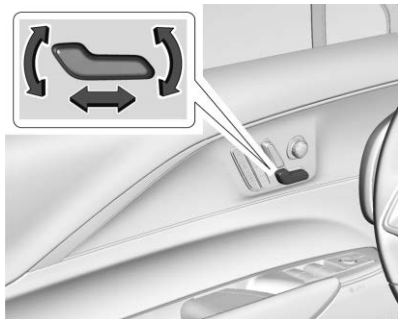

To adjust the seat:

- Move the seat forward or rearward by sliding the control forward or rearward.
- Raise or lower the front part of the seat cushion by moving the front of the control up or down.
- Raise or lower the entire seat by moving the rear of the control up or down.

To adjust the seatback, see *Reclining Seat Backrests* ⇨ 36.

To adjust the lumbar support, see *Lumbar Adjustment* ⇨ 37.

Reclining Seat Backrests

Warning

Sitting in a reclined position when the vehicle is in motion can be dangerous. Even when fastened, the seat belts cannot do their job.

The shoulder belt will not be against your body. Instead, it will be in front of you. In a crash, you could go into it, receiving neck or other injuries.

The lap belt could go up over your abdomen. The belt forces would be there, not at your pelvic bones. This could cause serious internal injuries.

For proper protection when the vehicle is in motion, have the seatback upright. So sit well back in the seat and wear the seat belt properly.



Do not have a backrest reclined if the vehicle is moving.

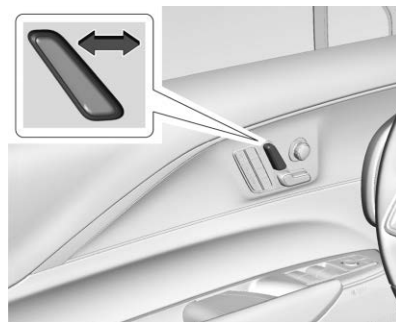

- Move the control back to recline.
- Move the control forward to raise.

Lumbar Adjustment

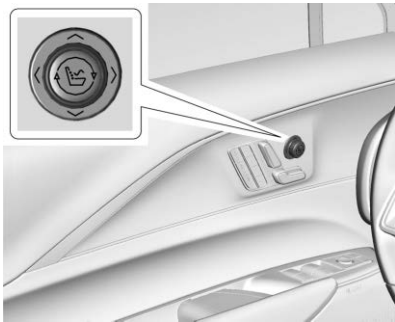

- Press and hold the front or rear of the control to increase or decrease lumbar support.
- If equipped, press and hold the top or bottom of the control to raise or lower lumbar support.

Up-level Seat Adjustment



To adjust lumbar support, if equipped:

- Rotate the centre of the control to scroll to lumbar support on the infotainment display.
- Press $>$ or $<$ to adjust lumbar forward or rearward.
- Press \wedge or \vee to adjust lumbar up or down.

Bolster Support

To adjust bolster support, if equipped:

- Rotate the centre of the control to scroll to bolster support on the infotainment display.

- Press $>$ or $<$ to adjust the bolster outward or inward.

Massage



If equipped, the vehicle must be on to use the massage feature.

To activate and adjust massage:

- Rotate the centre of the control to scroll to massage on the infotainment display.
- Press \wedge or \vee to adjust massage type.
- $>$ or $<$ to adjust the intensity.
- To turn massage off or to activate massage at last massage type and intensity settings, press the centre of the control.

The massage feature will turn off after approximately 20 minutes. Press the centre of the control to restart the massage feature.

Memory Seats

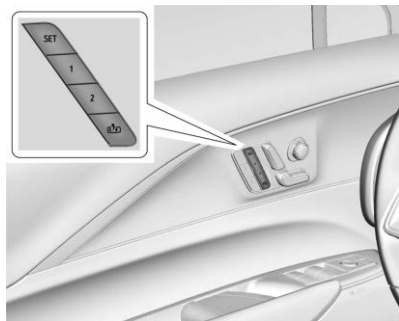

Overview

If equipped, the memory seat feature allows drivers to save their unique driving positions and a shared exit position. See “Saving Seating Positions” later in this section. The saved positions can be recalled manually by all drivers. See “Manually Recalling Seating Positions” later in this section. Drivers with remote key 1 and 2 can also recall them automatically. See “Auto Seat Entry Memory Recall” or “Auto Seat Exit Memory Recall”

later in this section. To enable automatic recalls, turn on Seat Entry Memory and/or Seat Exit Memory. See “Enabling Automatic Recalls” later in this section. The memory recalls may be cancelled at any time during the recall. See “Cancel Memory Seating Recalls” later in this section.

Identifying Driver Number

The vehicle identifies the current driver by their remote key number 1–8. The current remote key number may be identified by Driver Information Center (DIC) welcome message, “You are driver x for memory recalls.” This message is displayed the first few times the vehicle is turned on when a different remote key is used. For Seat Entry Memory to work properly, save positions to the 1 or 2 memory button matching the driver number of this welcome message. To aid in identifying remote key IDs, it is recommended to only carry one remote key when entering the vehicle. Perform the following if the welcome message is not displayed:

1. Move all remote keys away from the vehicle.
2. Turn the vehicle on with another remote key. A DIC welcome message should display indicating the driver number of

the other remote key. Turn the vehicle off and remove the other remote key from the vehicle.

3. Turn the vehicle on with the initial remote key. The DIC welcome message should display the driver number of the initial remote key.

Saving Seating Positions

Read these instructions completely before saving memory positions.



To save preferred driving positions to 1 and 2:

1. Turn the vehicle on. A DIC welcome message may indicate the driver number of the current remote key. See “Identifying Driver Number” previously in this section.
2. Adjust all available memory features to the desired driving position.
3. Press and release SET; a chime will sound.
4. Immediately upon releasing SET, press and hold memory button 1 or 2 matching the current driver's remote key number until two chimes sound. If too much time passes between releasing SET and pressing 1 or 2, the two chimes will not

sound indicating memory position were not saved. Repeat Steps 3 and 4 to try again.

- Repeat Steps 1–4 for the other remote key 1 or 2 using the other 1 or 2 memory button.

If you are the only driver, it is recommended to save the preferred driving position to both 1 and 2.

To save the common exit seating position to  that is used by all drivers for Manually Recalling Seating Positions and Auto Seat Exit Memory Recall features, repeat Steps 1–4 using , the exit button.

Manually Recalling Seating Positions

Press and hold 1, 2, or  button until the recall is complete, to recall the positions previously saved to that button.

Manual Memory recall movement for 1, 2 or  buttons may be initiated and will complete to the saved memory position if the vehicle is in or out of P (Park).

Enabling Automatic Recalls

- Seat Entry Memory moves the driver seat to the selected 1 or 2 position when the vehicle is started. Select Settings > Vehicle

> Seating Position > Seat Entry Memory > ON or OFF. See “Auto Seat Entry Memory Recall” later in this section.

- Seat Exit Memory moves the driver seat to the preferred exit position of the  button when the vehicle is turned off and the door is opened. Select Settings > Vehicle > Seating Position > Seat Exit Memory > ON or OFF. See “Auto Seat Exit Memory Recall” later in this section.

Auto Seat Entry Memory Recall

Seat Entry Memory will automatically begin movement to the seating positions of the 1 or 2 button corresponding to the driver's remote key number 1 or 2 detected by the vehicle when:

- The vehicle is turned ON.
- Seating positions have been previously saved to the same 1 or 2 button. See “Saving Seating Positions” previously in this section.
- Seat Entry Memory is enabled. See “Enabling Automatic Recalls” previously in this section.
- The vehicle is in P (Park).

Seat Entry Memory Recall will continue if the vehicle is changed out of P (Park) prior to reaching the saved memory position.

If the saved memory seat position does not automatically recall, verify the recall is enabled. See “Enabling Automatic Recalls” previously in this section.

If the memory seat recalls to the wrong position, the driver's remote key number 1 or 2 may not match the memory button number positions they were saved to. Try the other remote key or try saving the positions to the other 1 or 2 memory button. See “Saving Seating Positions” previously in this section.

Automatic Seat Entry Memory recalls are only available for driver's remote key numbers 1 and 2. Remote keys 3–8 will not provide Seat Entry Memory recalls.

Auto Seat Exit Memory Recall

Seat Exit Memory will begin movement to the seating position of the  button when:

- The vehicle is turned off and the driver door is open or opened within a short time.
- A seating position has been previously been saved to the  memory button. See “Saving Seating Positions” previously in this section.



- Seat Exit Memory is enabled. See “Enabling Automatic Recalls” previously in this section.
- The vehicle is in P (Park).

Seat Exit Memory recall will continue if the vehicle is changed out of P (Park) prior to reaching the saved memory position.

Seat Exit Memory is not linked to the driver's remote key. The seating position saved to  is used for all drivers.

Cancel Memory Seating Recalls

- During any memory recall:
Press a power seat control
Press SET memory button
- During Manual memory recall:
Release 1, 2, or  memory button
- During Auto Seat Entry Memory Recall:
Turn the vehicle off

Press SET, 1, 2, or  memory buttons
- During Auto Seat Exit Memory Recall:
Press SET, 1, 2, or  memory buttons

Obstructions

If something has blocked the seat while recalling a memory position, the recall may stop. Remove the obstruction and try the

recall again. If the memory position still does not recall, see your Cadillac Brand Ambassador.

Heated and Ventilated Front Seats



Warning



If temperature change or pain to the skin cannot be felt, the seat heater may cause burns. To reduce the risk of burns, use care when using the seat heater, especially for long periods of time. Do not place anything on the seat that insulates against heat, such as a blanket, cushion, cover, or similar item. This may cause the seat heater to overheat. An overheated seat heater may cause a burn or may damage the seat.





Heated and Ventilated Seat Buttons Shown, Heated Seat Buttons Similar

If equipped, the buttons are located on the door panel. To operate, the vehicle must be on.

Press  or  to heat the driver or passenger backrest and cushion.

Press  or  to heat the driver or passenger backrest.

Press  or , if available, to ventilate the driver or passenger seat. A ventilated seat has a fan that pulls or pushes air through the seat. The air is not cooled.

When this feature is off, the heated and ventilated seat symbols on the buttons are white. When a heated seat is on, the symbol is red. When a ventilated seat is on, the symbol is blue.

Press the button once for the highest setting. With each press of the button, the seat will change to the next lower setting, and then to the off setting. The indicator lights next to the buttons indicate three for the highest setting and one for the lowest. If the heated seats are on high, the level may automatically be lowered after approximately 30 minutes.

The passenger seat may take longer to heat up.

Auto Heated and Ventilating Seats

When the vehicle is on, this feature will automatically activate the heated or ventilated seats at the level required by the vehicle's interior temperature.

The active high, medium, low, or off heated or ventilated seat level will be indicated by the manual heated or ventilated seat buttons on the door panel. Use the manual heated or ventilated seat buttons on the door panel to turn auto heated or ventilated seats off. If the passenger seat is

unoccupied, the auto heated or ventilated seats feature will not activate that seat. To enable or disable auto heated or ventilated seats, select Settings > Vehicle > Climate and Air Quality > Auto Cooled or Auto Heated Seats > ON or OFF.

Remote Start Heated and Ventilating Seats

During a remote start, the heated or ventilated seats, if equipped, can be turned on automatically. When it is cold outside, the heated seats turn on, and when it is hot outside the ventilated seats turn on. If the auto heated or ventilated seats feature, if equipped, is not turned on, the heated or ventilated seats may be cancelled when the vehicle is turned on. If necessary, press the heated or ventilated seat button to use the heated or ventilated seats after the vehicle is started.

The heated or ventilated seat indicator lights may turn on during a remote start.

The temperature performance of an unoccupied seat may be reduced. This is normal.

To enable or disable remote start heated or ventilated seats, select Settings > Vehicle > Remote Lock, Unlock, and Start > Remote

Start Auto Heat Seats or Remote Start Auto Cool Seats > ON or OFF. See *Remote Start* ⇨ 12.

Rear Seats

Rear Seat Reminder

The message REAR SEAT REMINDER LOOK IN REAR SEAT displays under certain conditions indicating there may be an item or passenger in the rear seat. Check before exiting the vehicle.

This feature will activate when a second row door is opened while the vehicle is on, or up to 10 minutes before the vehicle is turned on. There will be an alert when the vehicle is turned off. The alert does not directly detect objects in the rear seat; instead, under certain conditions, it detects when a rear door is opened and closed, indicating that there may be something in the rear seat.

The feature is active only once each time the vehicle is turned on and off, and will require reactivation by opening and closing the second row doors. There may be an alert even when there is nothing in the rear

42 Seats and Restraints

seat; for example, if a child entered the vehicle through the rear door and left the vehicle without the vehicle being turned off.

The feature can be turned on or off. Select Settings > Vehicle > Rear Seat Reminder > ON or OFF.

Reclining the Backrest

To recline the seat backrest:

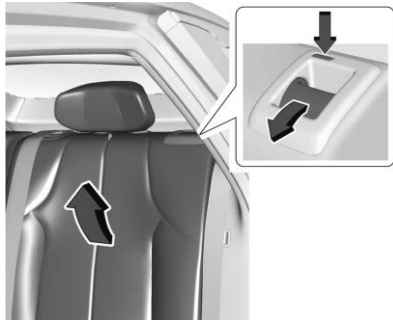

1. Pull the reclining backrest handle.
A tab near the backrest handle raises when the backrest is unlocked.
2. Move the backrest to the desired position, and then release the handle to lock the backrest in place.

3. Push and pull on the backrest to make sure it is locked.

Folding the Seat Backrest

Either side of the seatback can be folded for more cargo space. Fold a seatback only when the vehicle is not moving.

Warning

Folding a rear seat with the seat belts still fastened may cause damage to the seat or the seat belts. Always unfasten the seat belts and return them to their normal stowed position before folding a rear seat.

To fold the seatback:



1. Stow the seat belt latch plate in the storage slot.

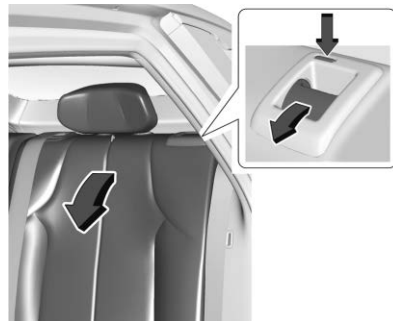

2. Pull the handle on top of the seatback to unlock it.
3. Fold the backrest forward.

Repeat the steps to fold the other backrest, if desired.

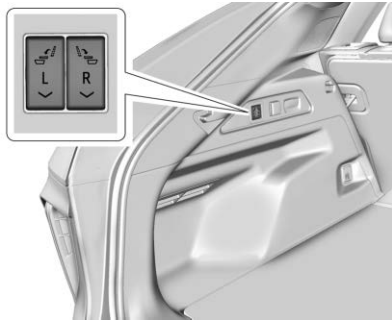

If equipped, the rear backrests can also be folded forward by pressing and holding the switches located in the rear cargo area.

The left switch folds the left backrest, and the right switch folds the right backrest.

Raising the Seat Backrest

Warning

If either seatback is not locked, it could move forward in a sudden stop or crash. That could cause injury to the person sitting there. Always push and pull on the seatbacks to be sure they are locked.

Warning

A seat belt that is improperly routed, not properly attached, or twisted will not provide the protection needed in a crash. The person wearing the belt could be seriously injured. After raising the rear backrest, always check to be sure that the seat belts are properly routed and attached, and are not twisted.

To raise a seatback:



1. Ensure the seat belt latch plate is in the stowage slot.
2. Lift the seatback up and push it rearward to lock it in place.
A tab near the backrest handle retracts when the backrest is locked in place.
3. Push and pull the top of the backrest to be sure it is locked into position.
4. Repeat the steps to raise the other seatback, if necessary.

When the seat is not in use, it should be kept in the upright, locked position.



Heated Rear Seats

Warning

If temperature change or pain to the skin cannot be felt, the seat heater may cause burns. See the Warning under *Heated and Ventilated Front Seats* ⇨ 40.



If equipped, the buttons are on the rear of the centre console.

With the vehicle on, press  or  to heat the left or right outboard seat cushion and backrest. An indicator on the rear climate control display appears when this feature is on.

Press the button once for the highest setting. With each press of the button, the seat will change to the next lower setting, and then to the off setting. The indicator lights next to the buttons indicate three for the highest setting and one for the lowest.

If the heated seats are on high for approximately 30 minutes, their level may automatically be lowered.

Remote Start Heated Seats

If equipped, the heated seats will turn on automatically during a remote start if it is cold outside. The heated seat indicators may come on during this operation. The heated seats may cancel when the vehicle is turned on. These features can be manually selected with the heated seat buttons after the vehicle is turned on.

The temperature performance of an unoccupied seat may be reduced. This is normal.

To enable or disable remote start heated seats, select Settings > Vehicle > Remote Lock, Unlock, and Start > Remote Start Auto Heat Seats > ON or OFF. See *Remote Start* ⇨ 12.

Seat Belts

This section describes how to use seat belts properly, and some things not to do.

Warning

Do not let anyone travel where a seat belt cannot be worn properly. In a crash, if you or your passenger(s) are not wearing seat belts, injuries can be much worse than if you are wearing seat belts. You can be seriously injured or killed by hitting things inside the vehicle harder or by being ejected from the vehicle. In addition, anyone who is not buckled up can strike other passengers in the vehicle.

It is extremely dangerous to ride in a cargo area, inside or outside of a vehicle. In a collision, passengers riding in these areas are more likely to be seriously injured or killed. Do not allow passengers to travel in any area of the vehicle that is not equipped with seats and seat belts.

Always wear a seat belt, and check that all passenger(s) are restrained properly too.

This vehicle has indicators as a reminder to fasten the seat belts. See *Seat Belt Reminders* ⇨ 90.

Why Seat Belts Work

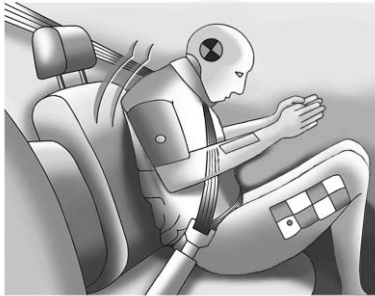

When riding in a vehicle, you travel as fast as the vehicle does. If the vehicle stops suddenly, you keep going until something stops you. It could be the windscreen, the instrument panel, or the seat belts!

When you wear a seat belt, you and the vehicle slow down together. There is more time to stop because you stop over a longer distance and, when worn properly, your strongest bones take the force of the seat belts. That is why wearing seat belts makes such good sense.

Questions and Answers About Seat Belts

Q: Will I be trapped in the vehicle after a crash if I am wearing a seat belt?

A: You *could* be — whether you are wearing a seat belt or not. Your chances of being conscious during and after a crash, so you *can* unbuckle and get out, are *much* greater if you are belted.

Q: If my vehicle has airbags, why should I have to wear seat belts?

A: Airbags are supplemental systems only. They work *with* the seat belts — not instead of them. Whether or not an airbag is provided, all occupants still have to buckle up to get the most protection.

Also the law in nearly every region requires seat belts to be worn.

How to Wear Seat Belts Properly

Follow these rules for everyone's protection.

There are additional things to know about seat belts and children, including smaller children and infants. If a child will be riding in the vehicle, see *Older Children* ⇨ 59 or

Child Restraint Systems ⇨ 61. Review and follow the rules for children in addition to the following rules.

It is very important for all occupants to buckle up. Statistics show that unbelted people are hurt more often in crashes than those who are wearing seat belts.

There are important things to know about wearing a seat belt properly.

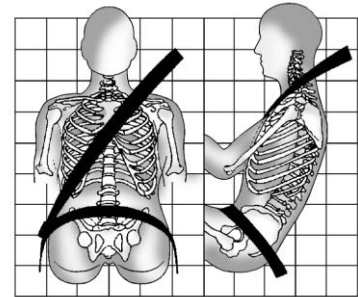

- Sit up straight and always keep your feet on the floor in front of you (if possible).
- Always use the correct buckle for your seating position.
- Wear the lap part of the belt low and snug on the hips, just touching the thighs. In a crash, this applies force to the

strong pelvic bones and you would be less likely to slide under the lap belt. If you slid under it, the belt would apply force on your abdomen. This could cause serious or even fatal injuries.

- Wear the shoulder belt over the shoulder and across the chest. These parts of the body are best able to take belt restraining forces. The shoulder belt locks if there is a sudden stop or crash.

Warning

You can be seriously injured, or even killed, by not wearing your seat belt properly.

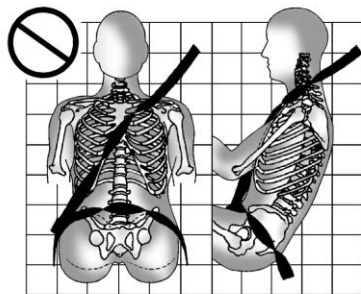
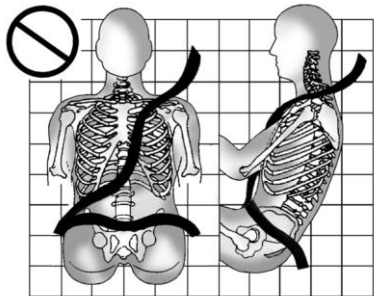

Never allow the lap or shoulder belt to become loose or twisted.

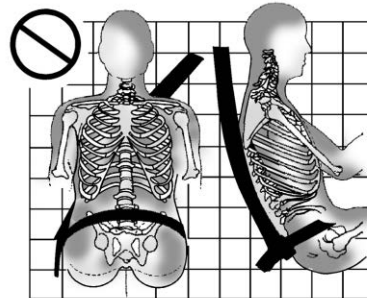
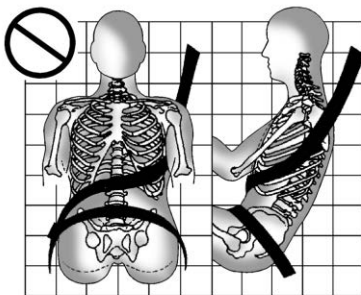

Never wear the shoulder belt under both arms or behind your back.

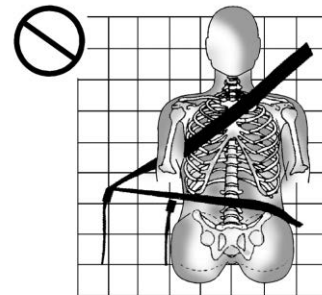

Always use the correct buckle for your seating position.

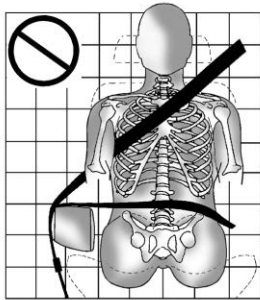

Never route the lap or shoulder belt over an armrest.

Warning

The seat belt can be pinched if it is routed under plastic trim on the seat, such as trim around the rear backrest folding handle or side airbag. In a crash, pinched seat belts might not be able to provide adequate protection. Never allow seat belts to be routed under plastic trim pieces.

Lap-Shoulder Belt

All seating positions in the vehicle have a lap-shoulder belt.

The following instructions explain how to wear a lap-shoulder belt properly.

1. Adjust the seat, if the seat is adjustable, so you can sit up straight. To see how, see "Seats" in the Index.

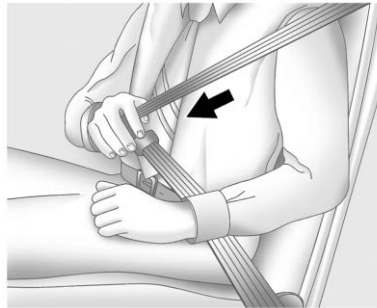

2. Pick up the latch plate and pull the belt across you. Do not let it get twisted.

The lap-shoulder belt may lock if you pull the belt across you very quickly. If this happens, let the belt go back slightly to unlock it. Then pull the belt across you more slowly.

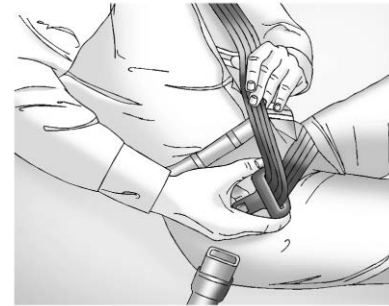

If the webbing locks in the catch plate before it reaches the buckle, tilt the catch plate flat to unlock.

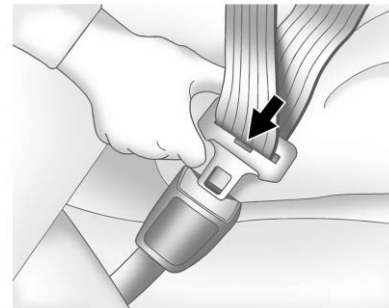

3. Push the latch plate into the buckle until it clicks.
Pull up on the latch plate to make sure it is secure.
Position the release pushbutton on the buckle so that the seat belt could be quickly unfastened if necessary.
4. If equipped with a shoulder belt height adjuster, move it to the height that is right for you. See “Shoulder Belt Height Adjuster” later in this section for instructions on use and important safety information.

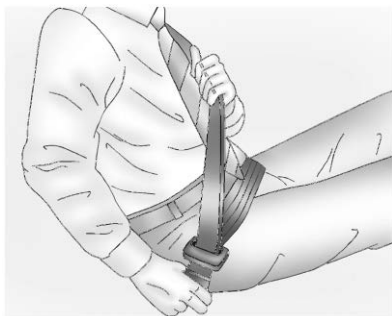

5. To make the lap part tight, pull up on the shoulder belt.

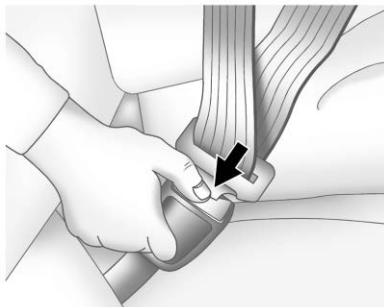

To unlatch the belt, push the release pushbutton on the buckle. The belt should return to its stowed position.

Always stow the seat belt slowly. If the seat belt webbing returns quickly to the stowed position, the retractor may lock and cannot be pulled out. If this happens, pull the seat belt straight out firmly to unlock the webbing, and then release it. If the webbing is still locked in the retractor, see your Cadillac Brand Ambassador.

Before a door is closed, be sure the seat belt is out of the way. If a door is slammed against a seat belt, damage can occur to both the seat belt and the vehicle.

Shoulder Belt Height Adjuster

The vehicle has a shoulder belt height adjuster for the driver and front outboard passenger seating positions.

Adjust the height so the shoulder portion of the belt is on the shoulder and not falling off it. The belt should be close to, but not contacting, the neck. Improper shoulder belt height adjustment could reduce the effectiveness of the seat belt in a crash. See *How to Wear Seat Belts Properly* ⇨ 45.

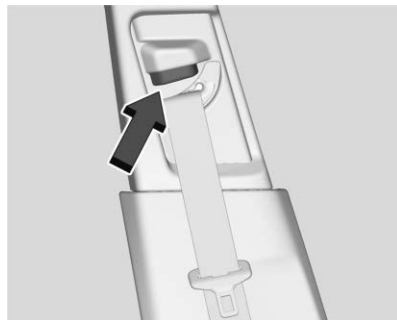

Press the release button and move the height adjuster to the desired position. The adjuster can be moved up by pushing the slide/trim up. After the adjuster is set to the

desired position, try to move it down without pressing the release button to make sure it has locked into position.

Seat Belt Pretensioners

This vehicle has seat belt pretensioners for front row and second row outboard occupants. Although the seat belt pretensioners cannot be seen, they are part of the seat belt assembly. They can help tighten the seat belts during the early stages of a moderate to severe frontal, near frontal, or rear crash if the threshold conditions for pretensioner activation are met. Seat belt pretensioners can also help tighten the seat belts in a side crash or a roll-over event.

Pretensioners work only once. If the pretensioners activate in a collision, the pretensioners and probably other parts of the vehicle seat belt system will need to be replaced. See *Replacing Seat Belt System Parts after a Crash* ⇨ 50.

Do not sit on the outboard seat belt while entering or exiting the vehicle or at any time while sitting in the seat. Sitting on the seat belt can damage the webbing and hardware.

Seat Belt Use During Pregnancy

Seat belts work for everyone, including pregnant women. Like all occupants, they are more likely to be seriously injured if they do not wear seat belts.



A pregnant woman should wear a lap-shoulder belt, and the lap portion should be worn as low as possible, below the rounding, throughout the pregnancy.

The best way to protect the foetus is to protect the mother. When a seat belt is worn properly, it is less likely that the foetus will be hurt in a crash. For pregnant women, as for anyone, the key to making seat belts effective is to wear them properly.

Safety System Check

Periodically check the seat belt reminder, seat belts, buckles, latch plates, retractors, shoulder belt height adjusters (if equipped) and seat belt anchorages to make sure they are all in working order. Look for any other loose or damaged seat belt system parts that might keep a seat belt system from performing properly. See your Cadillac Service Centre to have it repaired. Torn, frayed or twisted seat belts may not protect you in a crash. Torn or frayed seat belts can rip apart under impact forces. If a belt is torn or frayed, have it replaced immediately. If a belt is twisted, it may be possible to untwist it by reversing the latch plate on the webbing. If the twist cannot be corrected, ask your Cadillac Service Centre to fix it.

Make sure the seat belt reminder light is working. See *Seat Belt Reminders* ⇨ 90.

Keep seat belts clean and dry. See *Seat Belt Care* ⇨ 49.

Seat Belt Care

Keep belts clean and dry.

Seat belts should be properly cared for and maintained.

Seat belt hardware should be kept dry and free of dust or debris. As necessary, exterior hard surfaces and seat belt webbing may be lightly cleaned with mild soap and water. Ensure there is not excessive dust or debris in the mechanism. If dust or debris exists in the system please see the Cadillac Service Centre. Parts may need to be replaced to ensure proper functionality of the system.

Warning

Do not bleach or dye seat belt webbing. It may severely weaken the webbing. In a crash, they might not be able to provide adequate protection. Clean and rinse seat belt webbing only with mild soap and lukewarm water. Allow the webbing to dry.

Replacing Seat Belt System Parts after a Crash

Warning

A crash can damage the seat belt system in the vehicle. A damaged seat belt system may not properly protect the person using it, resulting in serious injury
(Continued)

Warning (Continued)

or even death in a crash. To help make sure the seat belt systems are working properly after a crash, have them inspected and any necessary replacements made as soon as possible.

After a minor crash, replacement of seat belts may not be necessary. But the seat belt assemblies that were used during any crash may have been stressed or damaged. See your Cadillac Service Centre to have the seat belt assemblies inspected or replaced.

New parts and repairs may be necessary even if the seat belt system was not being used at the time of the crash.

Have the seat belt pretensioners checked if the vehicle has been in a crash, or if the airbag readiness light stays on after you start the vehicle or while you are driving. See *Airbag Readiness Light* ⇨ 91.

Airbag System

The vehicle has the following airbags:

- A frontal airbag for the driver
- A frontal airbag for the front outboard passenger

- A seat-mounted side impact airbag for the driver
- A seat-mounted side impact airbag for the front outboard passenger
- A roof-rail airbag for the driver and the passenger seated directly behind the driver
- A roof-rail airbag for the front outboard passenger and the passenger seated directly behind the front outboard passenger

All vehicle airbags have the word AIRBAG on the trim or on a label near the deployment opening.

For frontal airbags, the word AIRBAG is on the centre of the steering wheel for the driver and on the instrument panel for the front outboard passenger.

For seat-mounted side impact airbags, the word AIRBAG is on the side of the backrest or side of the seat closest to the door.

For roof-rail airbags, the word AIRBAG is on the ceiling or trim.

Airbags are designed to supplement the protection provided by seat belts. Even though today's airbags are also designed to

help reduce the risk of injury from the force of an inflating bag, all airbags must inflate very quickly to do their job.

Here are the most important things to know about the airbag system:

Warning

You can be severely injured or killed in a crash if you are not wearing your seat belt, even with airbags. Airbags are designed to work with seat belts, not replace them. Also, airbags are not designed to inflate in every crash. In some crashes seat belts are the only restraint. See *When Should an Airbag Inflate?* ⇨ 53.

Wearing your seat belt during a crash helps reduce your chance of hitting things inside the vehicle or being ejected from it. Airbags are “supplemental restraints” to the seat belts. Everyone in the vehicle should wear a seat belt properly, whether or not there is an airbag for that person.

Warning

Because airbags inflate with great force and faster than the blink of an eye, anyone who is up against, or very close to, an airbag when it inflates can be seriously injured or killed. Do not sit unnecessarily close to any airbag, as you would be if sitting on the edge of the seat or leaning forward. Seat belts help keep you in position before and during a crash. Always wear a seat belt, even with airbags. The driver should sit as far back as possible while still maintaining control of the vehicle. The seat belts and the front outboard passenger airbags are most effective when you are sitting well back and upright in the seat with both feet on the floor.

Occupants should not lean on or sleep against the door or side windows in seating positions with seat-mounted side impact airbags and/or roof-rail airbags.

Warning

Children who are up against, or very close to, any airbag when it inflates can be seriously injured or killed. Always secure children properly in the vehicle. To read how, see *Older Children* ⇨ 59 or *Child Restraint Systems* ⇨ 61.



There is an airbag readiness light on the instrument cluster, which shows the airbag symbol.

The system checks the airbag electrical system for malfunctions. The light tells you if there is an electrical problem. See *Airbag Readiness Light* ⇨ 91.

Where Are the Airbags?

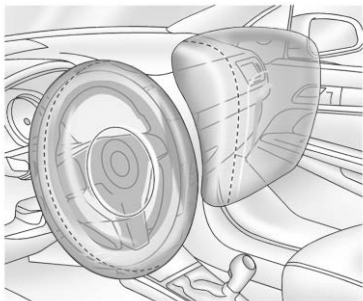

The driver frontal airbag is in the centre of the steering wheel.

The front outboard passenger frontal airbag is in the passenger side instrument panel.



Driver Side Shown, Passenger Side Similar

The driver and front outboard passenger seat-mounted side impact airbags are in the sides of the seatbacks closest to the door.



Driver Side Shown, Passenger Side Similar

The roof-rail airbags for the driver, front outboard passenger, and second row outboard passengers are in the ceiling above the side windows.

Warning

If something is between an occupant and an airbag, the airbag might not inflate properly or it might force the object into that person causing severe injury or even death. The path of an inflating airbag must be kept clear. Do not put anything between an occupant and an airbag, and

(Continued)

Warning (Continued)

do not attach or put anything on the steering wheel hub or on or near any other airbag covering.

Do not use seat accessories that block the inflation path of a seat-mounted side impact airbag.

Never secure anything to the roof of a vehicle with roof-rail airbags by routing a rope or tie-down through any door or window opening. If you do, the path of an inflating roof-rail airbag will be blocked.

When Should an Airbag Inflate?

This vehicle is equipped with airbags. See *Airbag System* ⇨ 50. Airbags are designed to inflate if the impact exceeds the specific airbag system's deployment threshold. Deployment thresholds are used to predict how severe a crash is likely to be in time for the airbags to inflate and help restrain the occupants. The vehicle has electronic sensors that help the airbag system determine the severity of the impact. Deployment thresholds can vary with specific vehicle design.

Frontal airbags are designed to inflate in moderate to severe frontal crashes to help reduce the potential for severe injuries, mainly to the driver's or front outboard passenger's head and chest.

Whether the frontal airbags will or should inflate is not based primarily on how fast the vehicle is travelling. It depends on what is hit, the direction of the impact, and how quickly the vehicle slows down.

Frontal airbags may inflate at different crash speeds depending on whether the vehicle hits an object straight on or at an angle, and whether the object is fixed or moving, rigid or deformable, narrow or wide.

Frontal airbags are not intended to inflate during vehicle rollovers, in rear impacts, or in many side impacts.

In addition, the vehicle has advanced technology frontal airbags. Advanced technology frontal airbags adjust the restraint according to either crash severity or occupant interaction.

Seat-mounted side impact airbags are designed to inflate in moderate to severe side crashes depending on the location of the impact. These airbags may also inflate in some moderate to severe frontal impacts.

Seat-mounted side impact airbags are not designed to inflate in rollovers or rear impacts. A seat-mounted side impact airbag is designed to inflate on the side of the vehicle that is struck.

Roof-rail airbags are designed to inflate in moderate to severe side crashes depending on the location of the impact. In addition, these roof-rail airbags may inflate during a rollover or in a severe frontal impact. Roof-rail airbags are not designed to inflate in rear impacts. Both roof-rail airbags may inflate when either side of the vehicle is struck or if the sensing system predicts that the vehicle is about to roll over on its side, or in a severe frontal impact.

In any particular crash, no one can say whether an airbag should have inflated simply because of the vehicle damage or repair costs.

What Makes an Airbag Inflate?

In a deployment event, the sensing system sends an electrical signal triggering a release of gas from the inflator. Gas from the inflator fills the airbag causing the bag to break out of the cover. The inflator, the airbag, and related hardware are all part of the airbag module.

For airbag locations, see *Where Are the Airbags?* ⇨ 52.

How Does an Airbag Restrain?

In moderate to severe frontal collisions, even belted occupants can contact the steering wheel or the instrument panel. In moderate to severe side collisions, even belted occupants can contact the inside of the vehicle.

Airbags supplement the protection provided by seat belts by distributing the force of the impact more evenly over the occupant's body.

Rollover capable roof-rail airbags are designed to help contain the head and chest of occupants in the outboard seating positions in the first and second rows. The rollover capable roof-rail airbags are designed to help reduce the risk of full or partial ejection in rollover events, although no system can prevent all such ejections.

But airbags would not help in many types of collisions, primarily because the occupant's motion is not toward those airbags. See *When Should an Airbag Inflate?* ⇨ 53.

Airbags should never be regarded as anything more than a supplement to seat belts.

What Will You See after an Airbag Inflates?

After frontal and seat-mounted side impact airbags inflate, they quickly deflate, so quickly that some people may not even realise the airbags have inflated. Roof-rail airbags may still be at least partially inflated for some time after deployment. Some components of the airbag module may be hot for several minutes. For location of the airbags, see *Where Are the Airbags?* ⇨ 52.

The parts of the airbag that come into contact with you may be warm, but not too hot to touch. There may be some smoke and dust coming from the vents in the deflated airbags. Airbag inflation does not prevent people from leaving the vehicle.

Warning

When an airbag inflates, there may be dust in the air. This dust could cause breathing problems for people with a

(Continued)

Warning (Continued)

history of asthma or other breathing trouble. To avoid this, everyone should leave the vehicle as soon as it is safe to do so. If you have breathing problems but cannot get out of the vehicle after an airbag inflates, then get fresh air by opening a window or a door. If you experience breathing problems following an airbag deployment, you should seek medical attention.

The vehicle has a feature that may automatically unlock the doors, turn on the interior lamps and hazard warning flashers after the airbags inflate. The feature may also activate, without airbag inflation, after an event that exceeds a predetermined threshold. After turning the vehicle off and then on again, the doors can be locked, the interior lamps can be turned off, and the hazard warning lights can be turned off using the controls for those features. If any of these systems are damaged in the crash they may not operate as normal.

⚠ Warning

A collision severe enough to inflate the airbags may have also damaged important functions in the vehicle, such as the brake and steering systems, etc. Even if the vehicle appears to be drivable after a moderate collision, there may be concealed damage that could make it difficult to safely operate the vehicle.

Use caution if attempting to restart the vehicle after a crash has occurred.

Plug-in vehicles have a high voltage battery and a standard 12-volt battery.

If an airbag inflates or the vehicle has been in a crash, the sensing system may shut down the high voltage system. When this occurs, the high voltage battery is disconnected and the vehicle will not start. Before the vehicle can be operated again, it must be serviced at your Cadillac Service Centre.

In many crashes severe enough to inflate the airbag, windscreens are broken by vehicle deformation. Additional windscreen breakage may also occur from the front outboard passenger airbag.

- Airbags are designed to inflate only once. After an airbag inflates, you will need some new parts for the airbag system. If you do not get them, the airbag system will not be there to help protect you in another crash. A new system will include airbag modules and possibly other parts. The service manual for the vehicle covers the need to replace other parts.
- The vehicle has a crash sensing and diagnostic module which records information after a crash. See *Vehicle Data Recording and Privacy* ⇨ 303.
- Let only qualified technicians work on the airbag system. Improper service can mean that an airbag system will not work properly. See your Cadillac Service Centre for service.

Airbag On-Off Switch**Airbag Deactivation**

The front passenger frontal airbag must be deactivated for a rear-facing child restraint on the front passenger seat and for certain forward-facing child restraints according to the instructions in the tables under *Where to Put the Restraint* ⇨ 65. The other airbag systems, the seat belt pretensioners, and all driver airbag systems will remain active.



If the instrument panel has the switch pictured in the illustration, the vehicle has an airbag on-off switch that you can use to manually turn on or off the front outboard passenger airbag.

No other airbag is affected by the on-off switch.

⚠ Warning

Deactivate the front passenger airbag only in combination with the use of a child restraint, subject to the instructions and restrictions in the tables listed in this manual. See *Where to Put the Restraint* ⇨ 65.

(Continued)

Warning (Continued)

Otherwise, there is a risk of fatal injury for a person occupying a seat with a deactivated front passenger airbag.

This switch should only be turned to the OFF position if the person in the front outboard passenger position belongs to a category indicated in this section:

Infant. An infant (less than 1 year old) must travel in the front seat because:

- My vehicle has no rear seat;
- My vehicle has a rear seat too small to accommodate a rear-facing infant seat; or
- The infant has a medical condition which, according to the infant's physician, makes it necessary for the infant to ride in the front seat so that the driver can constantly monitor the child's condition.

Child age 1 to 12. A child age 1 to 12 must travel in the front seat because:

- My vehicle has no rear seat;
- Although children ages 1 to 12 ride in the rear seat(s) whenever possible, children ages 1 to 12 sometimes must travel in the front because no space is available in the rear seat(s) of my vehicle; or

- The child has a medical condition which, according to the child's physician, makes it necessary for the child to travel in the front seat so that the driver can constantly monitor the child's condition.

Medical Condition. A passenger has a medical condition which, according to his or her physician:

- Causes the passenger airbag to pose a special risk for the passenger; and
- Makes the potential harm from the passenger airbag in a crash greater than the potential harm from turning off the airbag and allowing the passenger, even if belted, to hit the instrument panel or windshield in a crash.

Warning

If the front outboard passenger frontal airbag is turned off for a person who does not belong to a category indicated in this section, that person will not have the extra protection of an airbag. In a crash, the airbag will not be able to inflate and help protect the person sitting there. Do not turn off the front outboard
(Continued)

Warning (Continued)

passenger frontal airbag unless the person sitting there belongs to a category indicated in this section.

The front passenger airbag can be deactivated via a key-operated switch on the passenger side of the instrument panel.

Insert a key into the switch, push in, and move the key to the desired position:



The front passenger airbag is deactivated and will not inflate in the event of a collision.

The airbag off light will come on and stay on to let you know the front outboard passenger airbag is turned off. See *Airbag On-Off Light* ⇨ 92. The front outboard passenger airbag will remain turned off until you turn it back on again.

Warning

If the airbag readiness light ever comes on and stays on, it means that something may be wrong with the airbag system. For example, the front outboard passenger frontal airbag could inflate even though the airbag on-off switch is turned off.

To help avoid injury to yourself or others, have the vehicle serviced right away. See *Airbag Readiness Light* ⇨ 91 for more information, including important safety information.

To turn the front outboard passenger airbag on again, insert the ignition key into the airbag on-off switch, push in, and move the switch to the ON position.



The front outboard passenger frontal airbag is now enabled, and may inflate. See *Airbag On-Off Light* ⇨ 92.

The front outboard passenger frontal airbag will be enabled or disabled according to the setting until you change it.

Warning

Deactivate the front passenger airbag only in combination with the use of a child restraint, subject to the instructions and restrictions in the tables listed in this manual. See *Where to Put the Restraint* ⇨ 65.

(Continued)

Warning (Continued)

Otherwise, there is a risk of fatal injury for a person occupying a seat with a deactivated front passenger airbag.

Servicing the Airbag-Equipped Vehicle

Airbags affect how the vehicle should be serviced. There are parts of the airbag system in several places around the vehicle. Your Cadillac Service Centre and the service manual have information about servicing the vehicle and the airbag system.

Warning

For up to 10 seconds after the vehicle is turned off and the battery is disconnected, an airbag can still inflate during improper service. You can be injured if you are close to an airbag when it inflates. Avoid yellow connectors. They are probably part of the airbag system. Be sure to follow proper service procedures, and make sure the person performing work for you is qualified to do so.

 **Warning**

Safety procedures must be followed at all times when disposing of the vehicle or vehicle parts. Disposal should be performed only by an authorised service centre, to help protect the environment and your health.

Adding Equipment to the Airbag-Equipped Vehicle

Adding accessories that change the vehicle's frame, bumper system, height, front end, or side sheet metal may keep the airbag system from working properly.

The operation of the airbag system can also be affected by changing, including improperly repairing or replacing, any parts of the following:

- Airbag system, including airbag modules, front or side impact sensors, sensing and diagnostic module, or airbag wiring
- Front seats, including stitching, seams or zip fasteners
- Seat belts
- Steering wheel, instrument panel, overhead console, ceiling trim, or pillar garnish trim

- Inner door seals, including speakers

Your Cadillac Service Centre and the service manual have information about the location of the airbag modules and sensors, sensing and diagnostic module, and airbag wiring along with the proper replacement procedures.

If the vehicle has rollover roof-rail airbags, see *Different Size Tyres and Wheels* ⇨ 273 for additional important information.

If the vehicle must be modified because you have a disability and have questions about whether the modifications will affect the vehicle's airbag system, or if you have questions about whether the airbag system will be affected if the vehicle is modified for any other reason, see your Cadillac Service Centre.

Airbag System Check

The airbag system does not need regularly scheduled maintenance or replacement. Make sure the airbag readiness light is working. See *Airbag Readiness Light* ⇨ 91.

Caution

If an airbag covering is damaged, opened, or broken, the airbag may not work properly. Do not open or break the airbag coverings. If there are any opened or broken airbag coverings, have the airbag covering and/or airbag module replaced. For the location of the airbags, see *Where Are the Airbags?* ⇨ 52. See your Cadillac Service Centre for service.

Replacing Airbag System Parts after a Crash

 **Warning**

A crash can damage the airbag systems in the vehicle. A damaged airbag system may not properly protect you and your passenger(s) in a crash, resulting in serious injury or even death. To help make sure the airbag systems are working properly after a crash, have them inspected and any necessary replacements made as soon as possible.

If an airbag inflates, you will need to replace airbag system parts. See your Cadillac Service Centre for service.

If the airbag readiness light stays on after the vehicle is started or comes on when you are driving, the airbag system may not work properly. Have the vehicle serviced right away. See *Airbag Readiness Light* ⇨ 91.

Warning

Safety procedures must be followed at all times when disposing of the vehicle or vehicle parts. Disposal should be performed only by an authorised service centre, to help protect the environment and your health.

Child Restraints

Older Children



Correct Seat Belt Use for Older Children

To verify if a child is able to use a lap-shoulder belt, make sure the child's knees fold comfortably on the edge of the seat. The shoulder belt should be positioned between the neck and the child's arm and the lap belt as low as possible over the child's hip.

Danger

- Accident statistics show that children are safer if they are in the rear seat and using a seat belt in a suitable way.
- Children not wearing a seat belt can be thrown out in a crash.
- Whenever a child is occupying a seat, the lap belt should be in a low position close to the hips, touching the child's thighs. This prevents loading to the abdomen in a crash.



⚠ Danger

This picture shows a child seated in a seat with a lap-shoulder belt used incorrectly. If a child uses the belt this way, in a crash the child can suffer injuries and risk of death.

Infants and Young Children

Everyone in a vehicle needs protection! This includes infants and all other children. Neither the distance travelled nor the age and size of the traveller changes the need, for everyone, to use safety restraints.

⚠ Warning

Children can be seriously injured or killed if the shoulder belt is worn behind their back, under their legs, or wrapped around their neck. Never leave children unattended in a vehicle and never allow children to improperly wear, or play with, the seat belts.

Every time infants and young children ride in vehicles, they should have the protection provided by appropriate child restraints. Neither the vehicle seat belt system nor its airbag system is designed for them.

Children who are not restrained properly can strike other people, or can be thrown out of the vehicle.

⚠ Warning

Never hold an infant or a child while riding in a vehicle. Due to crash forces, an infant or a child will become so heavy it is not possible to hold it during a crash. For example, in a crash at only 40 km/h (25 mph), a 5.5 kg (12 lb) infant will suddenly become a 110 kg (240 lb) force on a person's arms. An infant or child should be secured in an appropriate child restraint.

**⚠ Warning**

Children who are up against, or very close to, any airbag when it inflates can be seriously injured or killed. Never put a rear-facing child restraint in the front outboard seat. Secure a rear-facing child restraint in a rear seat. It is also better to secure a forward-facing child restraint in a rear seat. If you must secure a forward-facing child restraint in the front outboard seat, always move the front passenger seat as far back as it will go.



Child restraints are devices used to restrain, seat, or position children in the vehicle and are sometimes called child seats or car seats.

There are three basic types of child restraints:

- Forward-facing child restraints
- Rear-facing child restraints
- Belt-positioning booster seats

The proper child restraint for your child depends on their size, weight, and age, and also on whether the child restraint is compatible with the vehicle in which it will be used.

For each type of child restraint, there are many different models available. When purchasing a child restraint, be sure it is designed to be used in a motor vehicle and is designed by a genuine child restraint manufacturer.

The instruction manual that is provided with the child restraint states the weight and height limitations for that particular child restraint. In addition, there are many kinds of child restraints available for children with special needs.

Warning

To reduce the risk of neck and head injury in a crash, infants and toddlers should be secured in a rear-facing child restraint until age two, or until they reach the maximum height and weight limits of their child restraint.

Warning

A young child's hip bones are still so small that the vehicle seat belt may not remain low on the hip bones, as it should. Instead, it may settle up around
(Continued)

Warning (Continued)

the child's abdomen. In a crash, the belt would apply force on a body area that is unprotected by any bony structure. This alone could cause serious or fatal injuries. To reduce the risk of serious or fatal injuries during a crash, young children should always be secured in an appropriate child restraint.

Child Restraint Systems

Infants and children should be placed in the rear seat and properly restrained, according to the terms in this manual.

A young child's hip bones are so small that the vehicle regular seat belt may not remain low on the hip bones, as it should. Instead, there is a possibility that it will load the abdomen and cause serious or fatal injury in a crash.



⚠ Danger

NEVER use a rearward-facing child restraint on a seat protected by an ACTIVE AIRBAG in front of it; DEATH or SERIOUS INJURY to the CHILD can occur.

⚠ Danger

If using a rear-facing child restraint on the front passenger seat, the airbag for the front passenger seat must be deactivated. This also applies to certain forward-facing child restraints as indicated in the tables listed in this manual.

⚠ Danger

If your vehicle has a passenger airbag on-off switch and you are using a rear-facing child restraint on the front passenger seat, the airbag for the front passenger seat must be deactivated. This also applies to certain forward-facing child restraints as indicated in the tables listed in this manual.

If your vehicle does not have a passenger airbag on-off switch, do not place a rear-facing child restraint on the front passenger seat.

A child in a rear-facing child restraint can be seriously injured or killed if the front outboard passenger frontal airbag inflates. This is because the back of the rear-facing child restraint would be very close to the inflating airbag. A child in a forward-facing child restraint can be seriously injured or killed if the front outboard passenger frontal airbag inflates and the passenger seat is in a forward position.

See *Airbag On-Off Switch* ⇨ 55.

When a child restraint is being used, pay attention to the following usage and installation instructions and also those supplied with the child restraint.

Always comply with local or national regulations. In some countries, the use of child restraints is forbidden on certain seats.

Group	Weight Class
Group 0	Up to 10 kg (22 lb)
Group 0+	Up to 13 kg (28 lb)
Group I	9 to 18 kg (20 to 39 lb)
Group II	15 to 25 kg (34 to 55 lb)
Group III	22 to 36 kg (49 to 79 lb)

A



B



C

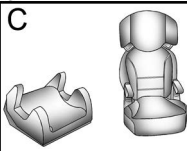

Model A : Group 0 and 0+ – Baby Seat

Model B : Group I – Child Seat

Model C : Group II and III – Booster Seat

Child restraints are designed to be fastened with the lap-shoulder belt or the ISOFIX anchors. Some child restraints also use a top tether or support leg.

Child Restraint Classification

For reference, child restraints available in the market are classified based on the child's mass. Carefully observe the installation and usage instructions given by the child restraint manufacturer.

When choosing a child restraint, it is important to consider the child's height in addition to its age and mass.

Danger

- Make sure that the child restraint is installed properly. If the child restraint is not properly attached, the risk of serious injury in the event of a collision increases.
- Do not attach or place objects or other materials on the child restraint.
- Do not leave any loose objects in the vehicle. During an impact, an object may move and cause injuries to the occupants.
- After a crash, it is necessary to replace the child restraint because it may have suffered non-visible damage.
- Always restrain your child in a properly installed child restraint, even on short trips.
- Allow children to enter and exit the vehicle only on the side facing away from traffic.

 **Warning**

- When carrying a child, follow the procedures for the transport of children established by the local laws.
- In some countries, the use of child restraints is forbidden on certain seats.
- After removing the child from the vehicle, keep the child restraint attached with the seat belt or ISOFIX, in order to avoid the child restraint from being thrown forward in case of sudden braking.

Make sure that the child restraint:

- Is installed in accordance with the instructions given by the child restraint manufacturer.
- Has the label of approval of safety regulations certification, in terms of the local laws.
- Is suitable for your vehicle.

Selecting the Right Child Restraint

The rear seats are a safer location to fasten a child restraint.

Children should travel facing rearward in the vehicle to as late an age as possible. This makes sure that the child's backbone, which is still very weak, is under less strain in the event of a crash.

General Motors recommends using a genuine GM child restraint. Contact your Cadillac Brand Ambassador for information about the child restraint accessory.

Ensure that the child restraint to be installed is compatible with the vehicle type.

Make sure that the mounting location of the child restraint within the vehicle is correct as per the tables included in this manual. See *Where to Put the Restraint* ⇨ 65.

The provisions established by the laws have priority over the provisions of this manual.

 **Danger**

Never use a single seat belt with an adult and a child. During an impact, the seat belt will exert strong pressure on the child, causing serious or fatal injury.

Never allow two children to share the same seat belt. Both could suffer serious injuries in a crash.

 **Danger**

Infants and children must never be carried on the lap of another occupant.

Although an infant does not weigh much, it will be so heavy during a crash that it will be impossible to hold it, even if the occupant is attached to the seat belt.



Where to Put the Restraint



! Danger

NEVER use a rearward-facing child restraint on a seat protected by an **ACTIVE AIRBAG** in front of it; **DEATH** or **SERIOUS INJURY** to the **CHILD** can occur.

FR: NE JAMAIS utiliser un siège d'enfant orienté vers l'arrière sur un siège protégé par un COUSSIN GONFLABLE ACTIF placé devant lui, sous peine d'infliger des BLESSURES GRAVES, voire MORTELLES à l'ENFANT.

DE: Nach hinten gerichtete Kindersitze NIEMALS auf einem Sitz verwenden, der durch einen davor befindlichen AKTIVEN AIRBAG geschützt ist, da dies den TOD oder SCHWERE VERLETZUNGEN DES KINDES zur Folge haben kann.

ES: NUNCA utilice un sistema de retención infantil orientado hacia atrás en un asiento protegido por un AIRBAG FRONTAL ACTIVO. Peligro de MUERTE o LESIONES GRAVES para el NIÑO.

SV: Använd ALDRIG en bakåtvänd barnstol på ett säte som skyddas med en framförvarande AKTIV AIRBAG. DÖDSFALL eller ALLVARLIGA SKADOR kan drabba BARNET.

IT: Non usare mai un sistema di sicurezza per bambini rivolto all'indietro su un sedile protetto da AIRBAG ATTIVO di fronte ad esso: pericolo di MORTE o LESIONI GRAVI per il BAMBINO!

NL: Gebruik NOOIT een achterwaarts gericht kinderzitje op een stoel met een ACTIEVE AIRBAG ervoor, om DODELIJK of ERNSTIG LETSEL van het KIND te voorkomen.

DA: Brug ALDRIG en bagudvendt autostol på et forsæde med AKTIV AIRBAG, BARNET kan komme i LIVSFARE eller komme ALVORLIGT TIL SKADE.

CS: NIKDY nepoužívejte dětský zádržný systém instalovaný proti směru jízdy na sedadle, které je chráněno před sedadlem AKTIVNÍM AIRBAGEM. Mohlo by dojít k VÁŽNĚMU PORANĚNÍ nebo ÚMRTÍ DÍTĚTE.

RU: ЗАПРЕЩАЕТСЯ устанавливать детское удерживающее устройство лицом назад на сиденье автомобиля, оборудованном фронтальной подушкой безопасности, если ПОДУШКА НЕ ОТКЛЮЧЕНА! Это может привести к СМЕРТИ или СЕРЬЕЗНЫМ ТРАВМАМ РЕБЕНКА.

FI: ÄLÄ KOSKAAN sijoita taaksepäin suunnattua lasten turvaistuinta istuimelle, jonka edessä on AKTIIVINEN TURVATYYNY, LAPSI VOI KUOLLA tai VAMMAUTUA VAKAVASTI.

NO: Bakoverendt barnesikringsutstyr må ALDRI brukes på et sete med AKTIV KOLLISJONSPUTE foran, da det kan føre til at BARNET utsettes for LIVSFARE og fare for ALVORLIGE SKADER.

PT: NUNCA use um sistema de retenção para crianças voltado para trás num banco protegido com um AIRBAG ACTIVO na frente do mesmo, poderá ocorrer a PERDA DE VIDA ou FERIMENTOS GRAVES na CRIANÇA.

EL: ΠΟΤΕ μη χρησιμοποιείτε παιδικό κάθισμα ασφαλείας με φορά προς τα πίσω σε κάθισμα που προστατεύεται από μετωπικό ΕΝΕΡΓΟ ΑΕΡΟΣΑΚΟ, διότι το παιδί μπορεί να υποστεί ΘΑΝΑΣΙΜΟ ή ΣΟΒΑΡΟ ΤΡΑΥΜΑΤΙΣΜΟ.

PL: NIE WOLNO montować fotelika dziecięcego zwróconego tyłem do kierunku jazdy na fotelu, przed którym znajduje się WŁĄCZONA PODUSZKA POWIETRZNA. Niezastosowanie się do tego zalecenia może być przyczyną ŚMIERCI lub POWAŻNYCH OBRAŻEŃ u DZIECKA.

TR: Arkaya bakan bir çocuk emniyet sistemini KESİNLİKLE önünde bir AKTİF HAVA YASTIĞI ile korunmakta olan bir koltukta kullanmayınız. ÇOCUK ÖLEBİLİR veya AĞIR ŞEKİLDE YARALANABİLİR.

UK: НИКОЛИ не використовуйте систему безпеки для дітей, що встановлюється обличчям назад, на сидінні з УВІМКНЕНОЮ ПОДУШКОЮ БЕЗПЕКИ, інакше це може призвести до СМЕРТІ чи СЕРІОЗНОГО ТРАВМУВАННЯ ДИТИНИ.

HU: SOHA ne használjon hátrafelé néző biztonsági gyerekülést előlről AKTÍV LÉGZSÁKKAL védett ülésen, mert a GYERMEK HALÁLÁT vagy KOMOLY SÉRÜLÉSÉT okozhatja.

HR: NIKADA nemojte koristiti sustav zadržavanja za djecu okrenut prema natrag na sjedalu s AKTIVNIM ZRAČNIM JASTUKOM ispred njega, to bi moglo dovesti do SMRTI ili OZBIJNJIH OZLJEEDA za DIJETE.

SL: NIKOLI ne nameščajte otroškega varnostnega sedeža, obrnjenega v nasprotni smeri vožnje, na sedež z AKTIVNO ČELNO ZRAČNO BLAZINO, saj pri tem obstaja nevarnost RESNIH ali SMRTNIH POŠKODB za OTROKA.

SR: NIKADA ne koristiti bezbednosni sistem za decu u kome su deca okrenuta unazad na sedištu sa AKTIVNIM VAZDUŠNIM JASTUKOM ispred sedišta zato što DETE može da NASTRADA ili da se TEŠKO POVREDI.

MK: НИКОГАШ не користете детско седиште свртено наназад на седиште заштитено со АКТИВНО ВОЗДУШНО ПЕРНИЧЕ пред него, затоа што детето може ДА ЗАГИНЕ или да биде ТЕШКО ПОВРЕДЕНО.

BG: НИКОГА не използвайте детска седалка, гледаща назад, върху седалка, която е защитена чрез АКТИВНА ВЪЗДУШНА ВЪЗГЛАВНИЦА пред нея - може да се стигне до СМЪРТ или СЕРИОЗНО НАРАНЯВАНЕ на ДЕТЕТО.

RO: Nu utilizați NICIODATĂ un scaun pentru copil îndreptat spre partea din spate a mașinii pe un scaun protejat de un AIRBAG ACTIV în fața sa; acest lucru poate duce la DECESUL sau VĂTĂMAREA GRAVĂ a COPILULUI.

SK: NIKDY nepoužívajte detskú sedačku otočenú vzad na sedadle chránenom AKTÍVNYM AIRBAGOM, pretože môže dôjsť k SMRTI alebo VÁŽNYM ZRANENIAM DIETĎA.

LT: JOKIU BŪDU nemontuokite atgal atgręžtos vaiko tvirtinimo sistemos sėdynėje, prieš kurią įrengta AKTYVI ORO PAGALVĖ, nes VAIKAS GALI ŽŪTI arba RIMTAI SUSIŽALOTI.

LV: NEKĀDĀ GADĪJUMĀ neizmantojiet uz aizmuguri vērstu bērnu sēdekliņi sēdvietā, kas tiek aizsargāta ar tās priekšā uzstādītu AKTĪVU DROŠĪBAS SPILVENU, jo pretējā gadījumā BĒRNS var gūt SMAGAS TRAUMAS vai IET BOJĀ.

ET: ÄRGE kasutage tahapoole suunatud lapseturvaistet istmel, mille ees on AKTIIVSE TURVAPADJAGA kaitstud iste, sest see võib põhjustada LAPSE SURMA või TÕSISE VIGASTUSE.

MT: QATT tuża trażżin għat-tfal li jħares lejn in-naħa ta' wara fuq sit protett b'AIRBAG ATTIV quddiemu; dan jista' jikkawż l-MEWT jew ĠIEĦ SERJI lit-TFAL.

GA: Ná húsáid srian sábháilteachta linbh cúil RIAMH ar shuíochán a bhfuil mála aeir ag feidhmiú os a chomhair.Tá baol BÁIS nó GORTÚ DONA don PHÁISTE ag baint leis.

Danger

If using a rear-facing child restraint on the front passenger seat, the airbag for the front passenger seat must be deactivated. This also applies to certain forward-facing child restraints as indicated in the tables listed in this manual.

The following table shows permissible options for fastening a child restraint with a lap-shoulder belt, permissible options for fitting an ISOFIX child restraint with ISOFIX anchors, and permissible i-Size locations.

Child Restraint Suitability

Seating Position						
Seat Position Number	1	2	3	4	5	6
Seating Position Suitable for Universal Belted (Yes/No)	N/A	N/A	No	Yes	Yes	Yes
i-Size Seating Position (Yes/No)	N/A	N/A	No	No	No	No
Seating Positions Suitable for Lateral Fixture (L1/L2)	N/A	N/A	X	X	X	X
Largest Suitable Rearward Facing Fixture (ISO R1/R2X/R2/R3)	N/A	N/A	X	R3	X	R3
Largest Suitable Forward Facing Fixture (F2X/F2/F3)	N/A	N/A	X	F3	X	F3
Largest Suitable Booster Fixture (B2/B3)	N/A	N/A	X	B3	B3	B3

Child Restraint Suitability (cont'd)

Legend and Footnotes
N/A: This ISOFIX seating position does not exist in this vehicle.
X: No child restraint permitted in this mass group.
L1: Left lateral facing position child restraint system (carry-cot)
L2: Right lateral facing position child restraint system (carry-cot)
R1: Rearward facing Infant child restraint system
R2X: Reduced-size rearward facing toddler child restraint system
R2: Reduced-size rearward facing toddler child restraint system
R3: Full-size rearward facing toddler child restraint system
F2: Reduced-height forward facing toddler child restraint system
F2X: Reduced-height forward facing toddler child restraint system
F3: Full-height forward facing toddler child restraint system
B2: Booster seat, reduced width 440mm
B3: Booster seat, full width 520mm

Seat Number	Position in the Vehicle
1	Driver
2	Front Centre

3	Front Outboard Passenger
4	Second Row Left

5	Second Row Centre
6	Second Row Right

ISOFIX size class and seat device:

ISO/F3: Forward-facing child restraint for children of maximum size in the weight class 9 to 18 kg.

ISO/F2: Forward-facing child restraint for smaller children in the weight class 9 to 18 kg.

ISO/F2X: Forward-facing child restraint for smaller children in the weight class 9 to 18 kg.

ISO/R3: Rear-facing child restraint for children of maximum size in the weight class up to 18 kg.

ISO/R2: Rear-facing child restraint for smaller children in the weight class up to 18 kg.

ISO/R2X: Reduced-size Rearward Facing Toddler CRS

ISO/R1: Rear-facing child restraint for young children in the weight class up to 13 kg.

ISO/L1: Left lateral-facing position child restraint (carry-cot).

ISO/L2: Right lateral-facing position child restraint (carry-cot).

ISOFIX Child Restraint Systems



Rear Seat

The ISOFIX anchors are located near the crease between the backrest and the seat cushion and identified with the symbol .

Fasten ISOFIX child restraints to the ISOFIX anchors.

Specific vehicle ISOFIX child restraint positions are marked in the “ISOFIX Child Restraint Systems Installation Suitability” table. See *Where to Put the Restraint* ⇨ 65.

Securing a Child Restraint to the ISOFIX Anchors

1. Position the child restraint on the front of the seat on which it will be installed.

2. Lock the ISOFIX attachments to the ISOFIX anchors following the instructions that came with the child restraint.
3. Ensure the child restraint is securely mounted to the seat.
4. A top tether strap or support leg must be used in addition to the ISOFIX anchors.

Top Tether Anchors of Vehicle

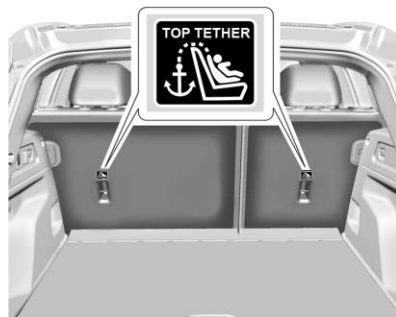

Top tether anchors are located on the back of the second row backrests and are always aligned with rear seats and identified with symbol .

Do not attach anything other than a child restraint system to the vehicle top tether anchors.

Instructions for attaching the child restraint to the top tether anchor:

1. If the child restraint manufacturer recommends that a top tether be attached, attach and tighten the top tether to the top tether anchor, if equipped. Refer to the child restraint instructions and the following steps:
 - 1.1. Find the top tether anchor.
 - 1.2. Route, attach and tighten the top tether according to your child restraint instructions and the following instructions:

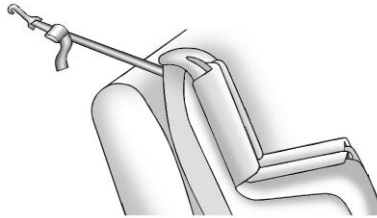

- If the position you are using does not have a head restraint and you are using a single tether, route the tether over the backrest.

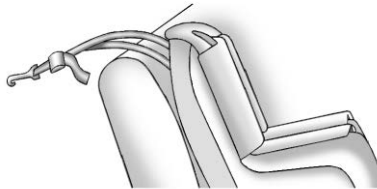

- If the position you are using does not have a head restraint and you are using a dual tether, route the tether over the backrest.

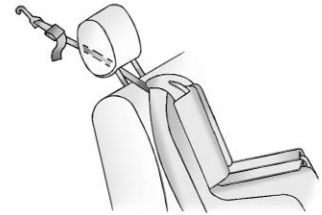

- If the position you are using has an adjustable head restraint and you are using a single tether, raise the head restraint and route the tether under the head restraint and in between the head restraint posts.

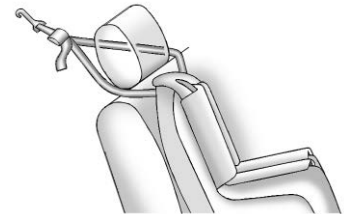

- If the position you are using has an adjustable head restraint and you are using a dual tether, raise the head restraint and route the tether around the head restraint posts.

If the child restraint is installed next to a centre seat, make sure the top tether does not interfere with the centre seating position shoulder belt/retractor. If it does, find another suitable seating position to install the child restraint.

2. Make sure the child restraint top tether hook is completely closed and secured to the top tether anchor.

Securing Child Restraints

The rear seats are the most convenient location to fasten a child restraint. See *Where to Put the Restraint* ⇨ 65.

Infants and children should be placed in the rear seat and properly restrained, according to the terms in this manual.

Danger

NEVER use a rearward-facing child restraint on a seat protected by an ACTIVE AIRBAG in front of it; DEATH or SERIOUS INJURY to the CHILD can occur.

Danger

If using a rear-facing child restraint on the front passenger seat, the airbag for the front passenger seat must be deactivated. This also applies to certain forward-facing child restraints as indicated in the tables listed in this manual.

See *Airbag On-Off Switch* ⇨ 55.

If the child restraint uses a top tether, see *Where to Put the Restraint* ⇨ 65 for top tether anchor locations.

Do not secure a child restraint in a position without a top tether anchor if a national or local law requires that the top tether must be anchored, or if the instructions that come with the child restraint say that the top tether must be anchored.

When using the lap-shoulder belt to secure the child restraint in this position, follow the instructions that came with the child restraint and the following instructions:

1. Put the child restraint on the seat.
2. Pick up the latch plate and run the lap and shoulder portions of the vehicle seat belt through or around the child restraint. Ensure the seat belt webbing is

routed as direct as possible, and is not caught on seat handles or plastic trim. The child restraint instructions will show you how.

3. Push the latch plate into the buckle until it clicks.

Position the release pushbutton on the buckle, away from the child restraint system, so that the seat belt could be quickly unfastened if necessary.

The release pushbutton used to release the latch plate must be visible and not obscured by the child restraint. There must not be direct contact of the child restraint to the release pushbutton.

4. Follow the instructions in the child restraint owner's manual to tighten and lock the child restraint when using the vehicle seat belt.
5. If the child restraint has a top tether, follow the child restraint manufacturer's instructions regarding the use of the top tether. See *ISOFIX Child Restraint Systems* ⇨ 70.
6. Before placing a child in the child restraint, make sure it is securely held in place. Push and pull the child restraint in different directions to be sure it is secure.

To remove the child restraint, follow the instructions in the child restraint owner's manual to unlock it. Unfasten the vehicle seat belt and let it return to the stowed position. If the top tether is attached to a top tether anchor, disconnect it.

Storage

Storage Compartments

Storage Compartments	74
Instrument Panel Storage	74
Glove Box	74
Cupholders	75
Centre Console Storage	75

Additional Storage Features

Cargo Cover	75
Cargo Tie-Downs	77
Cargo Management System	77
Warning Triangle	77

Roof Rack System

Roof Rack System	77
------------------------	----

Storage Compartments

⚠ Warning

Do not store heavy or sharp objects in storage compartments. In a crash, these objects may cause the cover to open and could result in injury.

Instrument Panel Storage



If equipped, there is an upper sliding drawer and a lower storage bin in the centre of the instrument panel.

Glove Box

To open the glove box, press the Glove Box Release button on the controls home page of the infotainment screen or tap Controls > Doors & Windows > Glove Box Release.

If the vehicle is stationary, a Glove Box Release icon appears on the infotainment home screen. Tap the icon to open the glove box.

If the vehicle is off, you can still open the glove box. Press the volume button or the Multi-function Controller (MFC) to wake the infotainment home screen and access the virtual Glove Box Release button.

To close the glove box, push the glove box up until it latches.

If the 12-volt battery is dead, the glove box will not open. See *Jump Starting* ⇨ 275.

Cupholders

The front cupholders are in the centre console.



If equipped, lower the armrest to access the rear cupholders.

Centre Console Storage



Lift the armrest up to access the storage area.

There is a USB port, an SD card reader, and an auxiliary power socket. If equipped, the front of the console may also have an additional USB port.

Additional Storage Features

Cargo Cover

Warning

An unsecured cargo cover could strike people in a sudden stop or turn, or in a crash. Store the cargo cover securely or remove it from the vehicle.

Warning

Do not place objects on the cargo cover. Sudden stops or turns can cause objects to be thrown in the vehicle. You or others could be injured.



If equipped, use the cargo cover to cover items in the rear of the vehicle.

Install the Cargo Cover

1. Hold the cartridge so that the retracted cargo cover faces the rear of the vehicle.
2. Align the cartridge over the slots on the trim panels of the vehicle.
3. Place one end of the cartridge into the slot and then compress to fit the other end into the remaining slot.
4. Unroll the cargo cover toward the rear of the vehicle.

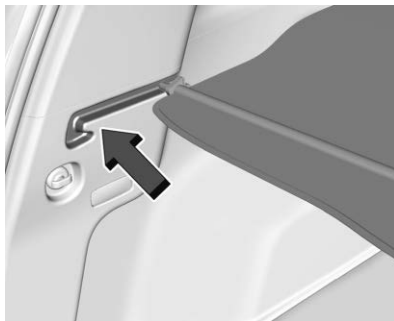

5. Insert the cargo cover pins into the channels on both sides.

Remove the Cargo Cover

Remove the cargo cover pins from the channels and let the cover retract. Compress the ends of the cartridge to remove it from the slots.

Store the Cargo Cover

To store the cargo cover:



1. Press the buttons on both ends until locked.



2. Store under the load floor.

To reinstall, press the buttons to unlock the ends of the cover, and then follow the installation procedure.

Cargo Tie-Downs



The vehicle has four cargo tie-downs in the rear compartment.

Cargo Management System



There is storage under the load floor.



Press the handle and pull up the load floor to access.

Caution

Overloading the cargo management system can cause damage to the vehicle. Do not place cargo that weighs more than 20 kg (44 lb) in the bin or on top of the plastic lid (if equipped).

Warning Triangle

The warning triangle is stored in the rear of the vehicle under the load floor.

Roof Rack System

The vehicle body side is marked for a cross rail system. Cargo must be secured with properly installed cross rails and other accessories designed to carry cargo. These can be purchased from your Cadillac Brand Ambassador.

Warning

Before driving and occasionally during a trip, check that the cargo is securely fastened, that it rests evenly between the
(Continued)

Warning (Continued)

cross rails and does not block the vehicle's lights or windows. Never load cargo directly on the roof of the vehicle or allow cargo to hang over the rear or sides of the vehicle. Never load cargo without first properly installing cross rails and other accessories designed to carry cargo. Personal injury, death or damage to the vehicle or other property may occur.

If driving for a long distance, on rough roads, or at high speeds, occasionally stop the vehicle to make sure the cargo remains in its place.

Cargo Weight Limits

Do not exceed the maximum cargo weight for the roof rack system, which includes the weight of the cross rails and any other accessories used to carry the cargo such as bike racks or roof boxes. The maximum cargo weight that can be loaded onto the roof rack system is 50 kg (110 lb) or the weight designated in the instructions that came with the cross rails or other roof rack accessories, whichever is less.

 **Warning**

Never load the roof rack with more weight than specified in this section. Loading cargo on the roof rack will make the vehicle's centre of gravity higher. To avoid losing control of the vehicle, avoid overloading, high speeds, sudden starts, sharp turns, sudden braking, or abrupt manoeuvres when carrying cargo on the roof rack.

The weight of any cargo carried on the roof rack system must be included in calculating the loaded weight of the vehicle. Do not exceed the maximum vehicle capacity when loading the vehicle, including cargo carried on the roof rack system and passengers and cargo carried in the vehicle. For more information on vehicle capacity and loading, see *Vehicle Load Limits* ⇨ 155.

Instruments and Controls

Controls

Steering Wheel Adjustment	80
Heated Steering Wheel	80
Horn	81
Pedestrian Safety Signal	81
Windscreen Wiper/Washer	81
Compass	82
Clock	82
Power Sockets	82
Wireless Charging	84

Warning Lights, Gauges, and Indicators

Warning Lights, Gauges, and Indicators	86
Instrument Cluster	87
Speedometer	89
Mileometer	89
Trip Odometer	89
Battery Gauge (High Voltage)	89
Power Indicator Gauge	90
Speed Limiter Indicator	90
Seat Belt Reminders	90
Airbag Readiness Light	91
Airbag On-Off Light	92
Charging System Light (12-Volt Battery)	92
Low State of Charge Light	92
Charging cable Connected Light	93

Battery Fault Light	93
Propulsion Power is Limited Light	93
Service Vehicle Soon Light	93
Brake System Warning Light	93
Electric Parking Brake Light	94
Service Electric Parking Brake Light	94
Antilock Brake System (ABS) Warning Light	94
All-Wheel-Drive Light	95
Automatic Vehicle Hold (AVH) Light	95
Lane Keep Assist (LKA) Light	95
Automatic Emergency Braking (AEB) Disabled Light	95
Vehicle Ahead Indicator	96
Pedestrian Ahead Indicator	96
Traction Off Light	96
Traction Control System (TCS)/Electronic Stability Control Light	96
Electronic Stability Control (ESC) Off Light	97
Driver Mode Control Light	97
Tyre Pressure Light	97
Security Light	98
Vehicle Ready Light	98
Main-Beam On Light	98
Adaptive Forward Lighting (AFL) Light	98
Rear Fog Lamp Light	99
Lamps On Reminder	99
Cruise Control Light	99

Driver Attention Assist Light	99
Door Ajar Light	100

Information Displays

Charging	100
Driver Information Centre (DIC)	105
Vehicle Status	106
Head-Up Display (HUD)	108

Vehicle Messages

Vehicle Messages	110
Propulsion Power Messages	111
Vehicle Speed Messages	112

Controls

Steering Wheel Adjustment



To adjust the steering wheel, if equipped:

1. Pull the lever down.
2. Move the steering wheel up or down.
3. Pull or push the steering wheel closer or away from you.
4. Pull the lever up to lock the steering wheel in place.

Do not adjust the steering wheel while driving.

Power Tilt and Telescoping Steering Wheel



To adjust the steering wheel, if equipped:

1. Press the control up or down to tilt the steering wheel up or down.
2. Press the control rearward or forward to move the steering wheel closer or away from you.

Do not adjust the steering wheel while driving.

Heated Steering Wheel



 : Press to turn the heated steering wheel on or off. An indicator next to the button is lit when the feature is turned on.

The steering wheel takes about three minutes to start heating.

Automatic Heated Steering Wheel

The heated steering wheel may turn on during a remote start along with the heated seats when it is cold outside. The heated steering wheel indicator may come on in remote start.

The heated steering wheel will turn on when the auto heated seat is activated. The heated steering wheel indicator will display the state of the steering wheel heat.

See *Heated and Ventilated Front Seats* ⇨ 40.

To turn this feature on or off, select Settings > Vehicle > Comfort and Convenience > Heated Steering Wheel > Select ON or OFF.

Horn

To sound the horn, press  on the steering wheel.

Pedestrian Safety Signal

The vehicle is equipped with automatic sound generation. The automatic sound is generated to indicate the vehicle presence to pedestrians. The sound changes if the vehicle is speeding up or slowing down. It is activated when the vehicle is shifted into a forward gear, N (Neutral), or R (Reverse), up to driving speeds of 34 km/h (21 mph).

Windscreen Wiper/Washer

This vehicle is equipped with Rainsense and a sensor near the top centre of the windscreen detects the amount of water on

the windscreen and controls the frequency of the windscreen wiper based on the current sensitivity setting.

Keep this area of the windscreen clear of debris to allow for best system performance.

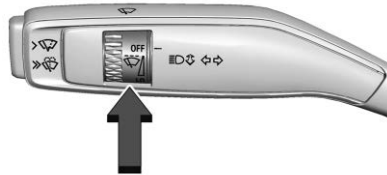

Base Windscreen/Washer Lever Shown

With the vehicle on, turn the windscreen wiper band to select the wiper speed.

OFF : Use to turn the wipers off.

LO : Use for slow wipes.

HI : Use for fast wipes.

Turn the band to select the frequency of intermittent wipes between OFF and LO.

Clear snow and ice from the wiper blades and windscreen before using them. If frozen to the windscreen, carefully loosen or thaw them. Damaged blades should be replaced. See *Wiper Blade Replacement* ⇨ 252.

Warning

In freezing weather, do not use the washer until the windscreen is warmed. Otherwise the washer fluid can form ice on the windscreen, blocking your vision.

Warning

Before driving the vehicle, always clear snow and ice from the bonnet, windscreen, washer nozzles, roof, and rear of the vehicle, including all lights and windows. Reduced visibility from snow and ice build-up could lead to a crash.

Wiper Arm Assembly Protection

When using an automatic car wash, turn the windscreen wiper band to OFF. This disables the automatic Rainsense windscreen wipers.

With Rainsense, if the vehicle is in N (Neutral) and the speed is very slow, the wipers will automatically stop at the base of the windscreen.

The wiper operations return to normal when the vehicle is no longer in N (Neutral) or the vehicle speed has increased.

Windscreen Washer



>  : For a single wipe, push the button on the side of the windscreen to the first stop position briefly and then release. For several wipes, keep holding at the first stop position for longer and then release.

>>  : Push the button on the side of the windscreen wiper lever all the way to the end, beyond the first stop position, to spray washer fluid and activate the wipers. When the button is released, additional wipes may occur depending on how long the windscreen washer had been activated. See *Washer Fluid* ⇨ 247 for information on filling the windscreen washer fluid reservoir.

Wiper Parking

If the vehicle is turned off while the wipers are on LO or HI, they will immediately stop.

If the windscreen wiper lever is then moved to OFF before the driver door is opened or within 10 minutes, the wipers will restart and move to the base of the windscreen.

If the vehicle is turned off while the wipers are performing wipes due to windscreen washing or Rainsense, the wipers continue to run until they reach the base of the windscreen.

Rear Camera Washer

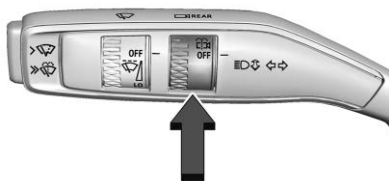

If equipped, turn the band to  to spray washer fluid on the rear camera lens. Release the band when done. See *Rear Camera Mirror* ⇨ 28.

Compass

The vehicle may have a compass display on the Driver Information Centre (DIC). The compass receives its heading and other

information from the Global Positioning System (GPS) aerial, StabiliTrak/Electronic Stability Control (ESC), and vehicle speed information.

The compass system is designed to operate for a certain number of miles or degrees of turn before needing a signal from the GPS satellites. When the compass display shows CAL, drive the vehicle for a short distance in an open area where it can receive a GPS signal. The compass system will automatically determine when a GPS signal is restored and provide a heading again.

Clock

Set the time and date using the infotainment system. See "Date/Time" under *Settings* ⇨ 137.

Power Sockets

Power Outlets 12-Volt Direct Current

The vehicle has two 12-volt sockets that can be used to plug in electrical equipment, such as a mobile phone or MP3 player.



Centre Console

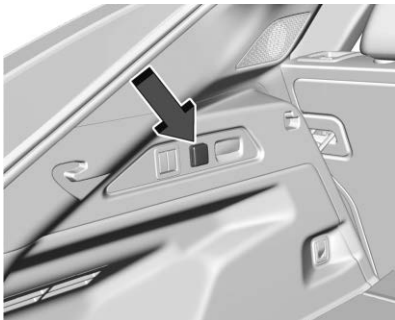

Rear Cargo Area

The power sockets are located:

- Inside of the centre console.

- In the rear cargo area.
- Lift the cover to access the socket and replace when not in use.

Warning

Power is always supplied to the rear cargo power socket. Do not leave electrical equipment plugged in when the vehicle is not in use because the vehicle could catch fire and cause injury or death.

Caution

Leaving electrical equipment plugged in for an extended period of time while the vehicle is off will drain the battery. Always unplug electrical equipment when not in use and do not plug in equipment that exceeds the maximum 15 amp rating.

Certain accessory plugs may not be compatible with the accessory power socket and could overload vehicle and adapter fuses. If a problem is experienced, see your Cadillac Brand Ambassador.

When adding electrical equipment, ensure that you follow the proper installation instructions included with the equipment. See *Add-On Electrical Equipment* ⇨ 240.

Caution

Hanging heavy equipment from the power outlet can cause damage not covered by the vehicle warranty. The power outlets are designed for accessory power plugs only, such as mobile phone charge cords.

Power Socket 110-Volt/120-Volt Alternating Current

If equipped with this power socket it can be used to plug in electrical equipment that uses a maximum limit of 150 watts.

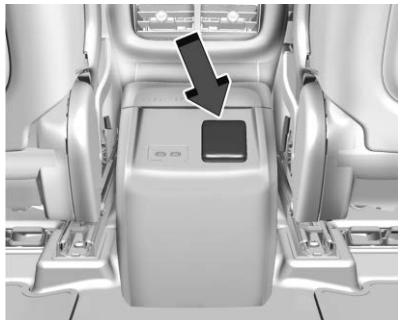

The power outlet is on the rear of the centre console.

An indicator light on the outlet turns on to show it is in use. The light comes on when the vehicle is on, equipment requiring less than 150 watts is plugged into the socket, and no system fault is detected.

The indicator light does not come on when the vehicle is off or if the equipment is not fully seated into the socket.

If equipment is connected using more than 150 watts or a system fault is detected, a protection circuit shuts off the power supply and the indicator light turns off. To reset the circuit, unplug the item and plug it back in or turn the Retained Accessory Power

(RAP) off and then back on. See *Retained Accessory Power (RAP)* ⇨ 161. The power restarts when equipment using 150 watts or less is plugged into the outlet and a system fault is not detected.

The power outlet is not designed for and may not work properly, if the following are plugged in:

- Equipment with high initial peak wattage, such as compressor-driven refrigerators and electric power tools
- Other equipment requiring an extremely stable power supply, such as microcomputer-controlled electric blankets and touch sensor lamps
- Medical equipment

Wireless Charging

If equipped and enabled, the vehicle has wireless charging in front of the centre console storage bin. The system operates at 145 kHz and wirelessly charges one Qi compatible smartphone. The power output of the system is capable of charging at a rate of up to 3 amps (15 W), as requested by the compatible smartphone.

Warning

Wireless charging may affect the operation of an implanted pacemaker or other medical devices. If you have one, it is recommended to consult with your doctor before using the wireless charging system.

The vehicle must be on, in accessory mode, or Retained Accessory Power (RAP) must be active. The wireless charging feature may not correctly indicate charging when the vehicle is in RAP, during a Bluetooth phone call, or when phone projection (e.g., Apple CarPlay/Android Auto) is active. See *Retained Accessory Power (RAP)* ⇨ 161.

The operating temperature is $-40\text{ }^{\circ}\text{C}$ ($-40\text{ }^{\circ}\text{F}$) to $85\text{ }^{\circ}\text{C}$ ($185\text{ }^{\circ}\text{F}$) for the charging system and $0\text{ }^{\circ}\text{C}$ ($32\text{ }^{\circ}\text{F}$) to $35\text{ }^{\circ}\text{C}$ ($95\text{ }^{\circ}\text{F}$) for the phone. A charging stopped alert may be displayed on the infotainment screen, if the wireless charger or smartphone are outside of normal operating temperature. Charging will automatically resume when a normal operating temperature is reached.

Warning

Remove all objects from the charger before charging your compatible smartphone. Objects, such as coins, keys, rings, paper clips, or cards, between the smartphone and charger may become very hot.

On the rare occasion that the charging system does not detect an object, and that object becomes wedged between the smartphone and charger, remove the smartphone and allow the object to cool before removing it from the charger, to prevent burns.





To charge a compatible smartphone:

1. Confirm the smartphone is capable of wireless charging.
2. Remove all objects from the charging pocket. The system may not charge if there are any objects between the smartphone and charger.
3. Place the smartphone face up against the rear of the charger.

To maximise the charge rate, ensure the smartphone is fully seated and centred in the holder with nothing under it.

A thick smartphone case may prevent the charger from working, or reduce the charging performance. See your Cadillac Brand Ambassador for additional information.

4. A green  will appear on the infotainment display, next to the phone icon. This indicates that the smartphone is detected.
5. If a smartphone is placed on the charger and  turns off or a yellow triangle appears, remove the smartphone and any objects from the pocket. Turn the smartphone 180 degrees and wait a few seconds before placing/aligning it on the pocket again.

6. If a smartphone is placed on the charger and a red circle appears, the charger and/or the smartphone is overheated. Remove the smartphone and any objects from the charger in order to cool the system.

The smartphone may become warm during charging. This is normal. In warmer temperatures, the speed of charging may be reduced.

For vehicles with wireless phone projection, the smartphone may overheat during wireless charging. The smartphone may slow down, stop charging, or shut down to protect the battery. The phone may need to be removed from its case to prevent overheating. The  may flash while the phone is cooling down enough for wireless charging to automatically resume. This is normal. Individual phone performance may vary.

Certain vehicle and smartphone accessories may not be compatible with the wireless charging system. See your Cadillac Brand Ambassador for additional information.

Software Acknowledgements

Certain Wireless Charging Module products from LG Electronics, Inc. ("LGE") contain the open source software detailed below. Refer to the indicated open source licences (as are included following this notice) for the terms and conditions of their use.

OSS Notice Information

To obtain the source code that is contained in this product, please visit <https://opensource.lge.com>. In addition to the source code, all referred license terms, warranty disclaimers and copyright notices are available for download. LG Electronics will also provide open source code to you on CD-ROM for a charge covering the cost of performing such distribution (such as the cost of media, shipping, and handling) upon email request to opensource@lge.com. This offer is valid for three (3) years from the date on which you purchased the product.

Freescale-WCT library

Copyright (c) 2012-2014 Freescale Semiconductor, Inc. All rights reserved.

Redistribution and use in source and binary forms, with or without modification, is permitted provided that the following conditions are met:

1. Redistributions of source code must retain the above copyright notice, this list of conditions and the following disclaimer.
2. Redistributions in binary form must reproduce the above copyright notice, this list of conditions and the following disclaimer in the documentation and/or other materials provided with the distribution.
3. Neither the name of the copyright holder nor the names of its contributors may be used to endorse or promote products derived from this software without specific prior written permission.

THIS SOFTWARE IS PROVIDED BY THE COPYRIGHT HOLDERS AND CONTRIBUTORS "AS IS" AND ANY EXPRESS OR IMPLIED WARRANTIES, INCLUDING, BUT NOT LIMITED TO, THE IMPLIED WARRANTIES OF MERCHANTABILITY AND FITNESS FOR A PARTICULAR PURPOSE ARE DISCLAIMED. IN NO EVENT SHALL THE COPYRIGHT HOLDER OR CONTRIBUTORS BE LIABLE FOR ANY DIRECT, INDIRECT, INCIDENTAL, SPECIAL, EXEMPLARY, OR CONSEQUENTIAL DAMAGES (INCLUDING, BUT NOT LIMITED TO, PROCUREMENT OF SUBSTITUTE GOODS OR SERVICES; LOSS OF USE, DATA, OR PROFITS;

OR BUSINESS INTERRUPTION) HOWEVER CAUSED AND ON ANY THEORY OF LIABILITY, WHETHER IN CONTRACT, STRICT LIABILITY, OR TORT (INCLUDING NEGLIGENCE OR OTHERWISE) ARISING IN ANY WAY OUT OF THE USE OF THIS SOFTWARE, EVEN IF ADVISED OF THE POSSIBILITY OF SUCH DAMAGE.

Warning Lights, Gauges, and Indicators

Warning lights and gauges can signal that something is wrong before it becomes serious enough to cause an expensive repair or replacement. Paying attention to the warning lights and gauges could prevent injury.

Some warning lights come on briefly when the propulsion system is started to indicate they are working. When one of the warning lights comes on and stays on while driving, or when one of the gauges shows there may be a problem, check the section that explains what to do. Waiting to do repairs can be costly and even dangerous.

Instrument Cluster

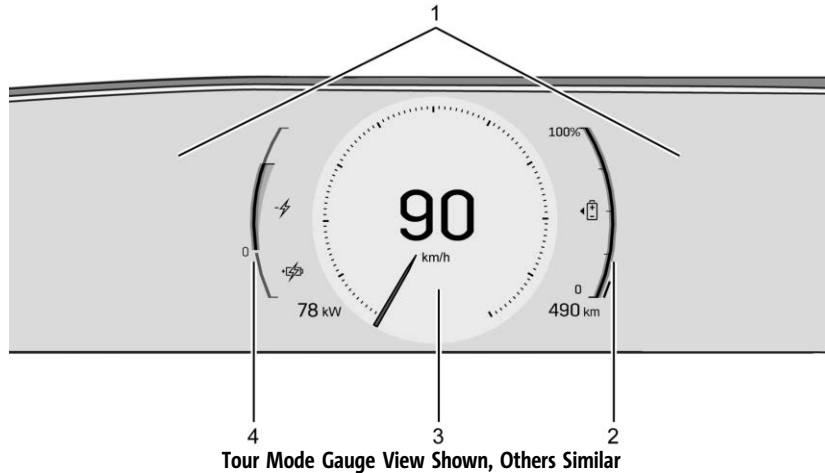

1. Driver Information Centre (DIC) ⇨ 105
2. Battery Gauge (High Voltage) ⇨ 89
3. Speedometer ⇨ 89
4. Power Indicator Gauge ⇨ 90

Reconfigurable Instrument Cluster

The instrument cluster display layout can be changed. There are two display configurations to choose from based on the driver mode selected: Tour, and Sport. To

see how to change the Driver Mode, see “Mode Activation” under *Driver Mode Control* ⇨ 171.

- Tour configuration displays the speedometer in the centre of the display. The battery gauge is located on the right of the speedometer and the power indicator gauge is on the left of it. There are two DIC areas on the left and right of the display.
- Sport configuration displays the speedometer in the centre of the display. The battery gauge is located below the speedometer and the power indicator gauge is above it. There are two DIC areas on the left and right of the display.

The following are selectable views:

Gauge : Displays information zones to the left and right of the speedometer.

Energy : Displays the energy usage of the vehicle.

Map : Displays a navigation map.

Assist : If equipped, displays driver assistance information in the left information zone. There are two gauges located on the bottom of the display.

Clean : Displays no information zones.

To change the cluster configuration, touch  on the touchscreen to the left of the instrument cluster. Select the desired option from the list.

Selecting a different view could hide the vehicle status that is displayed in the information zones on the cluster. Once a view with information zones is selected the vehicle status that was last selected will then be displayed. See *Driver Information Centre (DIC)* ⇨ 105 and *Vehicle Status* ⇨ 106.

Control Panel

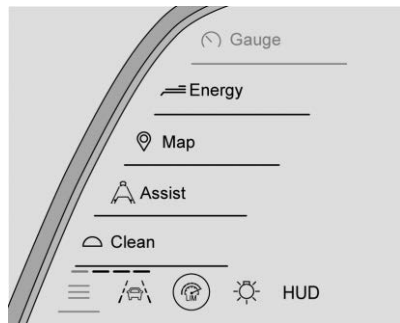

There is a touchscreen to the left of the instrument cluster. Use it for the following:

List Page

Touch  to view and select the available list options. View options by swiping right or left on the touchscreen.

Lane Keep Assist (LKA)

Touch  to select the available Lane Keep Assist (LKA) options. See *Lane Keep Assist (LKA)* ⇨ 210.

Speed Limiter

If equipped, touch  to select the available speed limiter options. See *Speed Limiter* ⇨ 194.

Headlamps

Touch  to select the available headlight options. See *Exterior Lamp Controls* ⇨ 113.

Head-Up Display (HUD)

If equipped, touch HUD to select the height and brightness of the head-up display.

Trip Information

Touch  to view distance and efficiency for the current trip. View other trip information by swiping right or left on the touchscreen.

Touch and hold to reset the current trip.

Display Settings

The following options can be turned on or off using the infotainment display. See *Settings* ⇨ 137.

Speed Information

Choose which speed-related information is shown in the instrument cluster:

Digital Speedometer : The speedometer shows how fast the vehicle is moving in either kilometres per hour (km/h) or miles per hour (mph). The speedometer cannot be reset.

Speed Sign : Shows sign information, which comes from a roadway database in the onboard navigation, if equipped. The sign will show “-” when there is no detected speed limit or the system is unavailable.

Speed Warning Colour : The overspeeding area within the analogue gauge is shown red. In digital speedometer, the digital number is shown red.

Turn-by-Turn Graphics

When on, you will see turn-by-turn navigation graphics in the instrument cluster when a route is active. These graphics provide visual directions for upcoming manoeuvres.

Traffic Sign Memory

Choose which Traffic Sign Memory information is shown in the instrument cluster:

Reset Traffic Signs : Currently displayed traffic signs will be cleared, and newly detected signs will be displayed. Touch RESET while this display is active to reset. Upon successful reset, a message will display on the infotainment screen.

Traffic Sign Detected Alert : When on, you will receive alerts when your vehicle detects traffic signs. You will hear a chime and see the sign in the instrument cluster.

Show in Info Zone : When on, you will see recently detected traffic signs displayed in the info zone of the instrument cluster. Signs may include speed limits, warning signs, school zones, and more. Select OFF if you don't want to see road signs.

Speedometer

The speedometer shows the vehicle speed in either kilometres per hour (km/h) or miles per hour (mph).

Mileometer

The odometer shows how far the vehicle has been driven, in either kilometres or miles.

Trip Odometer

The trip odometer shows how far the vehicle has been driven since the trip odometer was last reset.

The trip odometer is accessed and reset through the control panel to the left of the instrument cluster. See *Instrument Cluster* ⇨ 87.

Battery Gauge (High Voltage)

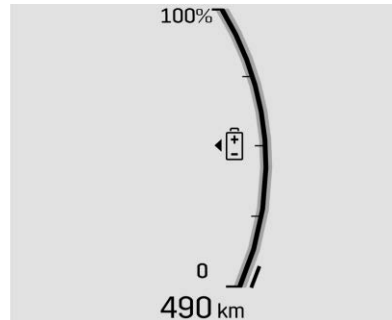

Tour Mode Gauge View Shown, Others Similar

This displays the high voltage battery state of charge. The value at the bottom is an estimate of how far the vehicle can be driven on the remaining charge based on recent driving habits, conditions, and HVAC usage.

The fill bars shown inside of the gauge indicate the percentage range as estimated from current vehicle conditions and climate settings. The range estimate on the bottom also may be affected by climate settings, current vehicle conditions and ambient conditions. Estimated range may increase and decrease based on climate control energy consumption.

Driving aggressively through hard acceleration and/or braking events, excessive HVAC usage, using heated or cooled seats, battery preconditioning, and performance modes can affect vehicle range estimates.

When the high voltage battery state of charge level gets low, the gauge will change colour to amber. When the charge is very low the gauge will change colour to red, and the estimated range value on the bottom will change to LOW. Additional alerts may display and a sound may also be heard at low state of charge.

Power Indicator Gauge

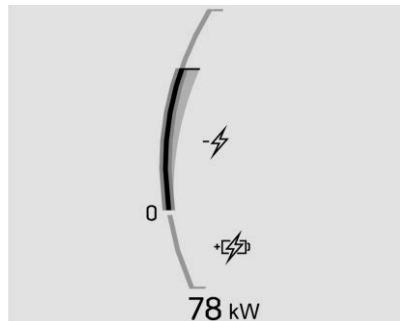

Tour Mode Gauge View Shown, Others Similar

The power indicator gauge is in the centre of the display to the left of the speedometer in the Tour mode gauge view.

This gauge displays the instantaneous charge and consumption power of the high voltage battery. Maximum power consumption is available when the high voltage battery is fully charged. During normal operation, a slight reduction in consumption power may occur as the high voltage battery state of charge decreases.

Regenerative Braking

When regenerative (regen) braking is active, the regen battery icon displays and will fill the lower section of the gauge. The power indicator gauge value shows the amount of instantaneous power being regenerated.

Regenerative Power Limited

Regenerative power may be limited when the high voltage battery is near full charge or cold. This will affect the vehicle's maximum regenerative braking power.

Speed Limiter Indicator



This light is white when the speed limiter is on and ready, and turns green when the speed limiter is set and active.

See *Speed Limiter* ⇨ 194.

Seat Belt Reminders

Driver Seat Belt Reminder Light

There is a driver seat belt reminder light on the instrument cluster.



When the vehicle is started, this light flashes and a chime may come on to remind the driver to fasten their seat belt. Then the light stays on solid until the belt is buckled. This cycle may continue several times if the driver remains or becomes unbuckled while the vehicle is moving.

If the driver seat belt is fastened, neither the light nor the chime is activated.

Front Passenger Seat Belt Reminder Light

The vehicle may have a front passenger seat belt reminder light near the passenger airbag status indicator.



When the vehicle is started, this light flashes and a chime may sound to remind passengers to fasten their seat belts. Then the light stays on solid until the belt is buckled. This cycle continues several times if the front passenger remains or becomes unbuckled while the vehicle is moving.

If the front passenger seat belt is fastened, neither the chime nor the light is activated.

The front passenger seat belt reminder light and chime may turn on if an object is placed on the seat such as a briefcase, handbag, shopping bag, laptop, or other electronic device. To turn off the reminder light and/or chime, remove the object from the seat or fasten the seat belt.

Second Row Passenger Seat Belt Reminder Lights

The vehicle may have second row passenger seat belt reminder lights.



When the vehicle is started, these lights illuminate with a solid glow to remind rear seat passengers to fasten their seat belts. Then each light may remain switched on with a solid glow or flash, and a chime may sound if a rear seat passenger remains unfastened, or becomes unfastened, when the vehicle is moving. A shaded or green light indicates the seat belt is fastened.

If all rear seat positions are fastened, neither the chime nor the lights will be activated.

The rear passenger seat belt reminder light and chime may be activated if an object is left on the seat such as a briefcase, handbag, shopping bag, and laptop, or other electronic device. To turn off the reminder light and/or chime, remove the object from the seat or fasten the seat belt.

Airbag Readiness Light

This light shows if there is an electrical problem with the airbag system.

It is located in the instrument cluster.

The system check includes the airbag sensor(s), the pretensioners, the airbag modules, the wiring, and the crash sensing and diagnostic module. For more information on the airbag system, see *Airbag System* ⇨ 50.



The airbag readiness light comes on for several seconds when the vehicle is started. If the light does not come on then, have it fixed immediately.

Warning

If the airbag readiness light stays on after the vehicle is started or comes on while driving, it means the airbag system might not be working properly. The airbags in the vehicle might not inflate in a crash, or they could even inflate without a crash. To help avoid injury, have the vehicle serviced right away.

If there is a problem with the airbag system, a Driver Information Centre (DIC) message may also come on.

Airbag On-Off Light



1. Child Restraint/Airbag Warning Symbol
2. Airbag On Symbol
3. Airbag Off Symbol

If the vehicle has an *Airbag On-Off Switch* ⇨ 55, it also has a passenger airbag status indicator located in the overhead console.

If the child restraint/airbag warning symbol and the airbag on symbol are lit, it means that the front outboard passenger frontal airbag is allowed to inflate.

The symbols will turn off after approximately one minute but the frontal airbag will still be allowed to inflate.

If the airbag off symbol is lit, it means that the airbag on-off switch has turned off the front outboard passenger frontal airbag.

If, after several seconds, all of the symbols remain lit, there may be a problem with the passenger airbag status indicator or the airbag on-off switch. See your Cadillac Service Centre for service.

Warning

If the airbag readiness light comes on and stays on, it means that something may be wrong with the airbag system. To help avoid injury to yourself or others, have the vehicle serviced right away. See *Airbag Readiness Light* ⇨ 91 for more information, including important safety information.

Charging System Light (12-Volt Battery)

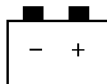

The charging system light comes on briefly when the vehicle is started, as a check to show the light is working.

If the light stays on, or comes on while driving, there could be a problem with the electrical charging system. Have it checked by your Cadillac Service Centre. Driving while this light is on could drain the 12-volt battery.

If a short distance must be driven with the light on, be sure to turn off all accessories, such as the radio. Find a safe place to stop the vehicle.

Low State of Charge Light



This light comes on when the vehicle state of charge is low. Proceed to a charging station to charge the vehicle.

Charging cable Connected Light



This light comes on when a charging cable is connected to the vehicle.

Battery Fault Light



This light indicates a fault with the high voltage battery. A message may also display in the Driver Information Centre (DIC). See your Cadillac Service Centre.

Propulsion Power is Limited Light

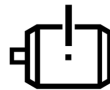

These lights display when the vehicle propulsion power is limited, which may affect the vehicle's ability to accelerate. The vehicle may be driven while these lights are on, but maximum acceleration and speed may be limited.

Service Vehicle Soon Light



This light comes on if a condition exists that may require the vehicle to be taken in for service.

If the light comes on, take the vehicle to your Cadillac Service Centre for service as soon as possible.

Brake System Warning Light



This light comes on briefly when the vehicle is turned on to show that the light is working. If it does not come on then, have it fixed so it will be ready to warn you if there is a problem.

If the light comes on and stays on, there is a brake problem. Have the brake system inspected immediately. This light may come on if the brake fluid is low. See *Brake Fluid* ⇨ 248.

If the light comes on while driving, pull off the road and stop carefully. The brake system has electric brake boost. Vehicle speed may be limited when the brake

system warning light comes on. The brake pedal might be harder to push, or the brake pedal may go closer to the floor. It could take longer to stop. If the light is still on, have the vehicle towed for service. See *Transporting a Disabled Vehicle* ⇨ 278.

Warning

The brake system might not be working properly if the brake system warning light is on. Driving with the brake system warning light on can lead to a crash. If the light is still on after the vehicle has been pulled off the road and carefully stopped, have the vehicle towed for service.

Electric Parking Brake Light



This light comes on when the parking brake is applied. If the light continues flashing after the parking brake is released or while driving, there is a problem with the Electric

Parking Brake system. A message may also display in the Driver Information Centre (DIC).

If the light does not come on, or remains flashing, see your Cadillac Service Centre.

Service Electric Parking Brake Light



This light should illuminate briefly when the vehicle is turned on. If it does not come on, have it fixed so it will be ready to warn if there is a problem.

If this light stays on or comes on while driving, there is a problem with the Electric Parking Brake (EPB). Take the vehicle to a Cadillac Service Centre as soon as possible. In addition to the parking brake, other safety functions that utilise the EPB may also be degraded. A message may also display in the Driver Information Centre (DIC). See *Electric Parking Brake* ⇨ 167.

Antilock Brake System (ABS) Warning Light



This light comes on briefly when the vehicle is turned on to show that the light is working. If it does not come on then, have it fixed so it will be ready to warn you if there is a problem.

If the ABS warning light remains turned on, or illuminates again while driving, the vehicle needs service. A chime may also sound when the light stays on.

If the ABS warning light is the only light turned on, the vehicle has regular brakes, but ABS is not functioning.

If both the ABS warning light and the brake system warning light are turned on, ABS is not functioning and there is a problem with the regular brakes. See your Cadillac Service Centre.

See *Brake System Warning Light* ⇨ 93.

All-Wheel-Drive Light

eAWD

This light is amber when the electric all-wheel drive (eAWD) system is limited, and will turn off when the system is working normally.

If this light is red, there may be a malfunction. See your Cadillac Service Centre.

See *All-Wheel Drive* ⇨ 166.

Automatic Vehicle Hold (AVH) Light

AUTO
HOLD

This light comes on when AVH is actively holding the vehicle. See *Automatic Vehicle Hold (AVH)* ⇨ 168.

Lane Keep Assist (LKA) Light



If equipped, the Lane Keep Assist Light may display the following colours:

- Blank: LKA is disabled.
- White: Appears when the vehicle starts. A continuous white light indicates that LKA is not ready to assist.
- Green: Appears when LKA is turned on and ready to assist. LKA will gently turn the steering wheel if the vehicle approaches a detected lane marking.
- Amber: Appears when LKA is active. The light flashes amber as a Lane Departure Warning (LDW) alert to indicate that the lane marking has been unintentionally crossed. If the system detects you are steering intentionally (to overtake or change lanes), the LDW alert may not display. The amber light also appears when the Blind Zone Steering Assist detects a potential collision with a

moving vehicle in the lane you are entering. See *Blind Zone Steering Assist (BZSA)* ⇨ 206.

LKA will not assist or alert if the indicator is active in the direction of lane departure, or if LKA detects that you are accelerating, braking, or actively steering. See *Lane Keep Assist (LKA)* ⇨ 210.

Automatic Emergency Braking (AEB) Disabled Light



This indicator displays when you turn off Automatic Emergency Braking (AEB) or Front Pedestrian Braking (FPB).

This indicator will also display if AEB or FPB is unavailable due to malfunction, weather conditions, or if the windscreen is not clean.

See *Automatic Emergency Braking (AEB)* ⇨ 198.

See *Front Pedestrian Braking (FPB) System* ⇨ 202.

Vehicle Ahead Indicator



If equipped, this indicator will display green when a vehicle is detected ahead and amber when you are following a vehicle ahead much too closely.

See *Forward Collision Alert (FCA) System*
⇨ 196.

Pedestrian Ahead Indicator



If equipped, this indicator will display in amber when a nearby pedestrian is detected in front of the vehicle.

See *Front Pedestrian Braking (FPB) System*
⇨ 202.

Traction Off Light



This light comes on briefly when the vehicle is turned on to show that the light is working. If it does not come on then, have it fixed so it will be ready to warn you if there is a problem.

The traction off light comes on when the Traction Control System (TCS) has been turned off. If StabiliTrak/Electronic Stability Control (ESC) is turned off, TCS is also turned off. To turn TCS and ESC off and on, see *Traction Control/Electronic Stability Control* ⇨ 170.

If TCS is off, wheel slip during acceleration is not limited unless necessary to help protect the driveline from damage. Adjust driving accordingly.

Traction Control System (TCS)/ Electronic Stability Control Light



This light comes on briefly when the vehicle is turned on to show that the light is working. If it does not come on then, have it fixed so it will be ready to warn you if there is a problem.

If the light is on and not flashing, the TCS and potentially the StabiliTrak/ESC system are not fully operational and may not assist in maintaining control. Adjust driving accordingly. If the condition persists, see your Cadillac Service Centre as soon as possible. A Driver Information Centre (DIC) message may display.

The light flashes when the TCS and/or the StabiliTrak/ESC system is actively working.

See *Traction Control/Electronic Stability Control* ⇨ 170.

Electronic Stability Control (ESC) Off Light



This light comes on briefly when the vehicle is turned on to show that the light is working. If it does not come on then, have it fixed so it will be ready to warn you if there is a problem.

This light illuminates when the StabiliTrak/Electronic Stability Control (ESC) system is turned off. If StabiliTrak/ESC is off, the Traction Control System (TCS) is also off. To turn ESC off and on, see *Traction Control/Electronic Stability Control* ⇨ 170.

If ESC and TCS are off, the systems do not assist in controlling the vehicle. Adjust driving accordingly.

Driver Mode Control Light



This light comes on when Tour Mode is selected.



This light comes on when Sport Mode is selected.



This light comes on when Snow/Ice Mode is selected.



This light comes on when My Mode is selected.

See *Driver Mode Control* ⇨ 171.

Tyre Pressure Light



If equipped with the Tyre Pressure Monitor System (TPMS), this light comes on briefly when the vehicle is started. It provides information about tyre pressures and the TPMS.

When the Light Is On Steady

This indicates that one or more of the tyres are significantly underinflated.

A Driver Information Centre (DIC) tyre pressure message may also display. Stop as soon as possible, and inflate the tyres to the pressure value shown on the Tyre and Loading Information label. See *Tyre Pressure* ⇨ 265.

When the Light Flashes First and Then Is On Steady

If the light flashes for about a minute and then stays on, there may be a problem with the TPMS. If the problem is not corrected, the light will come on every time the vehicle is started. See *Tyre Pressure Monitor Operation* ⇨ 268.

Security Light



The security light should come on briefly as the vehicle is started. If it does not come on, have the vehicle serviced by your Cadillac Service Centre. If the system is working normally, the indicator light turns off.

If the light stays on and the vehicle does not start, there could be a problem with the theft-deterrent system. See *Immobiliser Operation* ⇨ 25.

Vehicle Ready Light



The vehicle ready light comes on whenever the vehicle is ready to be driven.

Main-Beam On Light



This light comes on when the high-beam headlamps are in use.

See *Headlamp Main/Dipped-Beam Changer* ⇨ 114.

See *Exterior Lamp Controls* ⇨ 113.

Automatic Main-Beam Light



If equipped, this light comes on when the IntelliBeam system or Adaptive Headlight system is enabled.

See *Exterior Lamp Controls* ⇨ 113.

Adaptive Forward Lighting (AFL) Light



The light may come on briefly as the vehicle is started to indicate that a change to the left hand traffic and right hand traffic selection has occurred during the last operating cycle.

This light flashes when the system is switching between left hand traffic and right hand traffic.

If equipped, this light comes on solid when there is a problem with the AFL system or Adaptive Headlight system.

See *Adaptive Forward Lighting (AFL)* ⇨ 115.

See *Exterior Lamp Controls* ⇨ 113.

Rear Fog Lamp Light



This light comes on when the rear fog lights are on.

The light goes out when the fog lamps are turned off. See *Rear Fog Lamps* ⇨ 118.

Lamps On Reminder



This light illuminates when the exterior lamps are in use, except when only the Daytime Running Lamps (DRL) are active. See *Exterior Lamp Controls* ⇨ 113.

Cruise Control Light



The cruise control light is white when the cruise control is on and ready, and turns green when the cruise control is set and active.

Adaptive Cruise Control Light



This light is white when the Adaptive Cruise Control (ACC) is on and ready, and turns green when the ACC is set and active.

See *Adaptive Cruise Control (Advanced)* ⇨ 173.

Driver Attention Assist Light



If equipped, the Driver Attention Assist Light may display amber when:

- Drowsiness assistance is not available
- Driver Attention Assist has been disabled
- Driver Attention Assist system requires service

Driver Attention Assist will display messages in the Driver Information Centre (DIC). See *Driver Attention Assist* ⇨ 208.

Door Ajar Light



This light comes on when a door is open or not securely latched. Before driving, check that all doors are properly closed.

Information Displays

Charging

Important Information about Electric Vehicle Charging

- Charging an electric vehicle and increased charging rates can stress a building's electrical system more than a typical household appliance.
- Before plugging the charging cable into an electrical socket for the first time, have a qualified electrician inspect and verify the electrical system (electrical socket,

wiring, junctions, and protection devices) for heavy-duty service at a 12 amp continuous load.

- Check electrical sockets often, as they may wear out with normal use or become damaged over time, making them unsuitable for electric vehicle charging.
- Check the electrical socket/plug while charging. If the electrical socket/plug appears hot, discontinue using it immediately and have the electrical socket serviced by a qualified electrician.
- When charging outdoors, use an electrical socket that is weatherproof.
- Mount the charging cord to reduce strain on the electrical outlet/plug.
- Do not place the charging cable in a position where there is risk of it being submerged in water.

Danger

Improper use of portable electric vehicle charge cords may cause a fire, electrical shock, or burns, and may result in damage to property, serious injury, or death.

(Continued)

Danger (Continued)

- Do not use extension cables, multi-socket power strips, splitters, earthing adapters, surge protectors, or similar devices.
- Do not use an electrical socket that is worn or damaged, or will not hold the plug firmly in place.
- Do not use an electrical outlet that is not properly grounded.
- Do not use an electrical outlet that is on a circuit with other electrical loads.

Charging App

The Charging app provides access to features which help you to review and manage charging preferences.

To launch the Charging app from the infotainment home screen, select the Charging icon. There are three selections to choose from: Next Charge, Schedule, and Settings. When you launch Charging for the first time, the Next Charge screen will display.

Next Charge

To view the current charging status in the infotainment screen, select .

On the Next Charge screen, you can review information for the next charging session and specify if you want to Charge Now or Charge Later.

Charge Now

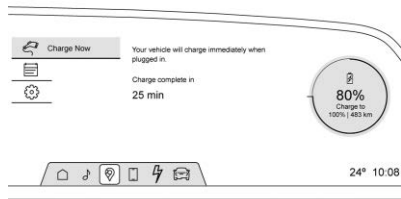

Charge Now is the default charging mode for your vehicle. The vehicle begins charging immediately when it is plugged in and authenticated at the charging location.

With Charge Now selected, the screen displays:

- Text indicating that the vehicle will charge immediately when plugged in.
- The estimated time at which the vehicle will reach the desired charge level.



- **Target Charge Level Gauge:**
The percentage at which the vehicle will stop charging. The gauge also displays an estimate of the vehicle's range upon completing the charging session.

 **Warning**

Do not charge your vehicle's battery above an 80% charge if you are going to drive down long, steep gradients such as mountain passes. This provides room in the battery for regenerative braking to supplement your conventional brakes during the descent. This is especially important when towing a trailer, which puts additional stress on your vehicle's braking system.

See *Hill and Mountain Roads* ⇨ 154 for important information about driving on gradients.

The default charge level is 80% when plugged in to protect battery life. To set a different charge level, drag the circular marker on the Target Charge Level Gauge to the preferred value. To lower the desired charge level, drag the Charge Level marker anticlockwise, and to increase it drag the marker clockwise. The charge level can also

be changed by selecting  and  inside the gauge on the screen. The Multi-Function Controller (MFC) on the centre console can also be used to set the charge level by rotating it clockwise or anticlockwise when the Target Charge Level Gauge is highlighted. The range estimate updates once the desired charge level is set. To optimise battery health, the minimum allowable charge level is determined by the vehicle.

Charge Later

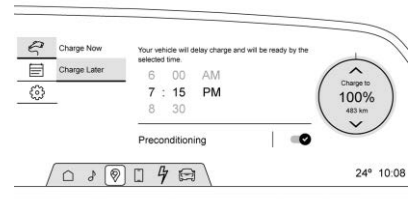

Instead of charging immediately to a desired charge level, you may choose to delay the charge to the vehicle and have it completed by your desired departure time. This may be a more economical choice and a more efficient use of energy when charging at home. To use this mode, touch Charge Later on the Next Charge screen.

With Charge Later selected, the screen displays:

- Text indicating that your vehicle will delay charging to be ready by the time specified.
- The ability to set the desired time at which the vehicle will finish charging and be ready for departure.
- Target Charge Level Gauge: Ability to set the percentage at which the vehicle will stop charging. The gauge also displays an estimate of the vehicle's range upon completing the charging session.
- Preconditioning: Ability to heat or cool the cabin to your desired temperature using energy from the charger. Energy from the battery is not used to condition the cabin, ensuring the vehicle gets the maximum range from the charging session. Preconditioning happens at the end of the charge, and right before the departure time.

To set the time at which the vehicle will complete the charge and be ready for departure:

Drag each value up or down within the time selector until the preferred time is selected. The time selector can also be modified using the MFC on the centre console by turning

the knob when the preferred value is highlighted. If the desired charge level cannot be reached by the selected time, a message will display that one of the two preferences must be adjusted.

To adjust the desired charge level in Charge Later mode, see “Charge Now” earlier in this section.

Setting the Preconditioning preference:

Touch the switch to turn on Preconditioning. The Preconditioning temperature can be adjusted by selecting Preconditioning on this screen, or in Settings.

Active Charging



During an active charging session, the Charging screen displays and continuously updates the following items:

- The current charging status.

- The range the vehicle is capable of driving at the current charge level.
- Range accumulation per hour of charging.
- The estimated time at which the vehicle will reach the desired charge level.
- Target Charge Level Gauge: The current charge level value represented as a percentage and a coloured section of the circular gauge.

To update the desired charge level for the active charging session, drag the marker on the Target Charge Level Gauge.

Selecting the Stop Charge button at any time ends the active charging session. For information on beginning a charging session, see *Plug-In Charging* ⇨ 212.

For AC Standard Power chargers, you can also select the appropriate Charging Cable Limit for your location. This determines how much current can flow from an electrical socket to the vehicle battery. It also ensures proper charge time estimates.

When the charging cable limit is changed to the highest setting on an AC Standard Power circuit a notification is displayed.

If no Home Charge Location is set, the AC Standard Charging Cable limit will revert to the lowest setting every time the vehicle is shifted out of (P) Park.

Range and charge time estimates fluctuate depending on a number of factors such as charging cable level/limit, battery temperature, and outside air temperature. To learn more about the vehicle battery see *Plug-In Charging* ⇨ 212.

The peek-in charging screen can be used to monitor your vehicle's charge status when the vehicle is off, see *Instrument Cluster* ⇨ 87. To monitor the charging status remotely, download the myCadillac app on your mobile device.

Fast Charging

If equipped, the vehicle will immediately begin charging when plugged into a fast charge station. While fast charging, the vehicle will bypass any schedule or departure time selection. See *Plug-In Charging* ⇨ 212.

Schedule

Select  to schedule a custom charging plan for each day of the week. When the vehicle is plugged in at the Home Charge

Location, the Schedule feature will automatically charge to the desired charge level and precondition the cabin by the time set in the Schedule. This feature acts as a more customisable Charge Later setting than the one on the Next Charge screen.

Creating a Schedule

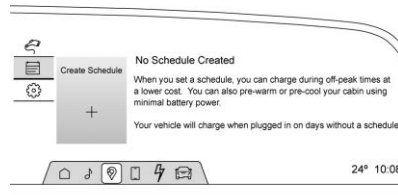

To create a schedule, touch Create Schedule. If there is no Home Charge Location set, you will be prompted to create one.

The Charging Schedule screen displays:

- Days of the week.
- A value selector for setting the desired charge level.
- A time selector for setting the time the vehicle will reach the desired charge level.

- Preconditioning: Allows the vehicle to heat or cool the cabin to the desired temperature by using energy from the charger.
- An X allowing you to close the Charging Schedule screen.
- Save & Close button: Applies any changes made and exits the dialogue.

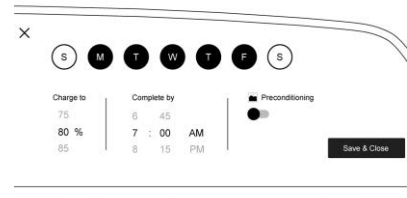

Days can be assigned to the schedule. Days of the week are represented in toggles containing their first letter. Touching each day illuminates the graphic, confirming that day is assigned that to the schedule. Touching a second time unassigns days from this schedule, dimming the toggle once again. Select all days you wish to adhere to the settings in this schedule. If there are multiple charge schedules, days must be unassigned from their current schedule before they can be assigned to a new one.

Once completed with the charging schedule, select the Save & Close button to finish creating the schedule.

On days that are not assigned a schedule, the vehicle will begin charging to 80% as soon as it is plugged in, unless otherwise specified on the Next Charge screen.

Home Charge Schedule can be turned ON or OFF. To enable or disable all charging schedules, select the toggle switch next to Home Charge Schedule on the Schedule screen.

Modifying and Deleting Charge Schedules

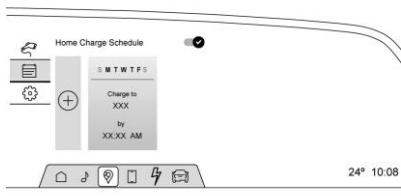

To modify a schedule, select the card on the Schedule screen. This will open a screen. Make the desired changes and select the Save & Close button when finished. To

delete the schedule, select the Delete Schedule button and confirm your decision when prompted.

Charge Settings

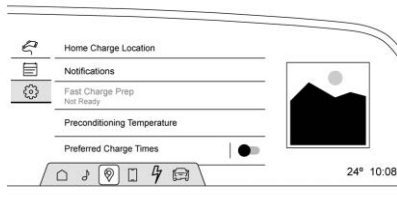

To view and change the Charge Settings, select .

Use this screen to set vehicle charging preferences. Touching any item will display options for specifying their behaviour.

The Settings screen displays:

Home Charge Location

With a Home Charge Location set, the vehicle can determine whether it is plugged in at home and will charge according to any existing schedules. The Home Charge Location can be changed or deleted at this screen.

Wireless service and GPS satellite technologies must be available and operating for features to function properly. These systems may not operate if the battery is disconnected, or if the vehicle has been off for an extended period. If GPS is unavailable, a message displays on the infotainment screen. GPS functionality may resume after the next time you drive the vehicle.

Notifications

This section contains on/off preferences for multiple notifications triggered during the charging session.

Charge Status Feedback : When on, your vehicle will chirp to accompany changes in the charging status.

Charging Cable Unplugged Alert : When on and your vehicle is locked, the horn will sound and the headlights will flash if the charging cable becomes unplugged.

Charge Power Loss Alert : When on, your vehicle will chirp for an extended period if charging power is cut off.

Fast Charge Prep

If equipped, adjusts the battery to the optimal temperature for quicker Fast Charging. This should be done before charging at a Fast Charger.

Depending on the outside and battery temperature, battery conditioning could take longer to reach the optimal temperature.

When using Google Maps, the Fast Charge Prep feature begins automatically when a Fast Charge station is added to your route via the  on the infotainment screen.

Preconditioning Temperature

Allows you to set the preferred cabin temperature. During a planned charging session at the Home Charge Location, the vehicle cabin is warmed or cooled to this temperature if set to ON in either the Charge Later screen, or in an active Schedule.

Preferred Charge Times

Allows you to enable preferred charge time windows for the Home Charge Location during both weekday and weekend planned charging sessions. It does so whether the vehicle is set to Charge Later or observing a scheduled charge. This allows for charging at

a lower cost by prioritising charging during the electrical provider's off-peak period. The vehicle will use these times to reach the desired charge level by the scheduled time. If the vehicle cannot reach the desired charge level within these times, it will charge as needed outside of this time window.

Driver Information Centre (DIC)

The DIC is displayed in the instrument cluster. It shows the status of many vehicle systems.

DIC information is broken down into three main zones:

Control Panel : A touchscreen display to left of the instrument cluster.

Left Zone : Displays on the instrument cluster to the left of the speedometer.

Right Zone : Displays on the instrument cluster to the right of the speedometer.

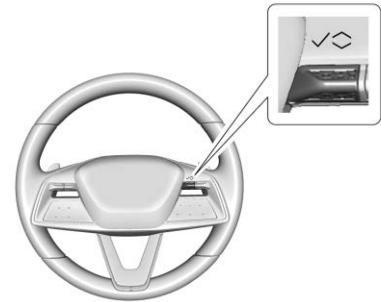

∧ or ∨ : Use to scroll to the previous or next selection.

✓ : Press to open a menu or select a menu item. Press and hold to reset certain displays.

DIC Information Display Options

Select which info display to view by selecting Add to Driver Display in the Vehicle Status on the infotainment display. See *Settings* ⇨ 137 or *Vehicle Status* ⇨ 106.

DIC Information Displays

The following is the list of all possible DIC information displays and their locations. Some of the information displays may not be available for your particular vehicle.

Control Panel

Trip 1 or Trip 2 and Average Efficiency : The Trip display shows the current distance travelled, in either kilometres (km) or miles (mi), since the trip odometer was last reset. To reset the current trip, touch and hold the touchscreen display when trip odometer is displayed.

The Average Efficiency shows the approximate average kWh per 100 kilometres (kWh/100 km), kilometres per kilowatt hour kWh (km/kWh), or miles per kilowatt hour kWh(mi/kWh). This number is calculated based on the number of kWh/100 km, km/kWh, or mi/kWh recorded since the last time this menu item was reset. This number only reflects the approximate average electrical energy economy that the vehicle has at that moment, and changes as driving conditions change.

Left Zone

Time/Date : Displays current date and time information. If equipped, Air Quality information is shown below date and time information. Air Quality shows the measured Particulate Matter (PM_{2.5}), along with the status of the air quality. This indicates how clean or polluted outdoor air is. Higher numbers indicate more pollutants and a greater potential for adverse health effects.

Tyres : Displays the approximate pressures of all four tyres. Tyre pressure is displayed in either kilopascal (kPa) or in pounds per square inch (psi). If the pressure is low, the value for that tyre is shown in amber. See *Tyre Pressure Monitor System* ⇨ 267 and *Tyre Pressure Monitor Operation* ⇨ 268.

If equipped, Tyre Temperature is located below the tyre pressure graphic. Tyre Temperature shows overall temperature as either Cold, Cool, Normal, Warm, or Hot. Normal is typical for normal driving while Warm is typical for spirited driving. Unknown displays when tyre temperature information is unavailable.

Energy Usage : Displays energy usage of the Driving, Remote Start, and Climate and Conditioning vehicle systems as percentages of overall vehicle energy use.

Energy Efficiency : Displays a graph showing the energy efficiency that has been used by the vehicle over a recently driven distance.

Driver Assistance : If equipped, shows information for Adaptive Cruise Control (ACC), Lane Keep Assist (LKA), and Forward Collision Alert (FCA).

Right Zone

Audio Now Playing : Displays the actively playing audio.

Navigation : Displays a variety of navigation information.

Phone : Displays a variety of call information.

Vehicle Status

The following are all possible vehicle status features.

To access the vehicle status menu touch  from the list of home page icons displayed on the left side of the infotainment display. Vehicle status content is shown on cards that are grouped together in option tabs that are displayed on the infotainment display.

Touching a card on the infotainment display opens up a dialogue box for that card. To select a desired option within a dialogue box, touch the option and follow any message or alerts that may display. Some options may be unavailable while driving.

Touch Add to Driver Display to send the desired card to the left zone of the instrument cluster. Touch Remove from Display to remove the selected card from the instrument cluster. See *Driver Information Centre (DIC)* ⇨ 105.

Options

The following is the list of all possible cards and their locations. Some of the cards may not be available for your particular vehicle.

Overview

Displays an interactive 3-D rendered image of your vehicle that shows performance and health information.

Tyres

Displays the approximate pressures of all four tyres. Tyre pressure is displayed in either kilopascal (kPa) or in pounds per square inch (psi). If the pressure is low, the

value for that tyre is shown in amber. See *Tyre Pressure Monitor System* ⇨ 267 and *Tyre Pressure Monitor Operation* ⇨ 268.

If equipped, Tyre Temperature is located below the tyre pressure graphic. Tyre Temperature shows overall temperature as either Cold, Cool, Normal, Warm, or Hot. Normal is typical for normal driving while Warm is typical for spirited driving. Unknown displays when tyre temperature information is unavailable.

When selected, the following options may be chosen in the dialogue: Relearn Tyre Pressure, Turn Off/On Leak Detection, Reset Leak Detection, and Add to Driver Display. When enabled, you will receive alerts when a fast and/or slow tyre leak is detected. The Leak Detection speeds shown are either Tyre Leak or Fast Leak. When disabled, you will still receive low tyre pressure alerts. However, you will stop receiving additional alerts when a tyre is leaking air.

Energy Info

Energy Usage : Displays how energy is being used for the current drive since the last time the vehicle was started. Percentages of the Driving, Remote Climate, and Climate and Prep vehicle systems as overall vehicle energy use are shown. When

selected, distance driven, total energy, energy usage bar diagram, and selectable categories are displayed. Select a category to learn more about how your vehicle uses energy from the battery.

When selected, Add to Driver Display may be chosen in the dialogue.

Energy Efficiency : Displays a graph showing the energy efficiency that has been used by the vehicle over a recently driven distance. When selected, regenerated range, and instant efficiency is shown along with average efficiency in the dialogue.

When selected, Add to Driver Display may be chosen in the dialogue.

Air Quality

Displays the measured Particulate Matter (PM2.5), along with the status of the air quality. This indicates how clean or polluted outdoor air is. Higher numbers indicate more pollutants and a greater potential for adverse health effects. When Air Quality Index numbers are high, close your vehicles windows and doors, set your climate system to Auto, and turn on air recirculation.

Air Quality Index displays all of the possible measurement ranges, along with the status that is attributed to those ranges.

When selected, the following options may be chosen in the dialogue: Air Quality Index, and Add to Driver Display.

Head-Up Display (HUD)

If equipped with HUD, certain vehicle information is projected through a lens on top of the instrument panel onto the windscreen.

If equipped with Dual Plane HUD, certain vehicle information will project centred over the road at the front of the vehicle in the far plane. The far plane is active when HUD is active.

Warning

If the HUD image is too bright or too high in your field of view, it may take you more time to see things you need to see when it is dark outside. Be sure to keep the HUD image dim and placed low in your field of view.

Caution

If you try to use the HUD image as a parking aid, you may misjudge the distance and damage your vehicle. Do not use the HUD image as a parking aid.

The HUD information can be displayed in various languages. The speedometer reading and other numerical values can be displayed in either English or metric units.

The language selection is changed through the radio and the units of measurement are changed through the instrument cluster. See *Settings* ⇨ 137.

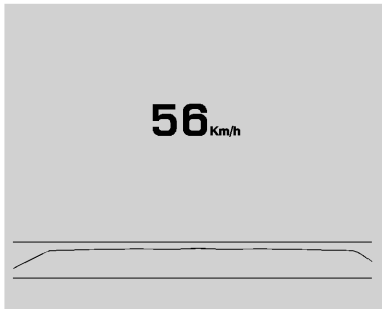

HUD Image

Depending on how the vehicle is equipped, the HUD may display the following vehicle information, messages, or alerts:

- Speed
- Audio
- Phone
- Navigation
- Driver Assistance Features
- Vehicle Messages

Some vehicle messages or alerts displayed in the HUD may be cleared by using the steering wheel controls.

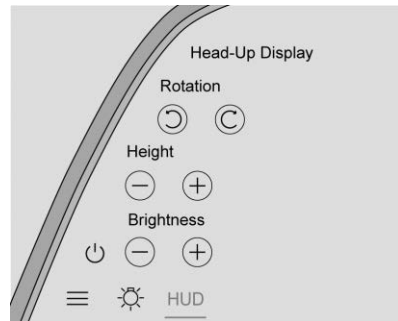

The HUD control is on a touchscreen to the left of the instrument cluster. HUD controls are also available on the infotainment screen. See *Settings* ⇨ 137.

To adjust the HUD image:

1. Adjust the driver seat.
2. Start the vehicle.
3. Select HUD on the touchscreen to the left of the instrument cluster.
4. Use the icons to adjust the HUD as desired.

The HUD image will automatically dim and brighten to compensate for outside lighting. Adjust as needed.

The HUD image can temporarily light up depending on the angle and position of sunlight on the HUD image. This is normal.

Polarised sunglasses can make the HUD image harder to see.

HUD Options

If equipped, this feature under the HUD Options menu on the infotainment screen allows you to adjust the HUD image. This feature may only be available in P (Park). See *Settings* ⇨ 137.

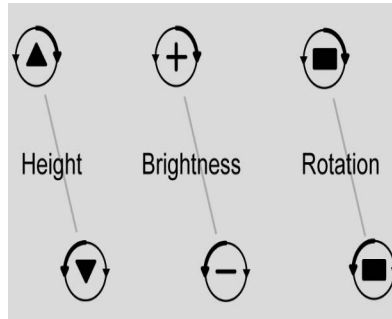

Press the icons above and below to adjust the HUD image.

Speed Limit Style Adjustment

If equipped, the speed limit style can be changed to a speed limit bar or speed limit sign from the Options menu in the instrument cluster. Press the thumbwheel while Speed Limit Style is highlighted to change the speed sign style or to turn it off.

HUD Views

There are three views in the HUD. Some vehicle information and vehicle messages or alerts are available in all views.

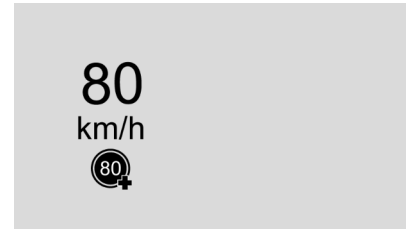

Speed View : If equipped, displays the speedometer reading in English or metric units and speed limit.

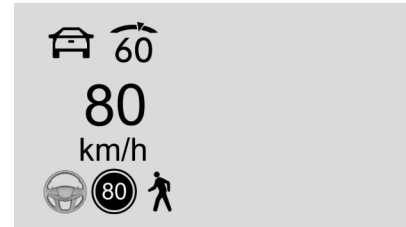

Active Safety View : Displays the speed view, pedestrian advisory, trailer sway, and a driver assistance graphic on the left. Driver assistance graphics show your vehicle, vehicle ahead, gap setting, and lane status information.



Navigation View : Displays the speed view and indicators for vehicle ahead, Lane Departure Warning/Lane Keep Assist, trailer sway, and pedestrian advisory. Turn-by-turn navigation information is shown during active route. The compass heading is displayed when navigation routing is not active.

Navigation turn-by-turn alerts shown in the instrument cluster may also be displayed in any HUD view.

Far Plane HUD

If equipped with Dual Plane HUD, the following alert images may appear in the far plane in any view. From highest to lowest priority:

1. Imminent Collision Alert triangle
2. Lane Change on Demand
3. Navigation directions at the manoeuvre

4. Navigation destination pin

Care of the HUD

Clean the inside of the windscreen to remove any dirt or film that could reduce the sharpness or clarity of the HUD image.

Clean the HUD lens with a soft cloth sprayed with glass cleaner. Wipe the lens gently, then dry it.

HUD Troubleshooting

If you cannot see the HUD image when the vehicle is on, ensure that:

- Nothing is covering the HUD lens.
- The HUD brightness setting is not too dim or too bright.
- The HUD is adjusted to the proper height and rotation.
- You are not wearing polarised sunglasses.
- The windscreen and HUD lens are clean.

If you continue to experience problems with the HUD, contact your Cadillac Service Centre.

The windscreen is part of the HUD system. See *Windscreen Replacement* ⇨ 252.

Vehicle Messages

Messages displayed on the Driver Information Centre (DIC) indicate the status of the vehicle or some action that may be needed to correct a condition. Multiple messages may appear one after another.

Vehicle status notifications are also sent to the infotainment display. Touching  on the bottom right corner of the infotainment display opens the notification drawer where all the active vehicle messages can be viewed. Depending on the message, you can schedule a service, find the nearest Cadillac Service Centre, or find the nearest charging station. When there are active messages that can be viewed, a red dot appears on top of the notification icon on the infotainment display.

The messages that do not require immediate action can be acknowledged and cleared by pressing the thumbwheel. The messages that require immediate action cannot be cleared until that action is performed.

All messages should be taken seriously; clearing the message does not correct the problem.

If a SERVICE message appears, see your Cadillac Service Centre.

Follow the instructions given in the messages. The system displays messages regarding the following topics:

- Service Messages
- Fluid Levels
- Vehicle Security
- Brakes
- Ride Control Systems
- Advanced Driver Assistance Systems
- Cruise Control
- Lighting and Bulb Replacement
- Wiper/Washer Systems
- Doors and Windows
- Seat Belts
- Airbag Systems
- Propulsion
- Tyre Pressure
- Battery
- Steering

Propulsion Power Messages

REDUCED ACCELERATION DRIVE WITH CARE

This message displays when the vehicle's propulsion power is reduced. A reduction in propulsion power can affect the vehicle's ability to accelerate. If this message is on, but there is no observed reduction in performance, proceed to your destination. Under certain conditions, the performance may be reduced the next time the vehicle is driven. The vehicle may be driven while this message is on, but maximum acceleration and speed may be reduced. Anytime this message stays on, or displays repeatedly, the vehicle should be taken to your Cadillac Service Centre for service as soon as possible.

This message can be displayed when the high voltage battery charge level is low. This is normal behaviour as the vehicle is limiting power due to reduced battery capability.

Under certain operating conditions propulsion will be disabled. Try restarting after the vehicle has been off for two minutes.

PROPULSION POWER REDUCED DUE TO TEMPERATURE

This message displays when the vehicle is on, the battery temperature is low, and when the vehicle's performance is limited. The duration of the limited vehicle performance depends, in part, on the high voltage battery charge level. If the high voltage battery charge level is relatively high, as the vehicle is driven, the battery temperature will increase, and the vehicle will return to normal operation. If the high voltage battery charge level is relatively low the vehicle will not return to normal operation until charged.

Keep the vehicle plugged in, even when fully charged, to keep the high voltage battery temperature ready for the next drive. This is important when outside temperatures are extremely hot or cold.

Vehicle Speed Messages

SPEED LIMITED TO XXX KM/H (MPH)

This message shows that the vehicle speed has been limited to the speed displayed. The limited speed is a protection for various propulsion and vehicle systems, such as lubrication, thermal, brakes, suspension, Teen Driver if equipped, or tires.

Lighting

Exterior Lighting

Exterior Lamp Controls	113
Exterior Lamps Off Reminder	114
Headlamp Main/Dipped-Beam Changer	114
Flash-to-Pass	114
Daytime Running Lamps (DRL)	114
Automatic Headlamp System	115
Adaptive Forward Lighting (AFL)	115
Headlamp Levelling Control	117
Hazard Lights	117
Turn and Lane-Change Signals	117
Rear Fog Lamps	118
Cornering Lights	118

Interior Lighting

Instrument Panel Illumination Control	118
Dome Lamps	119
Reading Lamps	119

Lighting Features

Entry Lighting	119
Exit Lighting	120
Battery Load Management	120
Battery Power Protection	120
Exterior Lighting Battery Saver	120

Exterior Lighting

Exterior Lamp Controls

The exterior lamp controls, also known as headlights, are in the Controls App on the infotainment home screen. Select Controls > Lights > Headlights.

To operate, select the following options:

Off : Turns off the exterior lamps.

For vehicles first sold in Canada, the headlights will automatically reactivate when the vehicle is shifted out of P (Park).

Auto : Automatically turns on the headlights, parking lights, tail lights, instrument panel lights, roof marker lights (if equipped), number plate lights, or Daytime Running Lights (DRL), depending on outside lighting.

Parking : Turns on the parking lights.

On : Turns on the headlights and parking lights.

IntelliBeam System

If equipped, this system turns the main-beam headlights on and off according to surrounding traffic conditions.

The system turns the main beam headlamps on when it is dark enough and there is no other traffic present.

This light  appears on the instrument cluster when the IntelliBeam system is enabled.

Do not use the IntelliBeam in dense exhaust, smoke, fog, road spray, mist, or other airborne obstructions.

Turning the IntelliBeam On and Off

To enable and disable the IntelliBeam system on the infotainment home screen, select Control App > Lights >  Auto Main Beams On. The headlights must be set to On.

Driving with IntelliBeam

The system only activates the main beams when driving over 40 km/h (25 mph).

The blue main-beam on light appears on the instrument cluster when the main beams are on.

There is a sensor near the top centre of the windscreen that automatically controls the system. Keep this area of the windscreen clear of debris to allow for best system performance.

The main beam headlamps remain on, under the automatic control, until one of the following situations occurs:

- The vehicle speed drops below 20 km/h (12 mph).
- The fog lights are turned On, if equipped.
- The system detects an approaching vehicle's headlamps.
- The system detects a preceding vehicle's tail lamps.
- The outside light is bright enough that main beam headlamps are not required.

The IntelliBeam system can be disabled by manually selecting the main-beams or flash to pass. If this happens, re-enable the IntelliBeam system as described above or select the re-enable icon on infotainment screen. The instrument cluster light will come on to indicate the IntelliBeam system is reactivated.

The main beams may not turn off automatically if the system cannot detect another vehicle's lamps because of any of the following:

- The other vehicle's lamps are missing, damaged, obstructed from view, or otherwise undetected.

- The other vehicle's lamps are covered with dirt, snow, and/or road spray.
- The other vehicle's lamps cannot be detected due to dense exhaust, smoke, fog, snow, road spray, mist, or other airborne obstructions.
- The vehicle windshield is dirty, cracked, or obstructed by something that blocks the view of the light sensor.
- The vehicle is loaded such that the front end points upward, causing the light sensor to aim high and not detect headlamps and tail lamps.
- The vehicle is being driven on winding or hilly roads.

The automatic main beam headlights may need to be disabled if any of the above conditions exist.

Exterior Lamps Off Reminder

A warning chime sounds if the driver door is opened while the vehicle is off and the exterior lights are on.

Headlamp Main/Dipped-Beam Changer

Push the indicator lever away from you and release, to turn the main beams on. To return to dipped beams, push the stalk again or pull it toward you and release.



This indicator light turns on in the instrument cluster when the high-beam headlamps are on.

Flash-to-Pass

To flash the main beams, pull the indicator stalk toward you, and release.

Daytime Running Lamps (DRL)



DRL can make it easier for others to see the front of your vehicle during the day.

The DRL come on when all of the following conditions are met:

- The vehicle is on.
- The exterior lamp control is in AUTO.

- The light sensor determines it is daytime.

The tail lights, instrument panel lights, and other lights will not turn on when this feature is activated.

To turn off the DRL, turn the exterior lamp control to  or .

Automatic Headlamp System

When the exterior lamp control is set to Auto and it is dark enough outside, the headlights come on automatically.



There is a light sensor on top of the instrument panel. Do not cover the sensor.

The system may also turn on the headlamps when driving through a parking garage or tunnel.

If the vehicle is started in a dark garage, the automatic headlamp system comes on immediately. If it is light outside when the vehicle leaves the garage, there is a slight delay before the automatic headlight system changes to the Daytime Running Lamps (DRL). During that delay, the instrument cluster may not be as bright as usual. Make sure the instrument panel brightness control is in the full bright position. See *Instrument Panel Illumination Control* ⇨ 118.

When it is bright enough outside, the headlights will turn off or may change to DRL.

The automatic headlight system turns off when the exterior lamp control is set to On or the vehicle is off.

Lamps On with Wipers

If the windshield wipers are activated in daylight with the vehicle on and the exterior lamp control is set to Auto, the headlights, parking lights, and other exterior lamps come on. The transition time for the lamps coming on varies based on wiper speed.

When the wipers are not operating, these lamps turn off. Set the exterior lamp control to On or Off to disable this feature.

Adaptive Forward Lighting (AFL)

If equipped with the AFL system, the main-beam headlights move horizontally while turning the steering wheel to provide greater road illumination around bends.

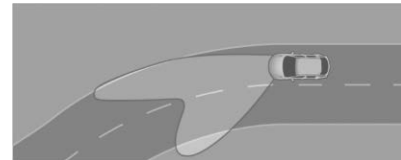

To activate AFL, set the exterior lamp control to the Auto position. See *Exterior Lamp Controls* ⇨ 113.

To adjust the AFL setting, go to the infotainment home screen and select Settings > Vehicle > Lighting.

Moving the exterior lamp controls out of the Auto position will deactivate the system. The main-beam headlights can move horizontally when the vehicle speed is greater than 3 km/h (2 mph). Headlights will not move horizontally when the electric drive unit is in R (Reverse).

If equipped, the AFL system automatically modifies the dipped-beam lighting patterns to the situation to enable optimal light performance for the driver. Light distribution and intensity of dipped-beam light are controlled based on exterior lighting conditions, vehicle location, and driving situations.

Town Light

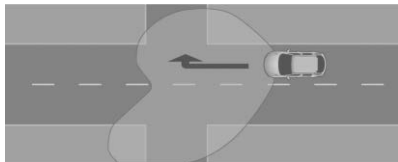

If equipped, the town light activates automatically at a speed greater than 30 km/h (18 mph) up to 55 km/h (34 mph) while driving within a city.

The light is wide and symmetrical. The special beam pattern is designed to prevent glare for other road users.

Country Light

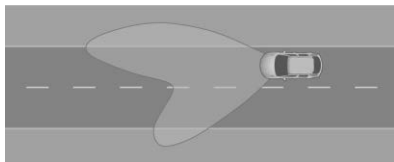

If equipped, the country light activates automatically at a speed above 55 km/h (34 mph).

The illumination of the current lane and the side of the road is improved, reducing glare to oncoming and preceding vehicles.

Freeway/Motorway Light



If equipped, when driving faster than 90 km/h (55 mph) on freeways, the dipped-beam illumination is smaller and extended.

Adverse Weather Light

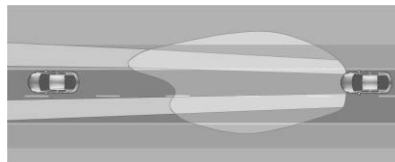

If equipped, the adverse weather light activates automatically when driving in adverse weather conditions (heavy rain, snow, sleet, freezing rain, etc.).

The illumination is shifted more to the side of the road to highlight road signs, and reduces glare caused by reflecting of wet roads.

Manoeuvring Light

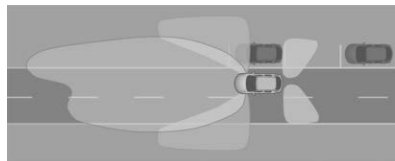

If equipped, the manoeuvring light activates automatically at speeds less than 7 km/h (4 mph) when the vehicle is in R (Reverse). The manoeuvring light illumination improves parking and manoeuvring situations.

Headlamp Levelling Control

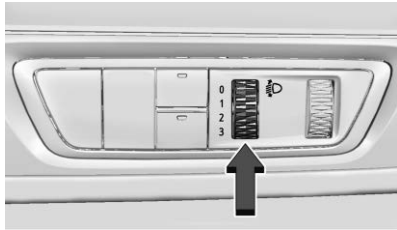

Manual Headlight Levelling

If equipped, the manual headlight levelling control knob is near the exterior lamp control. Use the control knob to adjust the headlight level to suit the vehicle load. Correct adjustment of the headlamp level can reduce the glare for other drivers.

The dipped beam headlamps must be on to adjust the headlamp level.

 : Turn the knob up or down to adjust the headlights.

- 0 = Driver with a passenger seat occupied
- 1 = Driver with all passenger seats occupied
- 2 = Driver seat occupied and a full load in the luggage compartment

- 3 = Driver with all passenger seats occupied and load in the luggage compartment

Automatic Headlamp Levelling

If equipped, the level of the headlights is adjusted automatically based on the vehicle load.

Headlamp aim is important to safe driving. If the headlights require aiming or the automatic headlight levelling system is malfunctioning, see your Cadillac Service Centre for service.

Hazard Lights



 : Press this button on the overhead console to make the front and rear indicator lamps flash on and off. This warns others that you are having trouble. Press again to turn the flashers off.

The indicators do not work while the hazard warning flashers are on.

The hazard warning flashers turn on automatically if the airbags deploy.

Turn and Lane-Change Signals

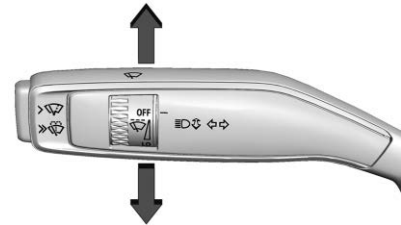

Move the lever all the way up or down to signal a turn.

An arrow on the instrument cluster will flash in the direction of the turn or lane change.

Raise or lower the lever until the arrow starts to flash to signal a lane change. Hold it there until the lane change is complete.

If the lever is moved momentarily to the lane change position, the arrow will flash three times. It will flash six times if Tow/Haul mode is active.

The stalk returns to its starting position when it is released.

If after signalling a turn or lane change, the arrow flashes rapidly or does not come on, a signal LED may be burned out.

See your Cadillac Service Centre for service. If a LED is not burned out, check the fuse. See *Instrument Panel Fuse Block* ⇨ 260.

Rear Fog Lamps

The Rear Fog Lights control is in the Controls App on the infotainment home screen under exterior lighting.

To operate, select the following option:

☞ : Press to turn on or off. An indicator light on the instrument cluster comes on when the fog lamps are on.

If the fog lights are turned on while the exterior lamp control is in the AUTO position, the lights come on automatically.

The vehicle and the parking lights or headlights must be on for the rear fog lights to work.

Some localities have laws that require the headlamps to be on along with the fog lamps.

Rear fog lamps should only be used in foggy or misty conditions to allow the drivers behind you to see your vehicle.

Cornering Lights

If equipped, cornering lamps automatically come on when all of the following occur:

- The dipped beam headlights are on.
- The indicators are activated or the steering wheel is at a turning angle.
- The vehicle speed is below 40 km/h (25 mph).

Interior Lighting

Instrument Panel Illumination Control



This feature adjusts the brightness of all illuminated controls.

☞ : Move the thumbwheel up or down to brighten or dim the lights.

The thumbwheel is functional at night, or when the headlights or parking lights are on.

The display brightness automatically adjusts based on outdoor lighting.

Stealth Mode

Stealth mode is only available at night. To enable Stealth mode, turn the thumbwheel to the OFF position.

In Stealth mode, all graphics will not be visible on the instrument cluster except coolant temperature, energy usage, digital speed, and any active tell-tales or alerts.

Dome Lamps

The dome lights automatically come on when any door is opened,  on the remote key is pressed, or when the vehicle is turned off.

The dome lights controls are in the Controls App on the infotainment home screen. Select Controls > Lights > Dome Lights.

 **Dome Light** : Select to manually turn the dome lights on or off.

Reading Lamps

There are reading lamps on the overhead console and over the rear seats. These lamps come on when any door is opened.



Front Reading Lamps

The front reading lamps are in the overhead console.

Press the light lens to turn the front reading lights on or off.

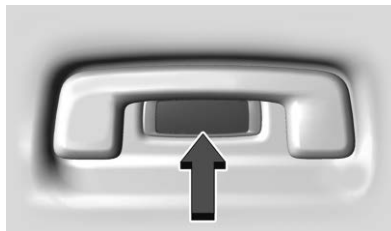

Rear Reading Lamps

The rear reading lamps are over the rear seats.

Press the lamp lens to turn the rear reading lamps on or off.

Lighting Features

Entry Lighting

The interior lights turn on when pressing  on the remote key or opening any doors, and the dome light control is in the door position.

Some exterior lamps also turn on when pressing  on the remote key or opening any doors. Dipped Beam lights will only turn on briefly at night, or in areas with limited lighting.

All lights will gradually dim after about 30 seconds.

Entry lighting can be disabled manually by closing all doors, pressing  on the remote key, or starting the vehicle.

This feature can be changed. On the infotainment home screen, select Settings > Vehicle > Lighting.

Approach Detection

If equipped, the entry lighting feature will automatically turn on when the remote key is detected within approximately 2 m (6 ft) of the vehicle.

If the vehicle has remained parked for an extended period of time with no remote key use or keyless access operation, approach detection will be disabled. To reactivate, press any button on the remote key or open and close all vehicle doors to re-enable the entry lighting feature on approach.

Exit Lighting

Some exterior lights and interior lights turn on when the driver door is opened after the vehicle is turned off.

The exterior and interior lights remain on for a set amount of time, then automatically turn off.

The interior lights turn on when the vehicle is turned off.

The exterior lamps turn off immediately by turning the exterior lamp control off.

This feature can be changed. On the infotainment home screen, select Settings > Vehicle > Lighting.

Battery Load Management

The vehicle has Electric Power Management (EPM) that estimates the battery temperature and state of charge. It then adjusts the voltage for best performance and extended life of the 12-volt battery.

When the battery state of charge is low, the voltage is raised slightly to quickly increase the charge. When the state of charge is high, the voltage is lowered slightly to prevent overcharging. As this adjustment occurs, you may see the voltage move up or down on the voltmeter gauge or voltage display on the Driver Information Centre (DIC), if equipped. This is normal. If a problem occurs, an alert will be displayed.

If the electrical loads are too high, the battery can be discharged when the vehicle is stationary. A high electrical load occurs when several features are on, such as: headlights, main beams, rear window demister, climate control fan at high speed, heated seats, motor cooling fans, trailer loads, and loads plugged into accessory power sockets.

EPM works to prevent excessive discharge of the battery by balancing the electrical system output and the vehicle's electrical

needs. In some cases, it can temporarily reduce the power demands of some accessories.

These actions occur in steps or levels without being noticeable. In rare cases at the highest levels of corrective action, this action may be noticeable to the driver. If so, a DIC battery voltage and charging message displays. It is recommended that the driver reduce the electrical loads as much as possible. See *Driver Information Centre (DIC)* ⇨ 105.



Battery Power Protection

This feature helps prevent the battery from being drained if the interior courtesy lights or reading lights are accidentally left on. If any of these lights are left on, they automatically turn off after 10 minutes when the vehicle is turned off. The lights will not come back on again until one of the following occurs:

- The vehicle is started.
- The doors are closed and then re-opened.

Exterior Lighting Battery Saver

The exterior lights turn off about 10 minutes after the vehicle is turned off, if the parking lights or headlights have been manually left

on. This protects against draining the battery. To restart the 10-minute timer, turn the exterior lamp control to the  position and then back to the  or  position.

To keep the lights on for more than 10 minutes, the vehicle must be on.

Infotainment System

Introduction

Introduction	122
Overview	123
Steering Wheel Controls	124
Using the System	124
Software Updates	126

Radio

AM-FM Radio	126
Digital Audio Broadcast (DAB) Radio ...	128
Radio Reception	129
Multi-Band Aerial	130

Audio Players

Avoiding Untrusted Media Devices	130
USB Port	130
Bluetooth Audio	130

Phone

Bluetooth (Overview)	131
Bluetooth (Pairing and Using a Phone)	131
Apple CarPlay and Android Auto	135

Settings

Settings	137
----------------	-----

Trademarks and Licence Agreements

Trademarks and Licence Agreements	138
--	-----

Introduction

Read the following pages to become familiar with the functions.

Warning

Taking your eyes off the road for too long or too often while using any infotainment feature can cause a crash. You or others could be injured or killed. Do not give extended attention to infotainment tasks while driving. Limit your glances at the vehicle displays and focus your attention on driving. Use voice commands whenever possible.

The infotainment system has built-in features intended to help avoid distraction by disabling some features when driving. These features may grey out when they are unavailable. Many infotainment features are also available through the instrument cluster and steering wheel controls.

Before driving:

- Become familiar with the operation, centre console controls, steering wheel controls, and infotainment display.

- Set up the audio by presetting favourite stations, setting the tone, and adjusting the speakers.
- Set up phone numbers in advance so they can be called easily by pressing a single control or by using a single voice command.

See *Distracted Driving* ⇨ 150.

Overview

Infotainment System

The Infotainment system is controlled by using the infotainment display, Multi-Function Controller (MFC) on the centre console, steering wheel controls, and voice recognition, if available.

Infotainment Controls on the Multi-Function Controller (MFC)

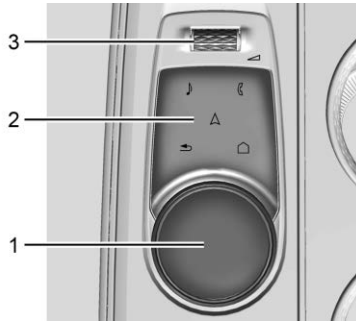

1. Primary Knob
 - Turn to highlight a feature. Press to activate the highlighted feature.
 - Move right/left or up/down to change the highlighted area on the display screen.
2. Selection Area
 - 🎵 (Radio/Audio)
Press to open the audio app page.
 - 📞 (Phone)
Press to access the phone menu.

3. ⏻ (Power/Volume) Scroll Wheel
 - Press to turn the power on.
 - Press and hold when the system is on to turn the power off.
 - Press to mute/unmute the system when on.
 - Scroll up or down to increase or decrease the volume.
- ⏴ (Navigation)
Press to access the navigation screen (if equipped).
 - ⏪ (Back)
Press to return to the previous display in a menu.
 - 🏠 (Home Page)
Press to access the Home Page. See “Home Page” later in this section.

Home Page

The Home Page is where vehicle application icons are accessed. Some applications are disabled when the vehicle is moving.

Swipe left or right across the display or use the MFC to move the home page. Move the knob right/left to change the page or touch

on one of the page count indicators at the bottom of the screen to jump to a specific page.

Managing Home Page Icons

1. Touch and hold any of the Home Page icons to enter edit mode. Edit mode is not available when the vehicle is moving.
2. Continue holding the icon and drag it to the desired position.
3. Release your finger to drop the icon in the desired position.
4. To move an application to another page, drag the icon to the edge of the display towards the desired page
5. Continue dragging and dropping application icons as desired.

There will always be 10 icons per page except on the last page. If an icon is moved from the first page to the second, then that icon from the second page will replace the one removed from the first.

Steering Wheel Controls

If equipped, some audio controls can be adjusted at the steering wheel.

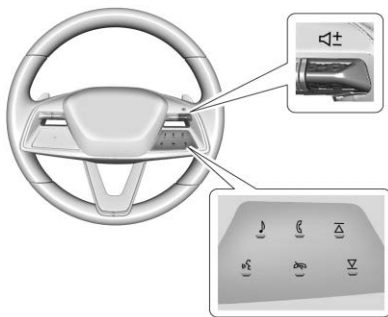

🔊 + or 🔊 - : Toggle up or down to increase or decrease the volume.

🎵 : Press show the audio sources list.

☎️ : Press to answer an incoming phone call or show the recent phone call list when not in a call.

⏪ or ⏩ : Press to go to the next or previous favourite when listening to the radio. Press to go to the next or previous track when listening to a media source.

🚫 : Press to reject an incoming phone call, end an active phone call, end a voice recognition session, or mute the audio when there is no phone call.

🗣️ : Press initiate voice assistant.

Using the System

Audio

Touch the Audio icon on the infotainment display or 🎵 on the Multifunction Controller (MFC) to display the active audio source page. Examples of available sources may include AM, FM, USB, and Bluetooth.

Phone

Touch the Phone icon on the infotainment display or ☎️ on the MFC to display the Phone menu. See *Bluetooth (Pairing and Using a Phone)* ⇨ 131 or *Bluetooth (Overview)* ⇨ 131.

Apple CarPlay

Touch the Apple CarPlay icon to activate Apple CarPlay (if equipped) after a supported device is connected. See *Apple CarPlay and Android Auto* ⇨ 135.

Android Auto

Touch the Android Auto icon to activate Android Auto (if equipped) after a supported device is connected. See *Apple CarPlay and Android Auto* ⇨ 135.

Settings

Touch the Settings icon to display the Settings menu. See *Settings* ⇨ 137.

Controls

Touch the Controls icon to display the Controls menu.

Application Tray

The Application Tray is along the bottom of the display. It shows up to six applications.

Infotainment Gestures

Use the following finger gestures to control the infotainment system.

Touch/Tap



Touch/tap is used to select an icon or option, activate an application or change the location inside a map.

Touch and Hold

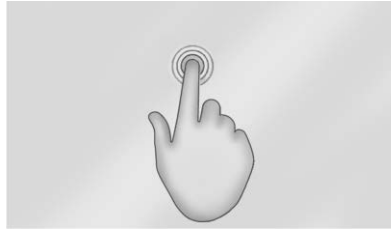

Touch and hold can be used to move or delete an application.

Drag

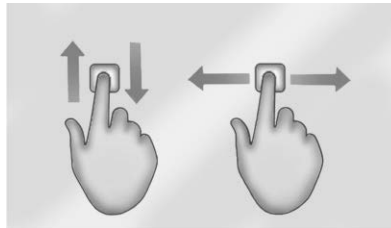

Drag is used to move applications on the Home Page, or to pan the map. To drag the item, it must be held and moved along the display to the new location. This can be

done up, down, right, or left. This function is only available when the vehicle is parked and not in motion.

Nudge



Nudge is used to move items a short distance on a list or a map. To nudge, hold and move the selected item up or down to a new location.

Fling or Swipe



Fling or swipe is used to scroll through a list, pan the map, or change page views. Do this by placing a finger on the display then moving it rapidly up and down or right and left.

Spread

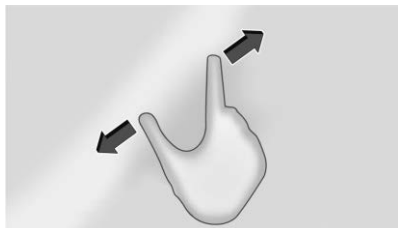

Spread is used to zoom in on a map, certain images, or a web page. Place finger and thumb together on the display, then move them apart.

Pinch

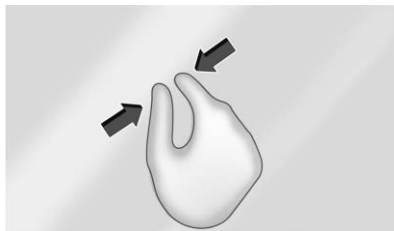

Pinch is used to zoom out on a map, certain images, or a web page. Place finger and thumb apart on the display, then move them together.

Cleaning High Gloss Surfaces or Vehicle and Radio Displays

For vehicles with high gloss surfaces or vehicle displays, use a microfibre cloth to wipe surfaces. Before wiping the surface with the microfibre cloth, remove dirt that could scratch the surface. Then use the microfibre cloth by gently rubbing to clean. Never use window cleaners or solvents. Periodically hand wash the microfibre cloth separately, using mild soap. Do not use bleach or fabric softener. Rinse thoroughly and air dry before next use.

Software Updates

Over-the-Air Software Updates

If equipped, see “Updates” under *Settings* ⇨ 137 for details on software updates.

Radio

AM-FM Radio

Playing the Radio

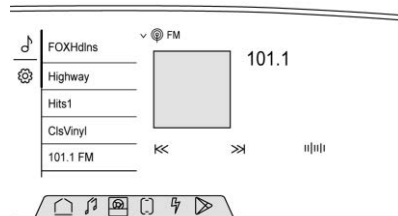

From the Home Page, touch the Audio icon to display the active audio source page.

Touch ∨ from the top of the page to choose from AM, FM, DAB, or Bluetooth.

Finding a Station

Seeking a Station

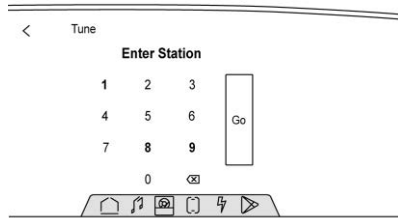

From the AM, FM, or DAB screen, touch << or >> on the infotainment display to search for the previous or next strong station.

Tune



Touch  on the infotainment display to display the Tune screen. Enter a station using the keypad.

The keypad will grey out entries that do not contribute to a valid frequency and will automatically place a decimal point within the frequency number.

Touch  to delete one number at a time. Touch and hold  to delete all numbers.

A valid AM, FM, or DAB station will automatically tune to the new frequency and display the now playing screen.

The list of all available stations are on the right side of the Tune display to browse. Touch to go to that station or touch  to save the station as a favourite.

Storing Radio Station Favourites

Favourites are shown in the area on the left of the display.

AM, FM, or DAB : Favourites can be stored by touching Hold to Set on the left side of the screen.

The number of favourites is displayed automatically.

Audio Settings

From the AM or FM screen, touch  to display the following:

Equalizer : Touch to adjust Bass, Midrange, or Treble using the options on the infotainment display.

Fade/Balance : Touch to adjust by using the controls on the infotainment display.

Sound Mode : Touch to select Front or Rear to provide the best sound for the front or rear seating positions.

Adjust the Surround controls to change from Stereo to Surround mode.

Adaptive Volume : Touch to turn On or Off.

Manage Radio Favourites : Touch to display a list of Audio favourites.

Favourites can be moved or deleted.

To move, touch and hold the move icon, and then drag up or down to rearrange the position.

Radio Text : This allows the Radio Data System (RDS) to be turned on or off.

Touch Off or On.

Radio Text Categories : When on, category information about current radio content will be shown.

Traffic Programme Alert (TP) : When on and the radio detects a traffic alert, a notification will be shown and an audio message will be heard.

Region : When on, radio settings will automatically adjust to your current region.

DAB Announcements : Allows you to choose which categories you would like to receive DAB Announcements for.

DAB-DAB Linking : When on and a DAB radio station's signal becomes weak, the radio can tune to the same station on a different DAB ensemble if it's available.

DAB-FM Linking : When on and a DAB radio station's signal becomes weak, the radio will try tuning to the station's FM variant. If DAB-DAB Linking is available, the radio will try linking to the station on another DAB ensemble first.

Radio Data System (RDS)

RDS relies on receiving specific RDS information from radio stations and only works when the information is available. It is possible that a radio station could broadcast information that causes the radio not to work properly.

In addition, RDS features are specific to region and country of sale. This means specific RDS content may not be available in your listening area or in the country you operate the vehicle.

To turn RDS features on or off, see "Audio Settings" previously.

The following core and region-specific RDS features may be supported by radio broadcasters in your listening area:

Core RDS features

- Display radio station call letters
- Display messages from radio stations
- Provide radio station category information (when available)

Region-specific RDS features

- Support Traffic Programme (TP) Alerts
- Support Alternate Frequency (AF) Switching
- Support Region Switching

Digital Audio Broadcast (DAB) Radio

If equipped, Digital Audio Broadcasting (DAB) Radio is a digital broadcast system that provides CD level audio quality along with supporting radio programme station information (e.g., station name, artist, song) on the infotainment display. Unlike AM/FM, the DAB signal is less likely to be impacted by interference during normal operation. However, the reception quality of DAB can be reduced if the signal is blocked by

natural obstacles or buildings. If the DAB signal is unclear, reception is interrupted completely.

Playing the Radio

From the Home screen, touch the Audio icon to display the Now Playing screen for the active audio source. Touch the source button such as DAB, AM, or FM to change the source.

Finding a Station

Seeking a Station

From the DAB screen, touch the back or forward buttons to search for the previous or next strong station.

Tune

Touch  on the infotainment display to enter the Tune screen. Enter a DAB station number using the alpha-numeric keypad (e.g., 5A).

Touch the  to save the station as a favourite.

After entering a valid DAB station, the radio will automatically tune to the new station but not close the Tune screen. Alternatively, touch the Go button or a DAB station in the

list to begin playing the station. The tune page will close and return to the Now Playing screen.

DAB Now Playing Screen

While tuned to a DAB station, your display may include relevant information such as station label, text information regarding artist and song, and a station logo. This information is provided by the DAB broadcaster and may not always be available in your listening region.

Storing DAB Radio Station Favourites

Saved favourite stations will show at the bottom of the Now Playing screen.

DAB favourites can be stored by pressing and holding a favourite slot while listening to that station.

DAB Linking

If equipped, your radio may support DAB to DAB Linking and DAB to FM Linking.

DAB to DAB Linking supports the automatic switching of your now playing DAB station to another DAB station with the same content. This happens if the Now Playing

DAB station reception weakens and a DAB station with the same content and better reception can be received.

DAB to FM Linking supports the automatic switching of your now playing DAB station to another station on the FM band with the same content. This happens if the Now Playing DAB station reception weakens and an alternate FM station with the same content and better reception can be received.

DAB linking settings can be turned on or off in the Settings menu.

DAB Announcements

If equipped, DAB announcements represent a grouping of broadcast announcements defined by category. Examples include news, emergency, weather, sports, finance etc. Desired announcement types can be selected by the user through the DAB Announcement screen. Emergency announcements are always enabled and cannot be disabled.

Selected announcements will be automatically received by the radio, when available. Your radio will provide a pop-up window to notify you that a pending

announcement will begin playing. You can choose to listen to or dismiss the announcement.

DAB announcement settings can be managed in the Audio Settings menu.

Radio Reception

Unplug electronic devices from the accessory power outlets if there is interference or static in the radio.

FM

FM signals only extend about 16 to 65 km (10 to 40 mi). Although the radio has a built-in electronic circuit that automatically works to reduce interference, some static can occur, especially around tall buildings or hills, causing the sound to fade in and out.

AM

The range for most AM stations is greater than for FM, especially at night. The longer range can cause station frequencies to interfere with each other. Static can also occur when things like storms and power lines interfere with radio reception. When this happens, try reducing the treble on the radio.

Digital Audio Broadcasting (DAB)

If equipped, Digital Audio Broadcasting (DAB) is a universal broadcast system that shows stations by the radio programme name on the infotainment display. The DAB signal produces a constant volume and is not affected by interference from nearby frequencies. The reception quality of DAB improves if the signal is reflected by natural obstacles or buildings. If the DAB signal is unclear, reception is interrupted completely.

Mobile Phone Usage

Mobile phone usage, such as making or receiving phone calls, charging, or just having the phone on may cause static interference in the radio. Unplug the phone or turn it off if this happens.

Multi-Band Aerial

The multi-band roof aerial may be used for radio, navigation, and other communication systems, depending on the equipped options. To ensure clear reception, keep the aerial clear of obstructions, such as snow and ice. If the vehicle has a sunroof, and it is open, or a roof loaded with cargo, reception may be affected.

Audio Players

Avoiding Untrusted Media Devices

When using media devices such as USB and mobile devices, consider the source. Untrusted media devices could contain files that affect system operation or performance and should be avoided.

USB Port

The vehicle may be equipped with multiple USB ports. Ports may also be used for charging. Music may be played from a connected USB device.

Caution
To avoid vehicle damage, unplug all accessories and disconnect all accessory cables from the vehicle when not in use. Accessory cables left plugged into the vehicle, unconnected to a device, could be damaged or cause a short circuit if the unconnected end comes in contact with liquid or another power source such as the accessory power outlet.

USB Audio

To play music via USB:

1. On the audio now playing page, touch source and select USB.
2. If there is no device connected, follow the screen prompts to connect the device.
3. Supported media content will appear on the display.

Bluetooth Audio

Music may be played from a paired Bluetooth device. See *Bluetooth (Pairing and Using a Phone)* ⇨ 131 or *Bluetooth (Overview)* ⇨ 131 for help pairing a device.

Volume and song selection may be controlled by using the infotainment controls or the mobile device. If Bluetooth is selected and no volume is present, check the volume setting on both your mobile device and the infotainment system.

Music can be launched by touching Bluetooth from the recent sources list on the left of the display or by touching the More option and then touching the Bluetooth device.

To play music via Bluetooth:

1. Power on the device, and pair to connect the device.
2. Once paired, touch Audio from the Home Page, then touch Source and touch the Bluetooth device.

Bluetooth Sound Menu

See “Infotainment System Sound Menu” under *AM-FM Radio* ⇨ 126.

Phone

Bluetooth (Overview)

The vehicle’s Bluetooth system can interact with a mobile device to:

- Place and receive calls in a hands-free mode.
- Share the device’s address book or contact list with the vehicle.
- Stream audio (music, podcasts).
- Notify receipt of text messages.

To minimise driver distraction, before driving and with the vehicle parked:

- Become familiar with the features of the mobile device. Organise the phone book and contact lists clearly and delete duplicate or unused entries.

- Review the controls and operation of the infotainment system.
- Pair mobile device(s) to the vehicle. The system may not work with all mobile devices. See “Pairing” later in this section.

Vehicles with a Bluetooth system can use a Bluetooth-capable mobile device with a Hands-Free Profile to make and receive phone calls. The infotainment system and voice recognition are used to control the system. The system can be used while the vehicle is on or in accessory mode. The range of the Bluetooth system can be up to 9.1 m (30 ft). Not all mobile devices support all functions and not all mobile devices work with the Bluetooth system. See your Cadillac Brand Ambassador for more information about compatible mobile devices.

Controls

Use the controls on the infotainment display and the steering wheel to operate the Bluetooth system.

Steering Wheel Controls

 : Press and release to answer incoming calls on your connected Bluetooth mobile device. Press and hold for mobile device assistant.

 : Press to end a call, decline a call, or cancel an operation. Press to mute or unmute the infotainment system when not on a call.

Infotainment System Controls

For information about how to navigate the menu system using the infotainment controls, see *Using the System* ⇨ 124.

Audio System

When using the Bluetooth system, sound comes through the vehicle’s front audio system speakers and overrides the audio system. The volume level while on a mobile device phone call can be adjusted by pressing the steering wheel volume controls or the volume controls for the infotainment system. The adjusted volume level remains the same for later calls. The volume cannot be lowered beyond a certain level.

Bluetooth (Pairing and Using a Phone)

Pairing

A Bluetooth-enabled mobile device must be paired to the Bluetooth system and then connected to the vehicle before it can be

used. See the mobile device manufacturer's user guide for Bluetooth functions before pairing the device.

Pairing Information

- Touch the phone icon on the infotainment home screen.
- If no mobile device has been paired, a message on the infotainment display will show the Manage Phones option. Touch this option and the Phones screen will display. See "Pairing a Phone" later in this section.
- A Bluetooth mobile device with music capability can be paired to the vehicle as a phone and a music player at the same time.
- Up to 10 devices can be paired to the Bluetooth system.
- The pairing process is disabled when the vehicle is moving.
- Pairing only needs to be completed once, unless the pairing information on the mobile device changes or the phone is deleted from the system.
- If a previously paired mobile device is not connecting to the Bluetooth system, try forgetting the mobile device on both the

vehicle's infotainment system and also on the mobile device. Then repeat the pairing process.

- If multiple paired mobile devices are within range of the system, the system connects to the paired mobile device that is set to First to Connect. If there is no mobile device set to First to Connect, it will connect to the mobile device which was used last. To connect to a different paired mobile device, see "Connecting to a Different Phone" later in this section.

Pairing a Phone

1. Make sure Bluetooth has been enabled on the phone before starting the pairing process.
2. Touch the phone icon on the infotainment home screen.
3. If a phone has been previously added, select Settings > Connections > Phones to reach the device manager. From the device manager, select "Add Phone".
If a phone has been previously added, the "Add Phone" card will just be a "+" card."

4. Touch Add Phone.

If a phone has been previously added or disconnected, the "Add Phone" card will just be a "+" card.

5. Follow the on-screen prompts to pair the phone.
6. Follow the instructions on the phone to confirm the six-digit code showing on the infotainment display and touch Pair. The code on the phone and infotainment display need to be acknowledged for pairing to be successful.
7. See the phone manufacturer's user guide for information on this process. Once the phone is paired, it will show as Connected.
8. If the vehicle name does not appear on your phone under the "other devices" or "available devices" menu, there are a few ways to start the pairing process over:
 - If a previously paired mobile device is not connecting to the Bluetooth system, try forgetting the mobile device on the vehicle's infotainment system and also forgetting the vehicle in the Bluetooth settings of the mobile device. Then repeating the pairing process. See "Deleting a Paired Phone" below for removing

the phone from the Bluetooth system. See the phone manufacturer's user guide for removing the infotainment system from the phone.

- Turn Bluetooth off then back on, on your phone.
 - Go back to the beginning of the Phone menus on the infotainment display and restart the pairing process.
 - Turn the phone off and then back on.
 - Reset the phone, but this step should be done as a last resort.
9. If the phone prompts to accept connection or allow phone book download, touch Always Accept and Allow. The phone book may not be available if not accepted.
10. To pair additional phones, touch Settings > Connections > Phones.

First to Connect Paired Phones

If multiple paired phones are within range of the system, the system connects to the paired phone that is set as First to Connect. To enable a paired phone as the First to Connect phone:

1. Make sure the phone is turned on.

2. Touch the Settings icon on the home page.
3. Touch Connections.
4. Touch Phone.
5. Touch Options under the connected phone.
6. Touch First to Connect from the phone's settings menu and set First to Connect to On.

Phones and mobile devices can be added, removed, connected, and disconnected. A sub-menu will display whenever a request is made to add or manage phones and mobile devices.

Accessing the Device List Screen

There are two ways to access the device list screen:

Using the Settings Icon

1. Touch the Settings icon on the infotainment home screen or the Settings icon on the shortcut tray near the left of the display.
2. Touch Connections.
3. Touch Phones.

Using the Phone Icon

1. Touch the Phone icon on the infotainment home screen or the Phone icon on the shortcut tray near the left of the display.
2. Touch  on the Phone screen.
3. Touch Connected Phone.

Disconnecting a Connected Phone

To disconnect a phone:

1. Open the Device List Screen. See "Accessing the Device List Screen" previously in this section.
2. Touch Option on the phone card to show the phone's or mobile device's settings.
3. Touch Disconnect.

Deleting a Paired Phone

To delete a paired phone:

1. Open the Device List Screen. See "Accessing the Device List Screen" previously in this section.
2. Touch Option on the phone card to show the phone's or mobile device's settings.
3. Touch Forget Phone.

Connecting to a Different Phone

To connect to a different phone, the new phone must be in the vehicle and paired to the Bluetooth system.

To connect to a different phone:

1. Open the Device List Screen. See “Accessing the Device List Screen” previously in this section.
2. Touch the new phone you want to connect to from the list of available phones. See “First to Connect Paired Phones” previously in this section.

Switching to Handset or Hands-Free Mode

To switch between handset or hands-free mode:

- While the active call is hands-free, touch the Audio Output option, then touch Phone to switch to the handset mode. The mute icon will not be available or functional while Handset mode is active.
- While the active call is on the handset, touch the Audio Output option, then touch Car Speakers to switch to the hands-free mode.

Making a Call Using Contacts

Calls can be made through the Bluetooth system using personal phone contact information for all phones that support the Phone Book feature. Become familiar with the phone settings and operation and make sure that the phone is set to allow the sharing of contacts over Bluetooth with the vehicle. Verify the phone supports this feature and that the phone is set to allow the sharing of contacts over Bluetooth with the vehicle.

The Contacts menu accesses the phone book stored in the phone.

To make a call using the Contacts menu:

1. Touch the Phone icon on the infotainment home screen or on the shortcut tray near the left of the display.
2. Touch Contacts.
3. There are two methods to search for contacts:
 - Search bar – Touch the search icon on the top right of the Phone window and type the name or number of the contact on the

keyboard. Search results will be displayed corresponding to the user input. Touch the name to call.

- Scroll – Touch the list and scroll, or use the scrollbar on the left side of the Phone window. Touch the name to call.

Making a Call Using the Recent Menu

The Recent menu accesses the recent call list from your phone.

To make a call using the Recent menu:

1. Touch the Phone icon on the infotainment home screen or on the shortcut tray near the left of the display.
2. Touch Recent.
3. Touch the name or number to call.

Making a Call Using the Keypad

To make a call by dialling the numbers:

1. Touch the Phone icon on the infotainment home screen or on the shortcut tray near the left of the display.
2. Touch Keypad and enter a phone number.
3. Touch the phone icon on the infotainment display to start dialling the number.

Searching Contacts Using the Keypad

To search for contacts using the keypad:

1. Touch the Phone icon on the infotainment home screen.
2. Touch Keypad and enter partial phone numbers or contact names using the digits on the keypad to search.

Results appear on the right side of the display. Touch one to place a call.

Accepting or Declining a Call

When an incoming call is received, the infotainment system mutes and a ring tone is heard in the vehicle.

Accepting a Call

There are two ways to accept a call:

- Press  on the steering wheel controls.
- Touch Answer on the infotainment display.

Declining a Call

There are two ways to decline a call:

- Press  on the steering wheel controls.
- Touch Decline on the infotainment display.

Call Waiting

Call waiting must be supported on the Bluetooth phone and enabled by the wireless service carrier to work.

Accepting a Call

Press  to answer, then touch Switch on the infotainment display.



Declining a Call

Press  to decline, then touch Decline on the infotainment display.

Switching Between Calls (Call Waiting Calls Only)

To switch between calls, touch Phone on the infotainment home screen to display Call View. While in Call View, touch the call information of the call on hold to change calls.

Ending a Call

- Press  on the steering wheel controls.
- Touch  on the infotainment display, next to a call, to end only that call.

Dual Tone Multi-Frequency (DTMF) Tones

The in-vehicle Bluetooth system can send numbers during a call. This is used when calling a menu-driven phone system. Use the Keypad to enter the number.

Apple CarPlay and Android Auto

If equipped, Android Auto and/or Apple CarPlay capability may be available through a compatible smartphone. If available and connected, the Android Auto and Apple CarPlay icons will change from grey to white on the Home Page of the infotainment display.

To use Android Auto and/or Apple CarPlay:

For Wired Phone Projection

1. Download the Android Auto app to your smartphone from Google Play for phones running Android 9 and below. There is no app required for Apple CarPlay or newer versions of Android.
2. Connect your Android phone or Apple iPhone by using the factory-provided phone USB cable and plugging into a front USB data port. For best performance, it is highly recommended to use the device's factory-provided USB cable, which should be replaced after

significant wear to maintain connection quality. Aftermarket or third-party cables may not work.

- When the phone is first connected to activate Apple CarPlay or Android Auto, the “Terms and Conditions” consent will appear.
 - Touch Enable to launch Apple CarPlay or Android Auto.
 - Touch Disable to remove Apple CarPlay and Android Auto capability from the vehicle Settings menu. Other functions may still work.

For Wireless Phone Projection

- Download the Android Auto app to your smartphone from Google Play for phones running Android 9 and below. There is no app required for Apple CarPlay or newer versions of Android.
- For first time connection:
 - Connect the phone over Bluetooth. See *Bluetooth (Pairing and Using a Phone)* ⇨ 131 or *Bluetooth (Overview)* ⇨ 131.
- Make sure Wi-Fi and Bluetooth is turned on the phone for wireless projection to work.

- When the phone is first connected to activate Apple CarPlay or Android Auto, agree to the terms and conditions on the infotainment system. Touch Enable to launch Apple CarPlay or Android Auto.
- Follow the instructions on the phone.

The Android Auto and Apple CarPlay icons on the Home Page will illuminate depending on the smartphone. Android Auto and/or Apple CarPlay may automatically launch. If not, touch the Android Auto or Apple CarPlay icon on the Home Page to launch.



To disconnect the phones wireless projection:

- Select Settings from the Home Page.
- Select Connections.
- Select Phones.
- Touch Options on the phone card.
- Deactivate Apple CarPlay or Android Auto.

Press  on the centre console to return to the Home Page.

Features are subject to change. For further information on how to set up Android Auto and Apple CarPlay in the vehicle, see your vehicle’s brand website.

Android Auto is provided by Google and is subject to Google’s terms and privacy policy. Apple CarPlay is provided by Apple and is subject to Apple’s terms and privacy policy. Data plan rates apply. For Android Auto support see <https://support.google.com/androidauto>. For Apple CarPlay support see www.apple.com/ios/carplay/. Apple or Google may change or suspend availability at any time. Google, Android, Android Auto, Google Maps and other marks are trademarks of Google LLC. Apple CarPlay is a trademark of Apple Inc.

Press  on the centre console to exit Android Auto or Apple CarPlay. To enter back into Android Auto or Apple CarPlay, press and hold  on the centre console.

Apple CarPlay and Android Auto can be disabled from the infotainment system. To do this, touch Home>Settings>Connections>Phones and then Phone Options on the phone card. Use the On/Off toggled to turn off Apple CarPlay or Android Auto for that phone.

Settings

To access the Settings menus:

1. Touch Settings on the Home Page on the infotainment display.
2. Touch the desired category to display a list of available options.
3. Touch to select the desired feature setting.
4. Touch the options on the infotainment display to change a setting.
5. Touch < to go back.

The Settings menu may contain the following:

Connections

The menu may contain the following:

Phones

Allows connecting to a different mobile phone or mobile device source, disconnect a mobile phone or media device, or delete a mobile phone or media device.

Wi-Fi Networks

Shows connected and available Wi-Fi networks.

Wi-Fi Hotspot

Allows adjustment of different Wi-Fi features.

Vehicle-to-Phone Sharing

Vehicle

The menu may contain the following:

Rear Seat Reminder

Allows for a chime and a message when the rear door has been opened before or during operation of the vehicle.

Climate and Air Quality

Adjusts different climate settings.

Collision/Detection Systems

Adjusts different driver assistance system settings.

Comfort and Convenience

Adjusts different comfort and convenience settings.

Lighting

Adjusts different lighting settings.

Power Door Locks

Adjusts different door lock settings.

Remote Lock, Unlock, and Start

Adjusts different remote lock settings.

Seating Position

Adjusts different seating position settings.

Apps and Permissions

Shows a list of installed apps and the permissions used.

Date / Time

Allows setting of the clock.

Display

Allows adjustment of the infotainment display.

Sounds

Allows adjustment of the infotainment system sounds.

Users

Modifies the infotainment system's users.

Accounts

Allows adding or adjusting of the user accounts.

Privacy

This menu allows adjustment of the infotainment privacy settings.

Storage

This menu shows the storage info on the infotainment system.

Security

This menu allows adjustment of the infotainment security settings.

System

The menu may contain the following:

Language

This will set the display language used on the infotainment display.

Keyboard & speech

Touch to change keyboard and speech settings.

Units

Touch to change units settings.

Quick Start-up

This allows your infotainment system to quickly resume its last session.

While the vehicle is in park, press and hold the mute/end call button on the steering wheel for 15 seconds to reboot the infotainment system.

Reset Options

Touch to change reset settings.

About

Touch to view the infotainment system software information.

Legal Information

Touch to view legal and license information.

Updates

This menu allows adjustment of the vehicle update settings.

Google

This menu allows adjustment of the Google settings.

Trademarks and Licence Agreements



"Made for iPhone," means that an electronic accessory has been designed to connect specifically to iPhone, and has been certified by the developer to meet Apple performance standards. Apple is not responsible for the operation of this device or its compliance with safety and regulatory standards. Please note that the use of this accessory with iPhone may affect wireless performance. iPhone are trademarks of Apple Inc., registered in the U.S. and other countries.



immersion.

TouchSense Technology and TouchSense System 1000 Series Licensed from Immersion Corporation. TouchSense System 1000 protected under one or more of the U.S. Patents at the following address www.immersion.com/patent-marking.html and other patents pending.

Bluetooth

The Bluetooth word mark and logos are owned by the Bluetooth SIG, Inc. and any use of such marks by General Motors is under license. Other trademarks and trade names are those of their respective owners.

Java

Java is a registered trademark of Oracle and/or its affiliates.

MPEG4–AVC (H.264)

THIS PRODUCT IS LICENSED UNDER THE AVC PATENT PORTFOLIO LICENSE FOR THE PERSONAL AND NON-COMMERCIAL USE OF A CONSUMER TO (i) ENCODE VIDEO IN COMPLIANCE WITH THE AVC STANDARD (“AVC VIDEO”) AND/OR (ii) DECODE AVC VIDEO THAT WAS ENCODED BY A CONSUMER ENGAGED IN A PERSONAL AND NON-COMMERCIAL ACTIVITY AND/OR WAS OBTAINED FROM A VIDEO PROVIDER LICENSED TO PROVIDE AVC VIDEO. NO

LICENSE IS GRANTED OR SHALL BE IMPLIED FOR ANY OTHER USE. ADDITIONAL INFORMATION MAY BE OBTAINED FROM MPEG LA, LLC. SEE [HTTPS://WWW.MPEGLA.COM](https://www.mpegla.com).

MPEG4–Visual

USE OF THIS PRODUCT IN ANY MANNER THAT COMPLIES WITH THE MPEG-4 VISUAL STANDARD IS PROHIBITED, EXCEPT FOR USE BY A CONSUMER ENGAGING IN PERSONAL AND NON-COMMERCIAL ACTIVITIES.

MP3

MPEG Layer-3 audio coding technology licensed from Fraunhofer IIS and Thomson.

WMV/WMA

This product includes technology owned by Microsoft Corporation and under a license from Microsoft Licensing, GP. Use or distribution of such technology outside of this product is prohibited without a license from Microsoft Corporation and/or Microsoft Licensing, GP as applicable.

Climate Controls

Climate Control Systems

Dual Automatic Climate Control System 140
 Rear Climate Control System 144

Air Vents

Air Vents 145

Maintenance

Passenger Compartment Air Filter 145
 Service 147

Climate Control Systems

Dual Automatic Climate Control System

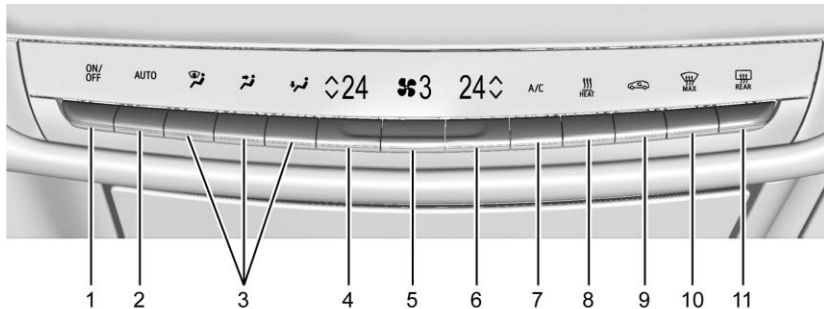

1. ON/OFF
2. AUTO (Automatic Operation)
3. Air Delivery Mode Controls
4. Driver Temperature
5. Fan Control
6. Passenger Temperature
7. Air Conditioning
8. HEAT
9. Recirculation
10. Max Defrost

11. Rear Window Demister

Climate Control Display

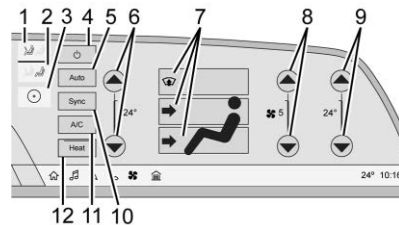

The fan, air delivery mode, air conditioning, temperature, and Sync settings can be controlled by touching CLIMATE on the infotainment home screen or the climate button in the climate control display application tray. A selection can then be made on the front or rear climate control page displayed.

1. Front Climate Control Selection
2. Rear Climate Control Selection (if equipped)
3. Personalisation Settings
4. On/Off (Power)
5. AUTO (Automatic Operation)
6. Driver Temperature
7. Air Delivery Mode Controls
8. Fan Control
9. Passenger Temperature
10. SYNC (Synchronised Temperature)
11. Air Conditioning
12. Heat

Automatic Operation

The system automatically controls the fan speed, air delivery, and recirculation to heat or cool the vehicle to the desired temperature.

When AUTO is underlined, the system is in full automatic operation. Either AC or HEAT will be underlined to indicate the system is automatically cooling or heating. Turning off the indicated button turns off that function resulting in fan operation only. If the air delivery mode or fan setting is manually adjusted, the auto indicator turns off and the display shows the selected settings. Auto operation can be turned off individually for climate settings.

For automatic operation:

1. Press AUTO.
2. Set the temperature. Allow the system time to stabilise. Then adjust the temperature as needed for best comfort.

To improve efficiency and to warm or cool the vehicle faster, recirculation is automatically selected. The recirculation light will not come on. Press  to select recirculation; press it again to select outside air.

English units can be changed to metric units through the instrument cluster. Select Settings > Time, Date, and Unit > US or Metric.

OFF : Press OFF to turn the fan on or off. When OFF is selected, the system stops air from flowing into the cabin. If ON is selected or any other buttons are pressed, the climate control system will turn on and operate at the current setting.

\wedge / \vee : The temperature can be adjusted separately for the driver and the passenger. Press to decrease or lift to increase the temperature. Press or lift and hold to rapidly increase or decrease the temperature. Press SYNC on the Climate Display to reset the Passenger Temperature to the Driver Temperature.

Rear Climate : If equipped, touch the rear climate selection on the infotainment screen to open the rear climate control screen. The rear climate control settings can now be adjusted from the front passenger area.

Manual Operation

\vee  \wedge : Press to decrease or lift to increase the fan speed. Press or lift and hold the fan controls to adjust speed more quickly. The fan speed setting displays. Any adjustment of the fan speed cancels automatic fan control and the fan can be controlled manually. Press AUTO to return to automatic operation.

To turn off the fan and climate control system, press OFF on the centre console climate controls. The airflow will be blocked from entering in all air delivery modes, except defrost.

The maximum automatic fan speed can be set to low, medium, or high. To adjust Auto Fan Speed, select Settings > Climate and Air Quality > Auto Fan Speed.

Air Delivery Mode Control : When the climate information is displayed, press the desired air delivery mode on the climate control display to change the direction of the airflow. The selected air delivery mode button is lit. Pressing any of the air delivery buttons cancels automatic air delivery control and the direction of the airflow can be controlled manually. Press AUTO to return to automatic operation.



To change the current mode, select one or more of the following:

 : Air is directed to the windscreen, outboard A/C outlets, and side window outlets.

 : Air is directed to the instrument panel outlets.

 : Air is directed to the floor outlets.

 **HEAT** : Touch to turn the automatic heater on or off. An indicator light comes on to show that the heater is enabled. If the fan is turned off, the heater will not run. Press AUTO to return to automatic operation.

 **MAX** : Clears the windscreen of mist or frost more quickly. Air is directed to the windscreen. Press  **MAX** to turn on or off. Changing the air delivery mode also turns the defrost off.

A/C : Touch A/C to turn the automatic air conditioning on or off. If the fan is turned off, the air conditioner will not run.

Press AUTO to return to automatic operation and the air conditioner runs as needed.

 : Press to alternate between recirculating air inside the vehicle or pulling in outside air. The indicator light on the button is lit when recirculation mode is active. This helps to quickly cool the air inside the vehicle and reduce the entry of outside air and odours.

Pressing this button cancels automatic recirculation. Press AUTO to return to automatic operation; recirculation runs automatically as needed.

Manual recirculation mode is not available when in Defrost.

The climate control system uses a sensor to automatically detect high humidity inside the vehicle. When high humidity is detected, the climate control system may adjust to outside air supply, turn on the heater and air conditioner, increase fan and temperature, and direct more air to the windscreen. When the climate control system does not detect possible window misting, it returns to normal operation. To turn Auto Demist off or on, select Settings > Climate and Air Quality > Auto Demist > Select ON or OFF. If Auto Demist is turned off, or misting does not clear quickly enough, select  **MAX** to more quickly clear the windscreen.

Rear Window Demister

 **REAR** : Press to turn the rear window demister on or off. An indicator light on the button comes on to show that the rear window demister is on.

The rear window demister only works when the vehicle is on.

The rear window demister can be set to automatic operation. When Auto Rear Demist is selected, the rear window

demister turns on automatically when the vehicle is first started in cold weather and turns off when the vehicle is warmed. To turn Auto Rear Demist off or on, select Settings > Climate and Air Quality > Auto Rear Demist > Select ON or OFF.

The heated outside rearview mirrors turn on when the rear window demister button is on and help to clear mist or frost from the surface of the mirrors.

Caution

Do not try to clear frost or other material from the inside of the front windscreen and rear window with a razor blade or anything else that is sharp. This may damage the rear window demister grid and affect the radio's ability to pick up stations clearly. The repairs would not be covered by the vehicle warranty.

Sensor

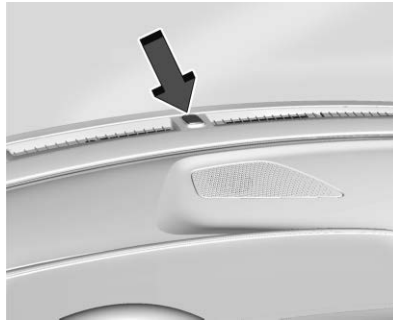

The solar sensor, on top of the instrument panel near the windscreen, monitors the solar heat.

The climate control system uses the sensor information to adjust the temperature, fan speed, recirculation, and air delivery mode for best comfort.

If the sensor is covered, the automatic climate control system may not work properly.

Remote Start Climate Control Operation :

The climate control system may run when the vehicle is started remotely. The system uses the driver's previous settings to heat or cool the inside of the vehicle. The rear demist may come on during remote start based on cold ambient conditions. The rear demist indicator light does not come on during a remote start. If equipped with heated or cooled seats, they may come on during a remote start. See *Remote Start* ⇨ 12 and *Heated and Ventilated Front Seats* ⇨ 40.

Afterblow Feature

If equipped, under certain conditions, the fan may stay on or may turn on and off several times after you turn off and lock the vehicle. This is normal.

Rear Climate Control System

If equipped, the rear climate control system is on the rear of the centre console.

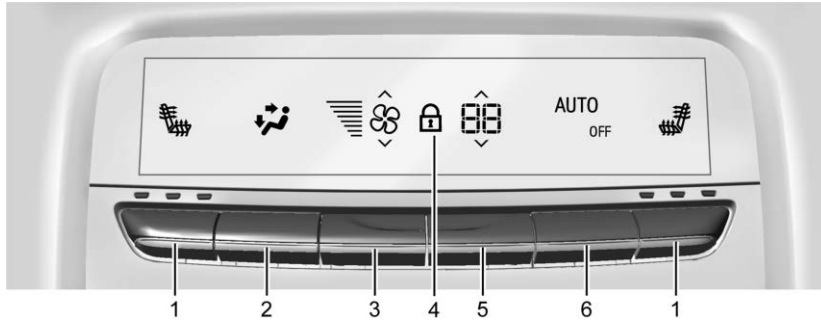

1. Rear Seat Passenger Heated Seat Controls
2. Air Delivery Mode Control
3. Fan Control
4. Rear Climate Lock
5. Rear Climate Temperature Control
6. AUTO (Automatic Operation)

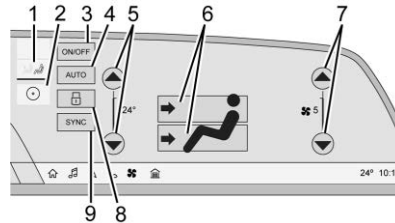

Rear Climate Display Controls

1. Rear Climate Control Selection
2. Personalisation Settings
3. ON/OFF

4. Auto (Rear Automatic Operation)
5. Rear Climate Temperature Control
6. Air Delivery Mode Control
7. Fan Control
8. Rear Control Lockout
9. Sync (Synchronized Temperatures)

Rear Climate Control Selection : Touch this button on the front climate control display to open the rear climate control display. The rear climate control settings can now be adjusted from the front passenger area.

ON/OFF : Touch ON/OFF on the display to turn the rear climate control on or off. If the rear climate control is turned off using ON/OFF on the display, the rear climate control buttons must be pressed twice to turn the system back on.

Sync : Touch Sync on the display to match the rear climate control settings to the front climate control driver settings. The Sync button is highlighted. Press the temperature button twice to unlink the set driver and rear settings. The Sync button is no longer highlighted.

 : Touch to lock or unlock control of the rear climate control system from the rear seat passengers. When locked, the rear climate controls can only be adjusted from the front seat.

Automatic Operation

AUTO : Press to turn on or off. The air delivery is controlled automatically. The AUTO indicator appears on the display. If the air delivery mode or fan speed is manually adjusted, this cancels full automatic operation.

Manual Operation

 : Press the rear fan control up or down to increase or decrease the airflow to the rear panel outlets. To turn ECO mode off or on, select Settings > Vehicle > Climate and Air Quality > Reduce Airflow to Empty Seats.

Temperature Controls : Press up or down to adjust the rear passenger temperature.

Air Delivery Mode Control : Press up or down to select the desired air delivery mode.

ECO Climate

When ECO Climate is on, airflow to unoccupied rear seats will be reduced for energy efficiency. To turn ECO Climate off or on, select Settings > Vehicle > Climate and Air Quality > ECO Climate.

Air Vents

Use the multi-function joystick control on the front centre and side air vents to change the direction of the airflow.

Air vents blow warm air on the side windows in cold weather. If floor, demist, or defrost modes are selected, a small amount of air will come from the vents close to the window.

To fully open the front A/C vents, turn the multi-function joystick control knob until the indicator points straight up.

To close the front A/C vents, turn the multi-function joystick control until the indicator points to the nine o'clock position.

To close the rear A/C vents, move the sliding knobs to the full inboard position.

Operation Tips

- Clear away any ice, snow, or leaves from air inlets at the base of the windshield that could block the flow of air into the vehicle.
- Clear snow off the bonnet to improve visibility and help decrease moisture drawn into the vehicle.
- Keep the path under the front seats clear of objects to help circulate the air inside of the vehicle more effectively.
- Use of non-GM approved bonnet air flow deflectors can adversely affect the performance of the system. Check with your Cadillac Brand Ambassador before adding equipment to the outside of the vehicle.
- Do not attach any devices to the air vent slats. This will restrict airflow and may cause damage to the air vents.

Maintenance

Passenger Compartment Air Filter

The filter reduces the dust, pollen and other airborne irritants from outside air that are drawn into the vehicle.

146 Climate Controls

The filter should be replaced as part of routine scheduled maintenance. To find out what type of filter to use, see *Maintenance Replacement Parts* ⇨ 292.

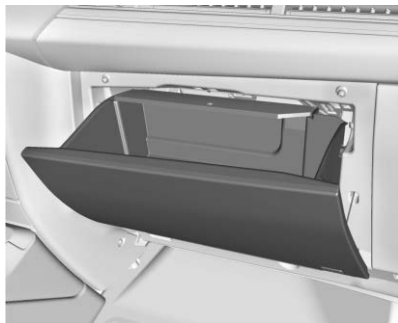

1. Open the glove box door completely.



2. Press the sides of the glove box bin inward to clear the stoppers and turn downward to lower the bin.



3. Unhook the string dampener to fully remove the glove box bin.

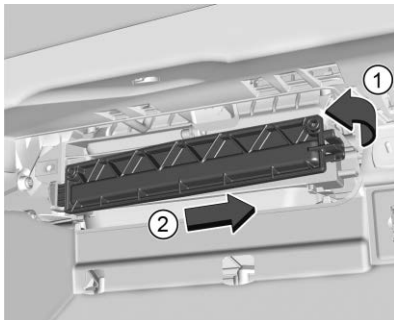

4. Release the clip (1) on the right side of the filter door and slide right (2), then remove the door. Remove the old filter.
5. Install the new air filter.
6. Reinstall the filter door.
7. Reverse the steps to reinstall the glove box.

See your Cadillac Brand Ambassador if additional assistance is needed.

Service

All vehicles have a label underbonnet that identifies the refrigerant used in the vehicle. The refrigerant system should only be serviced by trained and certified technicians. The air conditioning evaporator should never be repaired or replaced by one from a salvage vehicle. It should only be replaced by a new evaporator to ensure proper and safe operation.

During service, all refrigerants should be reclaimed with proper equipment. Venting refrigerants directly to the atmosphere is harmful to the environment and may also create unsafe conditions based on inhalation, combustion, frostbite, or other health-based concerns.

The air conditioning system requires periodic maintenance. See *Maintenance Schedule* ⇨ 289.

Driving and Operating

Driving Information

Driving for Better Energy Efficiency ...	149
Distracted Driving	150
Defensive Driving	151
Control of a Vehicle	151
Braking	151
Steering	151
Off-Road Recovery	152
Loss of Control	152
Driving on Wet Roads	153
Hill and Mountain Roads	154
Winter Driving	154
If the Vehicle Is Stuck	155
Vehicle Load Limits	155

Starting and Operating

New Vehicle Run-In	158
Power Button	159
Starting and Stopping the Vehicle	160
Retained Accessory Power (RAP)	161
Shifting Into Park	161
Shifting out of Park	161
Extended Parking	162

Electric Drive Unit

Electric Drive Unit	162
One-Pedal Driving	165

Drive Systems

All-Wheel Drive	166
-----------------------	-----

Brakes

Electric Brake Boost	166
Antilock Brake System (ABS)	166
Electric Parking Brake	167
Brake Assist	168
Hill Start Assist (HSA)	168
Automatic Vehicle Hold (AVH)	168
Regenerative Braking	169

Ride Control Systems

Traction Control/Electronic Stability Control	170
Driver Mode Control	171

Cruise Control

Adaptive Cruise Control (Advanced)	173
---	-----

Advanced Driver Assistance Systems

Advanced Driver Assistance Systems ...	182
Assistance Systems for Parking or Reversing	184
Rear Vision Camera (RVC)	184
Surround Vision System	185
Park Assist	187
Automatic Parking Assist (APA)	188
Reverse Automatic Braking (RAB)	191
Rear Pedestrian Alert	192

Rear Cross Traffic Alert (RCTA)

System	193
Assistance Systems for Driving	194
Speed Limiter	194
Forward Collision Alert (FCA) System	196
Automatic Emergency Braking (AEB) ...	198
Front Pedestrian Braking (FPB) System	202
Side Blind Zone Alert (SBZA)	204
Lane Change Alert (LCA)	204
Blind Zone Steering Assist (BZSA)	206
Traffic Sign Assistant	206
Driver Attention Assist	208
Lane Keep Assist (LKA)	210

Charging

When to Charge	211
Plug-In Charging	212
Delayed Charging Override	216
Charging Status Feedback	217
Charge Cord	218
Interruption of Charging by the Electricity Supplier	225
Electrical Requirements for Battery Charging	225

Trailer Towing

General Towing Information	225
Driving Characteristics and Towing Tips	225

Trailer Towing	228
Towing Equipment	231
Trailer Sway Control (TSC)	239

Conversions and Add-Ons

Add-On Electrical Equipment	240
-----------------------------------	-----

Driving Information

Driving for Better Energy Efficiency

Use the tips in the categories below to help maximise energy efficiency and range.

In colder temperatures, while these efficiency tips will help, the electric vehicle driving range will be lower due to higher energy usage including energy spent heating the cabin.

The Energy Usage card available on the Driver Information Centre (DIC) estimates the influence of the main factors impacting vehicle range. It displays how energy is being used for the current drive since the last time the vehicle was started. See *Driver Information Centre (DIC)* ⇨ 105 and *Vehicle Status* ⇨ 106.

Acceleration/Braking/Coasting

Avoid rapid accelerations and decelerations.

Use cruise control when appropriate.

Plan ahead for decelerations, and coast whenever possible. Do not rush to traffic lights, and do not shift to N (Neutral) to coast.

Use the One-Pedal Driving feature when appropriate to help recover energy during coasting and braking. One-Pedal mode recovers more energy while coasting and braking than D (Drive) mode. See *One-Pedal Driving* ⇨ 165.

Use the steering wheel Regen on Demand paddle during deceleration to help recover energy. See *Regenerative Braking* ⇨ 169.

Terrain and Vehicle Speed

Higher speeds and gradient changes use more energy and can significantly reduce electric range.

Climate Setting

Using the heat and air conditioning systems decreases the energy available for electric driving. Optimal energy efficiency is achieved when the heat, air conditioning, and fan are turned off.

Use the heated and ventilated seat features (if equipped) instead of the climate control system. Heating and ventilating the seat uses less energy than heating and cooling the interior. See *Heated and Ventilating Front Seats* ⇨ 40 and *Heated Rear Seats* ⇨ 44.

Use the Remote Start Climate Control feature to heat or cool the interior while the vehicle is plugged in to use electricity from the electrical socket instead of using energy from the battery. See *Remote Start* ⇨ 12.

In hot weather, avoid parking in direct sunlight. Use sunshades inside the vehicle.

Keep the inside of the windows clean to reduce misting. Turn off the front demister and rear demister when they are not needed.

Avoid driving with the windows open at highway speeds.

Use the Battery Gauge on the Instrument Cluster to view the effect of climate control settings on your estimated range. See *Battery Gauge (High Voltage)* ⇨ 89.

Outside Temperature

On colder days, it is best to plug in the vehicle overnight, and then remote start the vehicle.

Allow the vehicle to warm up for 20 minutes before driving.

Vehicle Charging/Maintenance

Charging

Keep the vehicle plugged in, even when fully charged, to keep the battery temperature ready for the next drive. This is important when outside temperatures are extremely hot or cold.

If possible, use a level 2 (240 volt) high power charge station for best results. This allows the interior of the vehicle and high voltage battery to warm to optimal temperature.

Maintenance

Always keep the tyres properly inflated and the vehicle properly aligned.

Carrying excess loads in the vehicle affects efficiency and range. Avoid carrying more than is needed.

Avoid unnecessary use of electrical accessories. Power used for functions other than propelling the vehicle will reduce the available range.

Using a rooftop carrier will reduce efficiency due to additional weight and drag.

Distracted Driving

Distraction comes in many forms and can take your focus from the task of driving. Exercise good judgement and do not let other activities divert your attention away from the road. Many local governments have enacted laws regarding driver distraction. Become familiar with the local laws in your area.

To avoid distracted driving, keep your eyes on the road, keep your hands on the steering wheel, and focus your attention on driving.

- Do not use a mobile phone in demanding driving situations. Use a hands-free method to place or receive necessary phone calls.
- Watch the road. Do not read, take notes, or look up information on mobile phones or other electronic devices.
- Designate a front seat passenger to handle potential distractions.
- Become familiar with vehicle features before driving, such as programming favourite radio stations and adjusting climate control and seat settings. Program all trip information into any navigation device prior to driving.

- Wait until the vehicle is parked to retrieve items that have fallen to the floor.
- Stop or park the vehicle to tend to children.
- Keep pets in an appropriate carrier or restraint.
- Avoid stressful conversations while driving, whether with a passenger or on a mobile phone.

Warning

Taking your eyes off the road too long or too often could cause a crash resulting in injury or death. Focus your attention on driving.

Refer to the Infotainment section for more information on using that system, including pairing and using a mobile phone.

Defensive Driving

Defensive driving means “always expect the unexpected.” The first step in driving defensively is to wear the seat belt. See *Seat Belts* ⇨ 44.

- Assume that other road users (pedestrians, bicyclists, and other drivers) are going to be careless and make mistakes. Anticipate what they may do and be ready.
- Allow enough following distance between you and the driver in front of you.
- Focus on the task of driving.

Control of a Vehicle

Braking, steering, and accelerating are important factors in helping to control a vehicle while driving.

Braking

Braking action involves perception time and reaction time. Deciding to push the brake pedal is perception time. Actually doing it is reaction time.

Average driver reaction time is about three-quarters of a second. In that time, a vehicle moving at 100 km/h (60 mph) travels 20 m (66 ft), which could be a lot of distance in an emergency.

Helpful braking tips to keep in mind include:

- Keep enough distance between you and the vehicle in front of you.
- Avoid needless heavy braking.

- Keep pace with traffic.

Steering

Caution

To avoid damage to the steering system, do not drive over kerbs, parking barriers, or similar objects at speeds greater than 3 km/h (1 mph). Use care when driving over other objects such as lane dividers and speed bumps. Damage caused by misuse of the vehicle is not covered by the vehicle warranty.

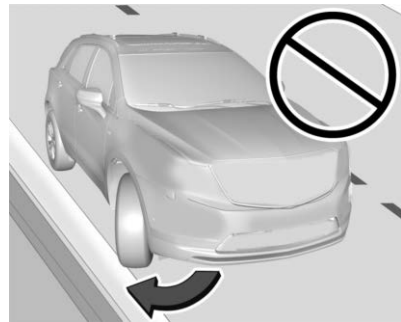

Electric Power Steering

The vehicle is equipped with an electric power steering system, which reduces the amount of effort needed to steer the vehicle. It does not have power steering fluid. Regular maintenance is not required.

If the vehicle experiences a system malfunction and loses power steering, greater steering effort may be required. Power steering assist also may be reduced if you turn the steering wheel as far as it can turn and hold it there with force for an extended period of time.

See your Cadillac Service Centre if there is a problem.

Bend Tips

- Take bends at a reasonable speed.
- Reduce speed before entering a bend.
- Maintain a reasonable steady speed through the bend.
- Wait until the vehicle is out of the bend before accelerating gently into the straight.

Steering in Emergencies

- There are some situations when steering around a problem may be more effective than braking.

- Holding both sides of the steering wheel allows you to turn 180 degrees without removing a hand.
- The Antilock Brake System (ABS) allows steering while braking.

Off-Road Recovery

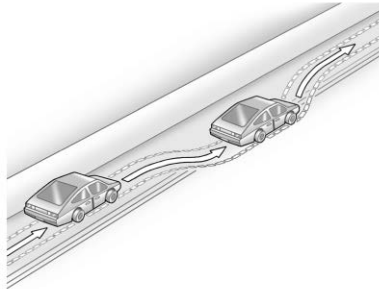

The vehicle's right wheels can drop off the edge of a road onto the shoulder while driving. Follow these tips:

1. Ease off the accelerator and then, if there is nothing in the way, steer the vehicle so that it straddles the edge of the pavement.

2. Turn the steering wheel about one-eighth of a turn, until the right front tyre contacts the pavement edge.
3. Turn the steering wheel to go straight down the roadway.

Loss of Control

Skidding

There are three types of skids that correspond to the vehicle's three control systems:

- Braking Skid - wheels are not rolling.
- Steering or Cornering Skid - too much speed or steering in a bend causes tyres to slip and lose cornering force.
- Acceleration Skid - too much throttle causes the driving wheels to spin.

Defensive drivers avoid most skids by taking reasonable care suited to existing conditions, and by not overdriving those conditions. But skids are always possible.

If the vehicle starts to slide, follow these suggestions:

- Ease your foot off the accelerator pedal and steer the way you want the vehicle to go. The vehicle may straighten out. Be ready for a second skid if it occurs.

- Slow down and adjust your driving according to weather conditions. Stopping distance can be longer and vehicle control can be affected when traction is reduced by water, snow, ice, gravel, or other material on the road. Learn to recognise warning clues - such as enough water, ice, or packed snow on the road to make a mirrored surface - and slow down when you have any doubt.
- Try to avoid sudden steering, acceleration, or braking, including reducing vehicle speed by shifting to a lower gear. Any sudden changes could cause the tyres to slide.

Remember: Antilock brakes help avoid only the braking skid.

Driving on Wet Roads

Rain and wet roads can reduce vehicle traction and affect your ability to stop and accelerate. Always drive slower in these types of driving conditions and avoid driving through large puddles and deep-standing or flowing water.

Warning

Wet brakes can cause crashes. They might not work as well in a quick stop and could cause pulling to one side. You could lose control of the vehicle.

After driving through a large puddle of water or a car/vehicle wash, lightly apply the brake pedal until the brakes work normally.

Flowing or rushing water creates strong forces. Driving through flowing water could cause the vehicle to be carried away. If this happens, you and other vehicle occupants could drown. Do not ignore police warnings and be very cautious about trying to drive through flowing water.

Aquaplaning

Aquaplaning is dangerous. Water can build up under the vehicle's tyres so they actually ride on the water. This can happen if the road is wet enough and you are going fast enough. When the vehicle is aquaplaning, it has little or no contact with the road.

There is no hard and fast rule about aquaplaning. The best advice is to slow down when the road is wet.

Other Rainy Weather Tips

Besides slowing down, other wet weather driving tips include:

- Allow extra following distance.
- Overtake with caution.
- Keep windscreen wiping equipment in good condition, and keep the windscreen washer fluid reservoir filled.
- Have good tyres with proper tread depth. See *Tyres* ⇨ 263.
- Turn off cruise control, if equipped. See *Adaptive Cruise Control (Advanced)* ⇨ 173.
- Turn off One-Pedal Driving mode. See *One-Pedal Driving* ⇨ 165.
- Turn on the Traction Control System (TCS) and the Electronic Stability Control (ESC). See *Traction Control/Electronic Stability Control* ⇨ 170.

Hill and Mountain Roads

Warning

Do not charge your vehicle's battery above an 80% charge if you are going to drive down long, steep gradients such as mountain passes. This provides room in the battery for regenerative braking to supplement your conventional brakes during the descent. This is especially important when towing a trailer, which puts additional stress on your vehicle's braking system.

If the battery becomes full, regenerative braking will be limited or unavailable. The brakes will have to do all the work of slowing down the vehicle and could become too hot. Hot brakes may not be able to slow the vehicle enough to maintain speed and control. To help avoid the risk of a collision, limit the battery's charge and, if you experience brake fade or receive a brake warning, stop the vehicle and allow the brakes to cool.

See "Charge Now" under *Charging* ⇨ 100 for information on setting charge limits.

Driving on steep hills or through mountains is different than driving on flat or rolling terrain. Be sure to:

- Use regenerative braking to help slow the vehicle or maintain speed by keeping the vehicle in gear and limiting the initial battery charge to 80% or less. See *Regenerative Braking* ⇨ 169.
- When braking is necessary, use frequent, light taps of the brake pedal. This maximises regenerative braking and minimises the load on the vehicle brake system.
- Keep the vehicle serviced and in good shape.
- Check all fluid levels, brakes, tyres, and cooling system.
- Drive at speeds that keep the vehicle in its own lane. Do not swing wide or cross the centre line.
- Be alert on top of hills; something could be in your lane (e.g. stalled car, crash).
- Pay attention to special road signs (e.g., falling rocks area, winding roads, long gradients, overtaking or no-overtaking zones) and take appropriate action.

Winter Driving

Driving on Snow or Ice

Caution

To avoid damage to the wheels and brake components, always clear snow and ice from inside the wheels and underneath the vehicle before driving.

Snow or ice between the tyres and the road creates less traction or grip, so drive carefully. Wet ice can occur at about 0°C (32°F) when freezing rain begins to fall. Avoid driving on wet ice or in freezing rain until roads can be treated.

For Slippery Road Driving:

- Turn off cruise control.
- If enabled, turn off One-Pedal Driving. See *One-Pedal Driving* ⇨ 165.
- If turned off, turn on the Traction Control and the Electronic Stability Control systems. See *Traction Control/Electronic Stability Control* ⇨ 170.
- Select the Snow/Ice driver mode. See *Driver Mode Control* ⇨ 171.

- Accelerate gently. Accelerating too quickly causes the wheels to spin and makes the surface under the tyres slick.
- Allow greater following distance and watch for slippery spots. Icy patches can occur on otherwise clear roads in shaded areas. The surface of a curve or an overpass can remain icy when the surrounding roads are clear. Avoid sudden steering manoeuvres and braking while on ice.
- Antilock Brake System (ABS) improves vehicle stability during hard stops, but the brakes should be applied sooner than when on dry pavement. See *Antilock Brake System (ABS)* ⇨ 166.
- Avoid using the Regen on Demand paddle. See *Regenerative Braking* ⇨ 169.

Blizzard Conditions

If you become stranded or cannot continue driving due to winter storm conditions, stop the vehicle in a safe place and signal for help. Stay with the vehicle unless there is help nearby.

If you stay in your vehicle while waiting, signal for help and keep everyone in the vehicle safe by turning on the hazard warning lights and tying a red cloth to an outside mirror.

To conserve battery energy while waiting for help, run the vehicle for only short periods as needed to warm the vehicle and then shut the vehicle off and partially close the window. Moving about to keep warm also helps. For additional tips to help conserve battery energy in cold weather, see *Driving for Better Energy Efficiency* ⇨ 149.

If the Vehicle Is Stuck

Slowly and cautiously spin the wheels to free the vehicle when stuck in sand, mud, ice, or snow. See "Rocking the Vehicle to Get It Out" later in this section.

The Traction Control System (TCS) can often help to free a stuck vehicle. See *Traction Control/Electronic Stability Control* ⇨ 170. If stuck too severely for the TCS to free the vehicle, turn off the TCS and use the rocking method. See "Rocking the Vehicle to Get It Out" later in this section.

Warning

If the vehicle's tyres spin at high speed, they can explode, and you or others could be injured. Spin the wheels as little as possible and avoid going above 56 km/h (35 mph).

Rocking the Vehicle to Get it Out

Turn the steering wheel left and right to clear the area around the front wheels. Turn off the TCS. Shift back and forth between R (Reverse) and a forward gear, spinning the wheels as little as possible. To prevent electric drive unit wear, wait until the wheels stop spinning before shifting gears. Slowly spinning the wheels in the forward and reverse directions causes a rocking motion that could free the vehicle. If that does not get the vehicle out after a few tries, it might need to be towed out. See *Transporting a Disabled Vehicle* ⇨ 278.

Vehicle Load Limits

It is very important to know how much weight the vehicle can carry. This weight is called the vehicle capacity weight and includes the weight of all occupants, cargo, and all

non-factory-installed options. Two labels on the vehicle may show how much weight it may properly carry: the Tyre and Loading Information label and the Certification label.

Warning

Do not load the vehicle any heavier than the Gross Vehicle Weight Rating (GVWR), or either the maximum front or rear Gross Axle Weight Rating (GAWR). This can cause systems to break and change the way the vehicle handles. This could cause loss of control and a crash. Overloading can also reduce stopping performance, damage the tyres, and shorten the life of the vehicle.

Tyre and Loading Information Label

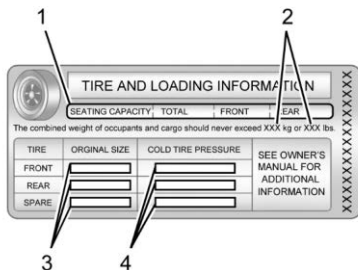

Label Example

A vehicle-specific Tyre and Loading Information label is attached to the vehicle's centre pillar (B-pillar). The Tyre and Loading Information label shows the number of occupant seating positions (1), and the maximum vehicle capacity weight (2) in kilogrammes and pounds.

The Tyre and Loading Information label also shows the tyre size of the original equipment tyres (3) and the recommended cold tyre inflation

pressures (4). For more information on tyres and inflation see *Tyres* ⇨ 263 and *Tyre Pressure* ⇨ 265.

There is also important loading information on the Certification label. It may show the Gross Vehicle Weight Rating (GVWR) and the Gross Axle Weight Rating (GAWR) for the front and rear axle. See "Certification Label" later in this section.

"Steps for Determining Correct Load Limit–

1. Locate the statement "The combined weight of occupants and cargo should never exceed XXX kg or XXX lbs." on your vehicle's placard.
2. Determine the combined weight of the driver and passengers that will be riding in your vehicle.
3. Subtract the combined weight of the driver and passengers from XXX kg or XXX lbs.
4. The resulting figure equals the available amount of cargo and luggage load capacity. For example,

if the “XXX” amount equals 1400 lbs. and there will be five 150 lb passengers in your vehicle, the amount of available cargo and luggage load capacity is 650 lbs. (1400-750 (5 x 150) = 650 lbs.)

5. Determine the combined weight of luggage and cargo being loaded on the vehicle. That weight may not safely exceed the available cargo and luggage load capacity calculated in Step 4.
6. If your vehicle will be towing a trailer, load from your trailer will be transferred to your vehicle. Consult this manual to determine how this reduces the available cargo and luggage load capacity of your vehicle.”

This vehicle is neither designed nor intended to tow a trailer.

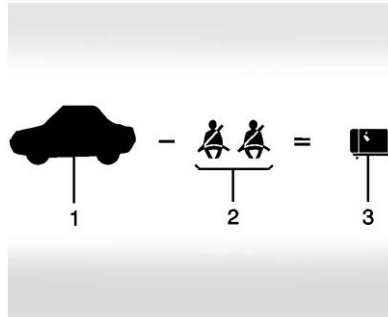

Example 1

1. Vehicle Capacity Weight for Example 1 = 453 kg (1,000 lbs).
2. Subtract Occupant Weight @ 68 kg (150 lbs) × 2 = 136 kg (300 lbs).
3. Available Occupant and Cargo Weight = 317 kg (700 lbs).

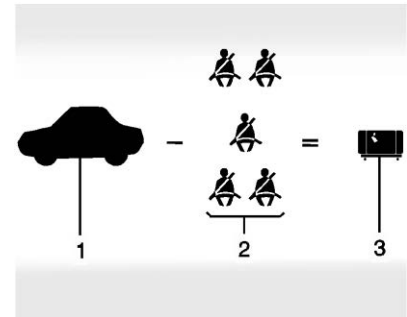

Example 2

1. Vehicle Capacity Weight for Example 2 = 453 kg (1,000 lbs).
2. Subtract Occupant Weight @ 68 kg (150 lbs) × 5 = 340 kg (750 lbs).
3. Available Cargo Weight = 113 kg (250 lbs).

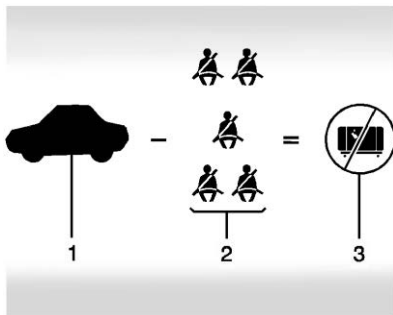

Example 3

1. Vehicle Capacity Weight for Example 3 = 453 kg (1,000 lbs).
2. Subtract Occupant Weight @ 91 kg (200 lbs) × 5 = 453 kg (1,000 lbs).
3. Available Cargo Weight = 0 kg (0 lbs).

Refer to the vehicle's Tyre and Loading Information label for specific information about the vehicle's capacity weight and seating positions. The combined weight of the driver, passengers, and cargo should never exceed the vehicle's capacity weight.

Certification Label

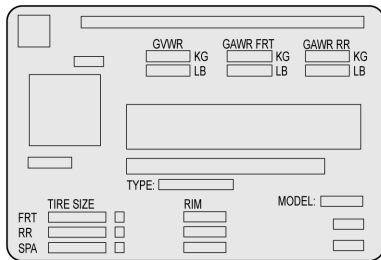

Label Example

A vehicle-specific Certification label is attached to the vehicle's centre pillar (B-pillar). The label may show the gross weight capacity of the vehicle, called the Gross Vehicle Weight Rating (GVWR). The GVWR includes the weight of the vehicle, all occupants, and cargo.

Warning

Things inside the vehicle can strike and injure people in a sudden stop or turn, or in a crash.

(Continued)

Warning (Continued)

- Put things in the cargo area of the vehicle. In the cargo area, put them as far forward as possible. Try to spread the weight evenly.
- Never stack heavier things, like suitcases, inside the vehicle so that some of them are above the tops of the seats.
- Do not leave an unsecured child restraint in the vehicle.
- Secure loose items in the vehicle.
- Do not leave a seat folded down unless needed.

Starting and Operating

New Vehicle Run-In

Caution

Avoid braking hard for the first 322 km (200 mi). During this time the new brake linings are not yet broken in. Hard stops with new linings can mean premature

(Continued)

Caution (Continued)

wear and earlier replacement. Follow this breaking-in guideline every time you get new brake linings. Following run-in, vehicle speed and load can be gradually increased.

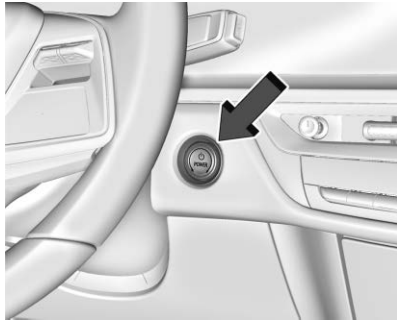

Power Button

The vehicle has an electronic pushbutton start.

The Remote Key must be in the vehicle for the system to operate. If the vehicle will not start, place the Remote Key in the transmitter pocket, inside the centre console.

ON/RUN : This position is for starting and driving. With the vehicle off, and the brake pedal applied, pressing POWER  once will place the vehicle in ON/RUN. When the vehicle ready light is on in the instrument cluster, the vehicle is ready to be driven. This could take up to 15 seconds at extremely cold temperatures.

Service Mode

This power mode is available for service and diagnostics, and to verify the proper operation of the service vehicle soon light as may be required for inspection or maintenance purposes. With the vehicle off, and the brake pedal not applied, pressing and holding POWER  for more than five seconds will place the vehicle in Service Mode. The instruments and audio systems will operate as they do in ON/RUN, but the vehicle will not be able to be driven. The propulsion system will not start in Service Mode. Press POWER  again to turn the vehicle off.

Caution

Placing the vehicle in Service Mode will use the 12-volt battery. Do not use Service Mode for an extended period, or the vehicle may not start.

STOPPING THE VEHICLE/OFF : To turn the vehicle off, apply the brakes, press the button on top of the gear lever to shift to P (Park) and press POWER .

Alternatively, apply the brakes and press POWER . The electric drive unit will shift to P (Park) then shut off automatically.

Retained Accessory Power (RAP) will remain active until the driver door is opened.

If the vehicle must be shut off in an emergency:

1. Brake using a firm and steady pressure. Do not pump the brakes repeatedly. This may deplete power assist, requiring increased brake pedal force.
2. Shift the vehicle to N (Neutral). This can be done while the vehicle is moving. After shifting to N (Neutral), firmly apply the brakes and steer the vehicle to a safe location.

3. Come to a complete stop, shift to P (Park), and turn the vehicle off by pressing POWER .
4. Apply the parking brake.

 **Warning**

Turning off the vehicle while moving may disable the airbags. While driving, only shut the propulsion system off in an emergency.

If the vehicle cannot be pulled over, and must be shut off while driving, press and hold POWER  for longer than two seconds, or press twice in five seconds.

Starting and Stopping the Vehicle

Starting Procedure

Press the P (Park) button on the gear lever, or move the gear lever into N (Neutral). The propulsion system will not start in any other position.

Caution

Do not try to shift to P (Park) if the vehicle is moving or the electric drive unit could be damaged. Shift to P (Park) only when the vehicle is stopped.

Caution

If you add electrical parts or accessories, you could change the way the vehicle operates. Any resulting damage would not be covered by the vehicle warranty.

The Remote Key must be in the vehicle. Press the brake pedal, then press and release POWER .

If the Remote Key is not in the vehicle or something is interfering with the Remote Key, a message displays in the Driver Information Centre (DIC).

If the vehicle will not start due to a low Remote Key battery, the vehicle can still be driven. See *Remote Key Operation* ⇨ 7.



A vehicle ready light displays on the instrument cluster when the vehicle is ready to be driven.

The instrument cluster also displays an active battery gauge when the vehicle is ready to be driven.

Restarting Procedure

If the vehicle must be restarted while it is still moving, move the gear lever to N (Neutral) and press POWER  twice without pressing the brake pedal. The propulsion system will not restart in any other position.

A chime will sound if the driver door is opened while the vehicle is on. Always press POWER  to turn the vehicle off before exiting.

Stopping Procedure

For information on how to turn the vehicle off, see *Power Button* ⇨ 159.

Retained Accessory Power (RAP)

When the vehicle is turned from on to off, the following features (if equipped) will continue to function for up to 10 minutes, or until the driver door is opened.

- Infotainment System
- Power Windows (during RAP this functionality will be lost when any door is opened)
- Sunroof (during RAP this functionality will be lost when any door is opened)
- Auxiliary Power Socket
- Audio System
- OnStar System

Shifting Into Park

To shift into P (Park):

1. Hold the brake pedal down and set the parking brake. See *Electric Parking Brake* ⇨ 167.
2. Press the P (Park) switch at the end of the gear lever. See *Electric Drive Unit* ⇨ 162.
3. The P indicator on the gear lever will turn red when the vehicle is in P (Park).
4. Turn the vehicle off.

If the vehicle is shifted into P (Park) on a hill, the Electric Parking Brake (EPB) may apply automatically. The driver may not be able to release the EPB using the EPB switch. It should automatically release when the vehicle is shifted out of P (Park).

Leaving the Vehicle with the Propulsion System On

Warning

It is dangerous to get out of the vehicle if the vehicle is not in P (Park) with the parking brake set. The vehicle can roll.

Do not leave the vehicle when the propulsion system is on. If you have left the propulsion system on, the vehicle can move suddenly. You or others could be injured. To be sure the vehicle will not move, even when you are on fairly level ground, always apply the parking brake and press the P (Park) button. See *Shifting Into Park* ⇨ 161.

If the vehicle must be left with the propulsion system on, be sure that the vehicle is in P (Park) with the parking brake set, before leaving the vehicle. After pressing the P (Park) button, hold down the regular

brake pedal. If you cannot see the P (Park) indicator in the instrument cluster, it means that the vehicle has not shifted to P (Park).

Shifting out of Park

This vehicle is equipped with an electric drive unit. To shift out of P (Park) the vehicle must be on, the brake pedal applied, and the charging cable unplugged.

Parking the vehicle in extreme cold for several days without the charging cable connected may cause the vehicle not to start. Plug the vehicle in to allow the high voltage battery to be warmed sufficiently.

To shift out of P (Park):

1. Apply the brake pedal.
2. Press POWER  to turn the vehicle on.
3. Verify that the vehicle is unplugged and the vehicle ready light is on.
4. Move the shift lever to the desired position.

After releasing the gear lever, it will return to the centre position.

The P indicator will turn white and the gear indicator on the gear lever will turn red when the vehicle is no longer in P (Park).

If the vehicle cannot shift from P (Park), a Driver Information Centre (DIC) message may be displayed. Check that the vehicle is on, the vehicle ready light is on, and the brake pedal is applied when you are attempting to shift out of P (Park). If all of these are met but the vehicle will not shift out of P (Park), see your Cadillac Service Centre.

Extended Parking

It is best not to park with the propulsion system on. If the vehicle is left on, be sure it will not move.

See *Shifting Into Park* ⇨ 161.

If the vehicle is left parked and on with the remote key outside the vehicle, it will remain on for up to one hour.

If the vehicle is left parked and on with the remote key inside the vehicle, it will remain on for up to two hours.

The timer will reset if the vehicle is taken out of P (Park) while it is on.

See *Remote Key Operation* ⇨ 7 and *Digital Key* ⇨ 15.

Electric Drive Unit



The vehicle uses an electric drive unit. The shift pattern is displayed on the front of the gear lever. The selected gear position will illuminate red on the gear lever, while all others will be displayed in white. If the shift is not immediate, as in very cold conditions, the indicator on the shift switch may flash until it is fully engaged.

P :



If the vehicle is on, the vehicle can be shifted into P (Park).

If POWER ⏻ is pressed twice while at a relatively high speed, the vehicle will turn off and automatically shift to N (Neutral). Once the vehicle is stopped, P (Park) can be selected.

Warning

It is dangerous to get out of the vehicle if the P (Park) button is not pressed with the parking brake applied. The vehicle can roll.

(Continued)

Warning (Continued)

Do not leave the vehicle when the propulsion system is running. If you have left the propulsion system running, the vehicle can move suddenly. You or others could be injured. To be sure the vehicle will not move, even when you are on fairly level ground, always apply the parking brake and press the P (Park) button.

When the vehicle is stopped, press POWER  to turn off the vehicle. The vehicle will shift to P (Park) automatically unless the vehicle is in N (Neutral), see “Car Wash Mode” later in this section.

The vehicle will not shift into P (Park) if it is moving too fast. Stop the vehicle and shift into P (Park).

To shift in and out of P (Park), see *Shifting Into Park* ⇨ 161 and *Shifting out of Park* ⇨ 161.

R : Use this gear to reverse.

If the vehicle is shifted from either R (Reverse) to D (Drive) or D (Drive) to R (Reverse) while the speed is too high, the vehicle may shift to N (Neutral). Reduce the vehicle speed and try the shift again.

To shift into R (Reverse):

1. Bring the vehicle to a complete stop.
2. From the centre position, move the gear lever rearward toward you, and then up. R is illuminated in red.
3. After releasing the gear lever, it will return to the centre position.

To shift out of R (Reverse):

1. Bring the vehicle to a complete stop.
2. Shift to the desired gear.
3. After releasing the gear lever, it will return to the centre position.

At low vehicle speeds, R (Reverse) can be used to rock the vehicle back and forth to get out of snow, ice, or sand without damaging the electric drive unit. See *If the Vehicle Is Stuck* ⇨ 155.

N : In this position, the propulsion system is inactive. If the vehicle is moving and turned off, restart the propulsion system in N (Neutral) only.

Caution

The vehicle is not designed to stay in N (Neutral) for extended periods of time. It will automatically shift into P (Park).

To shift into N (Neutral):

1. Move the gear lever rearward toward the driver.
 - If the vehicle is in P (Park), apply the brake pedal while moving the gear lever rearward.
 - The N indicator will illuminate red.
2. After releasing the gear lever, it will return to the centre position.

To shift out of N (Neutral):

1. Bring the vehicle to a complete stop.
2. Hold the brake pedal down
3. Shift into the desired gear.

If the brake pedal is not applied, the vehicle may remain in N (Neutral).

Car Wash Mode

This vehicle includes a Car Wash Mode that allows the vehicle to remain in N (Neutral) for use in automatic car washes.

Car Wash Mode is not to be used for vehicle towing. If the vehicle needs to be towed, see *Transporting a Disabled Vehicle* ⇨ 278.

Caution

The vehicle is not designed to stay in N (Neutral) for extended periods of time. It will automatically shift into P (Park).

Car Wash Mode (Vehicle Off) – Driver In Vehicle

To place the vehicle in N (Neutral) with the vehicle off and occupied:

1. Drive to the entrance of the car wash.
2. Apply the brake pedal.
3. Shift to N (Neutral).
4. Turn off the vehicle and release the brake pedal.
5. The indicator should continue to show N. If it does not, repeat Steps 2–4.
6. Lock the doors with the interior lock switch or remote key to ensure that the outside door handles retract. The vehicle is now ready for the car wash.

Car Wash Mode (Vehicle Off) – Driver Out of Vehicle

To place the vehicle in N (Neutral) with the vehicle off and unoccupied:

1. Drive to the entrance of the car wash.
2. Apply the brake pedal.
3. Open the door.
4. Shift to N (Neutral).
5. Turn off the vehicle and release the brake pedal.
6. The indicator should continue to show N. If it does not, repeat Steps 2–5.
7. Exit the vehicle and close the door.
8. Lock the doors with the remote key to ensure that the outside handles retract. The vehicle is now ready for the car wash.
9. The vehicle may automatically shift into P (Park) upon re-entry.

Car Wash Mode (Vehicle On) - Driver In Vehicle

To place the vehicle in N (Neutral) with the vehicle on and occupied:

1. Drive to the entrance of the car wash.
2. Apply the brake pedal.
3. Shift to N (Neutral).

4. Release the brake pedal. The vehicle is now ready for the car wash.
5. Lock the doors with the interior lock switch or remote key to ensure that the outside door handles retract. The vehicle is now ready for the car wash.

Car Wash Mode (Vehicle On) - Driver Out of Vehicle

To place the vehicle in N (Neutral) with the vehicle on and unoccupied:

1. Drive to the entrance of the car wash.
2. Apply the brake pedal.
3. Open the door.
4. Shift to N (Neutral), then release the brake pedal.
5. The indicator should continue to show N. If it does not, repeat Steps 2–4.
6. Exit the vehicle and close the door. The vehicle is now ready for the car wash.
7. Lock the doors with the remote key to ensure that the outside handles retract. The vehicle is now ready for the car wash.
8. The vehicle may automatically shift into P (Park) upon re-entry.

D : This position is for normal driving. If more power is needed for overtaking, press the accelerator pedal down.

To shift into D (Drive):

1. Bring the vehicle to a complete stop.
2. From the centre position, move the gear lever rearward toward you and then down.
 - If the vehicle is in P (Park), press the brake pedal while moving the gear lever.
 - D will illuminate red.
3. After releasing the gear lever, it will return to the centre position.

To shift out of D (Drive):

1. Bring the vehicle to a complete stop.
2. Shift to the desired gear.

Caution

Spinning the tyres excessively may damage the electric drive unit. The repair will not be covered by the vehicle warranty. If you are stuck, do not spin the tyres.

When stopping on a steep hill, use the brakes to hold the vehicle in place.

When shifting to P (Park) on a hill, use the brakes to hold the vehicle then shift to P (Park).

One-Pedal Driving

One-Pedal Driving allows the use of the accelerator pedal to control the deceleration of the vehicle to a complete stop. Completely releasing the accelerator pedal will result in aggressive deceleration. Partially lifting off the accelerator pedal allows the deceleration of the vehicle to be adjusted as desired.

Use the brake pedal if emergency braking is required.

To view and configure One-Pedal Driving, from the infotainment display home screen, Select Controls > Drive & Park > One-Pedal Driving.

Select Off to disable One-Pedal Driving for traditional two-pedal driving, similar to a petrol vehicle.

Select On to enable One-Pedal Driving where a moderate level of braking is applied when the accelerator pedal is released while driving.

Select High to enable One-Pedal Driving where a strong level of braking is applied when the accelerator pedal is released while driving.

When enabled, One-Pedal Driving applies in R (Reverse) and D (Drive). This feature remains enabled until manually disabled by the driver. Press the accelerator pedal to the desired speed. The brake lights will come on during substantial deceleration and when the vehicle is stopped.

If One-Pedal Driving is turned off while stopped, the vehicle will stay stopped. Press the brake pedal or accelerator pedal to return to two-pedal driving.

For faster access, One-Pedal Driving can be toggled on the Driver Mode screen. From the infotainment display home screen, select Drive Mode to open the Drive Mode screen.

Touch  to toggle One-Pedal Driving on or off. When turned on, One-Pedal Driving returns to the previously selected level. To change the level, press the Settings link in the pop-up box to go to the full One-Pedal Driving selection.

When possible, One-Pedal Driving uses regenerative braking to slow the vehicle for energy efficiency. Friction brakes may be

used in some cases when regenerative braking is reduced. Friction brakes will be used to hold the vehicle after coming to a stop, and a noise may be noticed when the brakes apply.

When driving on slippery roads, it is recommended to turn off One-Pedal Driving. See *Winter Driving* ⇨ 154.

While using One-Pedal Driving, the Electric Parking Brake may apply in some circumstances. This can occur when:

- The driver exits the vehicle.
- The vehicle has remained stationary for five minutes.

To resume driving, press the accelerator pedal, and the Electric Parking Brake will automatically disengage.

Drive Systems

All-Wheel Drive

This vehicle may be equipped with advanced electric All-Wheel Drive (eAWD). The eAWD system delivers power to all four wheels, and the system adjusts automatically to the driving conditions. The eAWD system continuously varies the drive power to the front and rear wheels to maximise driving

efficiency and improve driving dynamics. Your vehicle has exceptional driving capability, but care must always be taken to adjust driving style to the traffic and road conditions.

The vehicle eAWD settings may be customised for the driver mode selected. See *Driver Mode Control* ⇨ 171 for more information.

Brakes

Electric Brake Boost

Vehicles equipped with electric brake boost have hydraulic brake circuits that are electronically controlled when the brake pedal is applied during normal operation. The system performs routine tests and turns off within a few minutes after the vehicle is turned off. Noise may be heard during this time. If the brake pedal is depressed during the tests or when the electric brake boost system is off, a noticeable change in pedal force and travel may be felt. This is normal.

Antilock Brake System (ABS)

The Antilock Brake System (ABS) helps prevent a braking skid and maintain steering while braking hard.

ABS performs a system check when the vehicle is first driven. A momentary motor or clicking noise may be heard while this test is going on, and the brake pedal may move slightly. This is normal.



If there is a problem with ABS, this warning light stays on. See *Antilock Brake System (ABS) Warning Light* ⇨ 94.

ABS does not change the time needed to put your foot on the brake pedal and does not always decrease stopping distance. If you get too close to the vehicle ahead, there will not be enough time to apply the brakes if it suddenly slows or stops. Always leave enough room ahead to stop, even with ABS.

Using ABS

Do not pump the brakes. Just hold the brake pedal down firmly. Hearing or feeling ABS operate is normal.

Braking in Emergencies

ABS allows steering and braking at the same time. In many emergencies, steering can help even more than braking.

Regional regulations may require tail lights to flash when an emergency brake event is experienced.

Electric Parking Brake

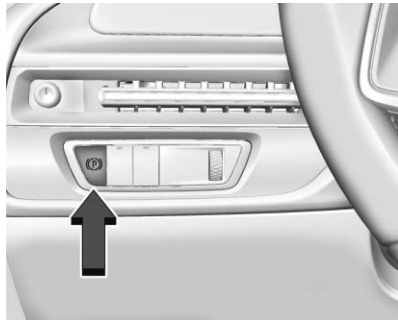

The Electric Parking Brake (EPB) can always be applied, even if the vehicle is switched off. In case of insufficient electrical power, the EPB cannot be applied or released. To prevent draining the battery, avoid unnecessary repeated cycles of the EPB.

The system has a red parking brake status light, and an amber parking brake service warning light. See *Electric Parking Brake Light* ⇨ 94 and *Service Electric Parking Brake Light* ⇨ 94. There are also handbrake-related Driver Information Centre (DIC) messages.

Before leaving the vehicle, check the red handbrake status light to ensure that the handbrake is applied.

EPB Apply

To apply the EPB:

1. Be sure the vehicle is at a complete stop.
2. Press the EPB switch momentarily.

The red handbrake status light will flash and then stay on once the EPB is fully applied. If the red handbrake status light flashes continuously, then the EPB is only partially applied or there is a problem with the EPB. A DIC message will display. Release the EPB and try to apply it again. If the light does not come on, or keeps flashing, have the vehicle serviced. Do not drive the vehicle if the red parking brake status light is flashing, see your Cadillac Service Centre.

If the amber parking brake service warning light is illuminated, press the EPB switch. Continue to hold the switch until the red handbrake status light remains on. If the amber service parking brake warning light is on, see your Cadillac Service Centre.

If the EPB is applied while the vehicle is moving, the vehicle will decelerate as long as the switch is pressed. If the switch is pressed until the vehicle comes to a stop, the EPB will remain applied.

The vehicle may automatically apply the EPB in some situations when the vehicle is not moving. This is normal, and takes place to periodically check the correct operation of the EPB system, or at the request of other safety functions that utilise the EPB.

If the EPB fails to apply, block the rear wheels to prevent vehicle movement.

EPB Release

To release the EPB:

1. Turn the vehicle on.
2. Apply and hold the brake pedal.
3. Press the EPB switch momentarily.

The EPB is released when the red handbrake status light is off.

If the amber parking brake service warning light is illuminated, release the EPB by pressing and holding the EPB switch. Continue to hold the switch until the red handbrake status light is off. If either light stays on after release is attempted, see your Cadillac Service Centre.

Caution

Driving with the parking brake on can overheat the brake system and cause premature wear or damage to brake system parts. Make sure that the parking brake is fully released and the brake warning light is off before driving.

Automatic EPB Release

The EPB will automatically release if the vehicle is running, placed into gear and an attempt is made to drive away. Avoid rapid acceleration when the EPB is applied, to preserve parking brake lining life.

Brake Assist

Brake Assist detects rapid brake pedal applications due to emergency braking situations and provides additional braking to activate the Antilock Brake System (ABS) if the brake pedal is not pushed hard enough

to activate ABS normally. Minor noise, brake pedal pulsation, and/or pedal movement during this time may occur. Continue to apply the brake pedal as the driving situation dictates. Brake Assist disengages when the brake pedal is released.

Hill Start Assist (HSA)

Warning

Do not rely on the HSA feature. HSA does not replace the need to pay attention and drive safely. You may not hear or feel alerts or warnings provided by this system. Failure to use proper care when driving may result in injury, death, or vehicle damage. See *Defensive Driving* ⇨ 151.

When the vehicle is stopped on a grade, Hill Start Assist (HSA) prevents the vehicle from rolling in an unintended direction during the transition from brake pedal release to accelerator pedal apply. The brakes release when the accelerator pedal is applied. The brakes may also release under other conditions. Do not rely on HSA to hold the vehicle.

HSA is available when the vehicle is facing uphill in a forward gear, or when facing downhill in R (Reverse). The vehicle must come to a complete stop on a grade for HSA to activate.

Automatic Vehicle Hold (AVH)



Warning

Do not rely on this feature. It does not replace the need to pay attention and drive safely. You may not hear or feel alerts or warnings provided by this system. Failure to use proper care when driving may result in injury, death, or vehicle damage.

When Automatic Vehicle Hold (AVH) is turned on and the vehicle is braked to a stop, AVH prevents the vehicle from moving during the transition from brake pedal release to accelerator pedal apply. The brakes release when the accelerator pedal is applied. The brakes may also release under other conditions. Do not rely on AVH to hold the vehicle.

If the accelerator pedal is not applied within a few minutes, the Electric Parking Brake will apply. The parking brake will also apply if the driver door is opened or the driver seat belt is unfastened while AVH is holding the vehicle.

AVH can be turned on by pressing AUTO HOLD. The AVH indicator will come on. While AVH is holding the vehicle, the AVH indicator will change to green. See *Automatic Vehicle Hold (AVH) Light* ⇨ 95.

Regenerative Braking

Regenerative braking takes some of the energy from the moving vehicle and turns it back into electrical energy. This energy is then stored back into the high voltage battery system, contributing to increased energy efficiency.

Regenerative power may be limited when the battery is near full charge or cold. See “Regenerative Power Limited” under *Power Indicator Gauge* ⇨ 90. Regenerative braking supplements your vehicle’s conventional brakes, especially when going downhill. See *Hill and Mountain Roads* ⇨ 154.

Warning

Do not charge your vehicle’s battery above an 80% charge if you are going to drive down long, steep gradients such as mountain passes. This provides room in the battery for regenerative braking to supplement your conventional brakes during the descent. This is especially important when towing a trailer, which puts additional stress on your vehicle’s braking system.

See “Charge Now” under *Charging* ⇨ 100 for information on setting charge limits. See *Hill and Mountain Roads* ⇨ 154 for important information about driving on gradients.

The brake system uses regenerative braking, conventional hydraulic braking, or a combination of both as appropriate.

Regen on Demand

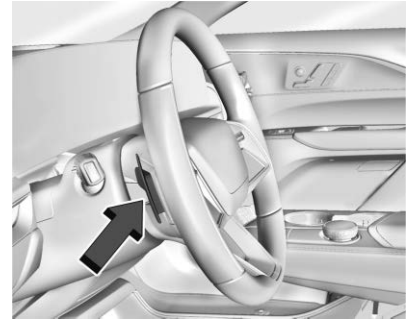

Applying the Regen on Demand steering wheel paddle requests additional deceleration using regenerative braking. The deceleration request increases as the paddle is applied more. It works in D (Drive). The accelerator pedal can be used to manage deceleration while using Regen on Demand. See *One-Pedal Driving* ⇨ 165.

If the vehicle is brought to a complete stop while the Regen on Demand paddle is applied, the vehicle will not creep forward when the paddle is released. The accelerator pedal must be pressed to move the vehicle forward.

If the vehicle is on a steep gradient, the brake pedal must be used to hold the vehicle.

When available regenerative braking power is limited, the hydraulic brakes may be applied to make up the difference.

Cruise control will turn off and the brake lights may come on when this feature is activated.

Avoid using Regen on Demand under slippery road conditions. Use the brake pedal as the primary braking device.

Ride Control Systems

Traction Control/Electronic Stability Control

System Operation

The vehicle has a Traction Control System (TCS) and StabiliTrak/Electronic Stability Control (ESC). These systems help limit wheel spin and assist the driver in maintaining control, especially on slippery road conditions.

TCS activates if it senses any of the drive wheels are spinning or beginning to lose traction. When this happens, TCS applies the brakes to the spinning wheels and reduces vehicle power to limit wheel spin.

StabiliTrak/ESC activates when the vehicle senses a difference between the intended path and the direction the vehicle is actually travelling. StabiliTrak/ESC selectively applies braking pressure to one or more of the vehicle wheel brakes to assist the driver in keeping the vehicle on the intended path. Trailer Sway Control (TSC) is also on automatically when the vehicle is started. See *Trailer Sway Control (TSC)* ⇨ 231.

If cruise control is being used and traction control or StabiliTrak/ESC begins to limit wheel spin, cruise control will disengage. Cruise control may be turned back on when road conditions allow.

Both systems come on automatically when the vehicle is started and begins to move. The systems may be heard or felt while they are operating or while performing diagnostic checks. This is normal and does not mean there is a problem with the vehicle.

It is recommended to leave both systems on for normal driving conditions, but it may be necessary to turn TCS off if the vehicle gets stuck in sand, mud, ice, or snow. See *If the Vehicle Is Stuck* ⇨ 155 and “Turning the Systems Off and On” later in this section.



The indicator light for both systems is in the instrument cluster. This light:

- Flashes when TCS is limiting wheel spin
- Flashes when StabiliTrak/ESC is activated
- Turns on and stay on when either system is not working

See *Traction Control System (TCS)/Electronic Stability Control Light* ⇨ 96.

If either system fails to turn on or to activate, a message displays in the Driver Information Centre (DIC), and  comes on and stays on to indicate that the system is inactive and is not assisting the driver in maintaining control. Adjust driving accordingly.

If  comes on and stays on:

1. Stop the vehicle.
2. Turn the vehicle off and wait 15 seconds.
3. Start the vehicle.
4. Drive the vehicle.

If  comes on and stays on, see your Cadillac Service Centre as soon as possible.



Turning the Systems Off and On

Caution



Do not repeatedly brake or accelerate heavily when TCS is off. The vehicle driveline could be damaged.

To turn Traction (TCS) on and off, in the virtual controls app on the infotainment home screen, select Virtual Controls > DRIVE & PARK > Traction Control. To turn StabiliTrak/ESC on or off, select  next to the Traction Control menu. The following options appear:

- Traction Control Off
- Traction Control and ESC Off
- Traction Control and ESC On

The traction off light  displays in the instrument cluster when the traction control is turned off. When the traction control is turned back on, the traction off light  displayed in the instrument cluster will turn off. See *Traction Off Light* ⇨ 96.

If TCS is actively limiting wheel spin when disabled, the system will not turn off until the wheels stop spinning.

To turn StabiliTrak/ESC off, select  next to the Traction Control menu. Select the Traction Control and ESC Off option. The StabiliTrak/ESC off light  will display in the instrument cluster. See *Electronic Stability Control (ESC) Off Light* ⇨ 97.

TCS cannot be on when StabiliTrak/ESC is off.

StabiliTrak/ESC will automatically turn on if the vehicle exceeds 56 km/h (35 mph) and cannot be turned off again until speed is reduced. Traction control will remain off.

The vehicle has a Trailer Sway Control (TSC) feature and a Hill Start Assist (HSA) feature. See *Trailer Sway Control (TSC)* ⇨ 231 or *Hill Start Assist (HSA)* ⇨ 168.

Adding accessories can affect the vehicle performance. See *Accessories and Modifications* ⇨ 242.

Driver Mode Control

Driver Mode Control allows the driver to adjust the overall driving experience by selecting different modes. Driver Mode Control may be equipped with the following modes: Tour, Sport, Snow/Ice, and a customisable mode: My Mode. These modes adjust multiple systems to suit the specific driving needs. Driver mode availability and affected vehicle subsystems are dependent upon trim level, region, and optional features.

If the vehicle is in Tour mode, My mode, or Sport mode, it will stay in that mode through future on/off cycles. If the vehicle is in any other mode, it will return to Tour mode when the vehicle is restarted. When each mode is selected, a unique and persistent indicator is displayed in the instrument cluster.

Mode Activation

To activate each mode, open the Drive Mode App on the infotainment home screen. Activate each mode by selecting the mode icon.

Mode Descriptions

Tour Mode : Use for normal city and motorway driving to provide a smooth ride. This setting provides a balance between comfort and handling.

Sport Mode : Use where road conditions or personal preference demand a more controlled response. Sport Mode improves vehicle handling and acceleration on dry pavement. When active, Sport Mode modifies steering efforts, pedal tuning, electric vehicle sound enhancement (ESVE), adaptive cruise control, and suspension tuning, if equipped.

Snow/Ice Mode : Use for snow covered roads to improve vehicle acceleration. When active, Snow/Ice mode adjusts pedal tuning to optimise traction on slippery surfaces. This can compromise the acceleration on dry asphalt. Snow/Ice Mode also modifies electric All-Wheel Drive (eAWD) and steering.

This feature is not intended for use when the vehicle is stuck in sand, mud, ice, snow, or gravel. If the vehicle becomes stuck, see *If the Vehicle Is Stuck* ⇨ 155.

My Mode : Use to personalise everyday driving. This mode allows the driver to configure the vehicle subsystem settings to their driving preferences. My Mode remains active across on/off cycles.

Through the infotainment screen, the following vehicle subsystems may be available for customisation in this mode:

Acceleration Feel : Relaxed, Tour, Sport

Brake Feel : Tour, Sport

Steering : Tour, Sport

Suspension : Tour, Sport

Motor Sound : Tour, Sport

For a more detailed description of each selectable option, refer to “Drive Mode Customisation.”

Drive Mode Customization

The vehicle is equipped to modify the following settings based on vehicle content. Through the infotainment home screen, select Settings > Vehicle > Drive Mode Customisation to personalise My Mode.

These settings retain over each on/off cycle, and do not have to be reset each time the vehicle is started.

Acceleration Feel : Choose how responsive you want acceleration to feel. You can adjust the accelerator pedal to provide increased power.

Brake Feel : Brake response settings adjust the brake pedal response. Brake pedal feel is less sensitive at lower settings and more sensitive at higher settings.

Motor Sound : Customise how your vehicle sounds when you are accelerating. Your electric motor remains quiet outside but the sound you hear inside changes as you drive faster or slower.

Steering : Choose how responsive you want the steering to feel. You can set the steering wheel to provide more feedback, which requires more steering effort.

Suspension : Choose how responsive you want the suspension to feel. You can make the suspension stiffer or more comfortable.

Cruise Control

Adaptive Cruise Control (Advanced)

If equipped, Adaptive Cruise Control (ACC) allows the cruise control set speed and following gap to be selected. Read this entire section before using this system. The following gap is the following time (or distance) between your vehicle and a vehicle detected directly ahead in your path, moving in the same direction. If no vehicle is detected in your path, ACC works like regular cruise control. ACC uses a camera and radar sensor(s) to detect other vehicles.

If a vehicle is detected in your path, ACC can apply acceleration or limited, moderate braking to maintain the selected following gap. To disengage ACC, apply the brake. If ACC is controlling the vehicle speed when the Traction Control System (TCS) or StabiliTrak/Electronic Stability Control (ESC) system activates, ACC may automatically disengage. See *Traction Control/Electronic Stability Control* ⇨ 170. When road conditions allow ACC to be safely used, ACC can be turned back on.

Disabling the TCS or StabiliTrak/ESC system will disengage and prevent engagement of ACC.

ACC can reduce the need for you to frequently brake and accelerate, especially when used on expressways, dual carriageways and motorways. When used on other roads, you may need to take over the control of braking or acceleration more often.

Warning

ACC has limited braking ability and may not have time to slow the vehicle down enough to avoid a collision with another vehicle you are following. This can occur when vehicles suddenly slow or stop ahead, or enter your lane. Also see “Alerting the Driver” later in this section. Complete attention is always required while driving and you should be ready to take action and apply the brakes. See *Defensive Driving* ⇨ 151.

Warning

ACC will not detect or brake for children, pedestrians, animals, or other objects.

Do not use ACC when:

- On winding and hilly roads or when the camera sensor is blocked by snow, ice, or dirt. The system may not detect a vehicle ahead. Keep the windshield and headlights clean.
- When visibility is poor due to rain, snow, mist, dirt, insect residue, or dust; when other foreign objects obscure the camera's view; or when the vehicle in front or oncoming traffic causes additional environmental obstructions, such as road spray. ACC performance is limited under these conditions.
- On slippery roads where fast changes in tyre traction can cause excessive wheel slip
- With extremely heavy cargo loaded in the cargo area or rear seat
- When towing a trailer

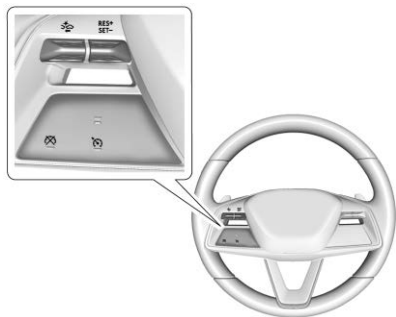

 : Press to turn the system on or off. The indicator turns white on the instrument cluster when ACC is turned on.

RES+ : Press briefly to resume the previous set speed or to increase vehicle speed if ACC is already activated. To increase speed by about 1 km/h (1 mph), press RES+ to the first detent. To increase speed to the next 5 km/h (5 mph) mark on the speedometer, press RES+ to the second detent.

SET- : Press briefly to set the speed and activate ACC or to decrease vehicle speed if ACC is already activated. To decrease speed by about 1 km/h (1 mph), press SET- to the first detent. To decrease speed to the next 5 km/h (5 mph) mark on the speedometer, press SET- to the second detent.

 : Press to disengage ACC without erasing the selected set speed.

 : Press to select a following gap setting for ACC of Far, Medium, or Near.

The speedometer reading can be displayed in either English or metric units. See *Instrument Cluster* ⇨ 87. The increment value used depends on the units displayed.

Switching Between ACC and Regular Cruise Control



To switch between ACC and regular cruise control, press and hold . A Driver Information Centre (DIC) message displays. See *Vehicle Messages* ⇨ 110.



ACC Indicator (Base Level) ACC Indicator (Uplevel)



Regular Cruise Control Indicator

When ACC is engaged, a green  indicator will be lit on the instrument cluster and the following gap will be displayed. When the regular cruise control is engaged, a green  indicator will be lit on the instrument cluster; the following gap will not display.

Switching from ACC to regular cruise control is only recommended when there are no vehicles ahead of your vehicle.

When the vehicle is turned on, the cruise control mode will be set to the last mode used before the vehicle was turned off.

Warning



Always check the cruise control indicator on the instrument cluster to determine which mode cruise control is in before using the feature. If ACC is not active, the vehicle will not automatically brake for

(Continued)

Warning (Continued)

other vehicles, which could cause a crash if the brakes are not applied manually. You and others could be seriously injured or killed.

Setting Adaptive Cruise Control

If  is on when not in use, it could get pressed and go into ACC when not desired. Keep  off when cruise is not being used.

Select the set speed desired for ACC. This is the vehicle speed when no vehicle is detected in your path.

While the vehicle is moving, ACC will not set at a speed below a minimum speed, although it can be resumed. If equipped with Super Cruise, this minimum speed is 5 km/h (3 mph), otherwise, it is 25 km/h (15 mph). The minimum allowable set speed is 25 km/h (15 mph).

To set ACC while moving:

1. Press .
2. Get up to the desired speed.
3. Press and release SET-.
4. Remove foot from the accelerator pedal.

After ACC is set, it may immediately apply the brakes if a vehicle ahead is detected closer than the selected following gap.

ACC can also be set while the vehicle is stopped if ACC is on and the brake pedal is applied.



The ACC indicator displays on the instrument cluster and Head-Up Display (HUD), if equipped. When ACC is turned on, the indicator will be lit white. When ACC is engaged, the indicator will be lit green.

Be mindful of speed limits, surrounding traffic speeds, and weather conditions when selecting the set speed.

Resuming a Set Speed

If the ACC is set at a desired speed and then the brakes are applied, ACC is disengaged without erasing the set speed from memory.

To begin using ACC again, press RES+ up briefly.

If the vehicle is travelling at more than 5 km/h (3 mph), it returns to the previous set speed.

If the vehicle is stopped with the brake pedal applied, press RES+ and release the brake pedal. ACC will hold the vehicle until RES+ or the accelerator pedal is pressed.

A green ACC indicator and the set speed display on the instrument cluster. The vehicle ahead indicator may be flashing if a vehicle ahead was present and moved. See “Approaching and Following a Vehicle” later in this section.

Once ACC has resumed, the vehicle speed will increase to the set speed under the following conditions:

- There is no vehicle ahead.
- The vehicle ahead is beyond the selected following gap.
- The vehicle speed is not being limited because of a sharp turn.

Increasing Speed While ACC Is at a Set Speed

If ACC is already activated, do one of the following:

- Use the accelerator to get to the higher speed. Briefly press and release SET- and release the accelerator pedal. The vehicle

will now cruise at the higher speed. When the accelerator pedal is pressed, ACC will not brake because it is overridden. While overridden, the ACC indicator will turn blue on the instrument cluster and HUD.

- Press and hold RES+ until the desired set speed is displayed, then release it.
- To increase speed in smaller increments, press RES+ to the first detent. For each press, the vehicle goes about 1 km/h (1 mph) faster.
- To increase speed in larger increments, press RES+ to the second detent. For each press, the vehicle speed increases to the next 5 km/h (5 mph) mark on the speedometer.

The set speed can also be increased while the vehicle is stopped if:

- stopped with the brake pedal applied, press RES+ until the desired set speed is displayed.
- ACC is holding the vehicle at a stop and there is another vehicle directly ahead, pressing RES+ will increase the set speed.

- and when pressing RES+ there is no longer a vehicle ahead or the vehicle ahead is pulling away and the brake is not applied with cause the ACC to resume.

When it is determined that there is no vehicle ahead or the vehicle ahead is beyond the selected following gap, then the vehicle speed will increase to the set speed.

Reducing Speed While ACC Is at a Set Speed

If ACC is already activated, do one of the following:

- Use the brake to get to the desired lower speed. Release the brake and press SET-. The vehicle will now cruise at the lower speed.
- Press and hold SET- until the desired lower speed is reached, then release it.
- To decrease the vehicle speed in smaller increments, press SET- to the first detent. For each press, the vehicle goes about 1 km/h or (1 mph) slower.
- To decrease the vehicle speed in larger increments, press SET- to the second detent. For each press, the vehicle speed decreases to the next 5 km/h (5 mph) mark on the speedometer.

The set speed can also be decreased while the vehicle is stopped.

If stopped with the brake applied, press or hold SET- until the desired set speed is displayed.

Selecting the Follow Distance Gap

When a slower moving vehicle is detected ahead within the selected following gap, ACC will adjust the vehicle's speed and attempt to maintain the follow distance gap selected.

Press  on the steering wheel to adjust the following gap. Each press cycles the gap button through three settings: Far, Medium, or Near.

When pressed, the current gap setting displays briefly on the instrument cluster and HUD (if equipped). The gap setting will be maintained until it is changed.

Gap Adjust



Far Gap Setting

Gap Adjust



Medium Gap Setting

Gap Adjust





Near Gap Setting

Since each gap setting corresponds to a following time (Far, Medium, or Near), the following distance will vary based on vehicle speed. The faster the vehicle speed, the further back your vehicle will follow a vehicle detected ahead. Consider traffic and weather conditions when selecting the following gap. The range of selectable gaps may not be appropriate for all drivers and driving conditions.

Changing the gap setting automatically changes the alert timing sensitivity (Far, Medium, or Near) for the Forward Collision Alert (FCA) feature. See *Forward Collision Alert (FCA) System* ⇨ 196.

Courtesy Gap

Press and hold  on the steering wheel when vehicle is moving to temporarily increase the gap with the vehicle ahead to allow for merging traffic.

Press and hold  when stopped to cancel ACC from resuming automatically (if the stop is brief) and to remain stationary. This can be used to allow traffic to merge between you and the vehicle ahead. Press RES+ or the accelerator pedal to resume ACC.

Following distance gap will return to the original selection after hold.

Alerting the Driver

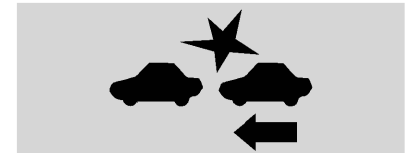

If ACC is engaged, driver action may be required when ACC cannot apply sufficient braking because of approaching a vehicle too rapidly.

When this condition occurs, the collision alert symbol will flash on the windscreen. Either eight beeps will sound from the front, or both sides of the Safety Alert Seat will pulse five times. Touch the Settings icon on the infotainment home page. Select “Vehicle” to display the list of available options and select “Collision/Detection Systems”.

See *Defensive Driving* ⇨ 151.

Approaching and Following a Vehicle



The vehicle ahead indicator is in the instrument cluster and HUD (if equipped). It only displays when a vehicle is detected in your vehicle’s path moving in the same direction. If this symbol is not displaying, ACC will not respond to or brake for vehicles ahead.

ACC automatically slows the vehicle down and adjusts vehicle speed to follow a detected vehicle ahead at the selected following gap. The vehicle speed increases or

decreases to follow a detected vehicle in front of your vehicle when that vehicle is traveling slower than your vehicle set speed. It may apply limited braking, if necessary. When braking is active, the brake lamps will come on. The automatic braking may feel or sound different than if the brakes were applied manually. This is normal.

Overtaking a Vehicle While Using ACC

If the set speed is high enough, and the left indicator is used to overtake a vehicle ahead within the selected interval, ACC may assist by gradually accelerating the following vehicle prior to the lane change.

Warning

When using ACC to overtake a vehicle or change lane, the distance to the vehicle ahead being overtaken may be reduced. ACC may not apply sufficient acceleration or braking when overtaking a vehicle or changing lane. Always be ready to accelerate or brake manually to finish overtaking or changing lane.

Stationary or Very Slow-Moving Objects

Warning

ACC may not detect and react to stopped or slow-moving vehicles ahead of you. For example, the system may not brake for a vehicle it has never detected moving. This can occur in stop-and-go traffic or when a vehicle suddenly appears due to a vehicle ahead changing lanes. Your vehicle may not stop and could cause a crash. Use caution when using ACC. Your complete attention is always required while driving and you should be ready to take action and apply the brakes.

Irregular Objects Affecting ACC

ACC may have difficulty detecting the following objects:

- Vehicles with cargo extending from the rear.
- Non-standard shaped vehicles, such as vehicle transport, vehicles with a side car fitted, or horse-drawn carriages.
- Objects that are close to the front of your vehicle.

ACC Automatically Disengages

ACC may automatically disengage and the driver will need to manually apply the brakes to slow the vehicle if:

- The sensors are blocked.
- The Traction Control System (TCS) or StabiliTrak/ESC system has activated or been disabled.
- There is a fault in the system.
- The radar falsely reports blockage when driving in a desert or remote area with no other vehicles or roadside objects.
- A DIC message may display to indicate that ACC is temporarily unavailable.

The ACC indicator will turn white when ACC is no longer active.

In some cases, when ACC is temporarily unavailable, regular cruise control may be used. See “Switching Between ACC and Regular Cruise Control” previously in this section. Always consider driving conditions before using either cruise control system.

Notification to Resume ACC

ACC will maintain a follow gap behind a detected vehicle and slow your vehicle to a stop behind that vehicle.

If the stopped vehicle ahead has driven away and ACC has not resumed, the vehicle ahead indicator will flash as a reminder to check traffic ahead before proceeding. In addition, the left and right sides of the Safety Alert Seat will pulse three times, or three beeps will sound. Touch the Settings icon on the infotainment home page. Select “Vehicle” to display the list of available options and select “Alert Type” and “Adaptive Cruise Go Notifier” in “Collision/Detection Systems”.

When the vehicle ahead drives away, and if the stop was brief, ACC resumes automatically. If necessary, press RES+ or the accelerator pedal to resume ACC. If stopped for more than two minutes or if the driver door is opened and the driver seat belt is unfastened, the ACC automatically applies the Electric Parking Brake (EPB) to hold the vehicle. The EPB status light will turn on. See *Electric Parking Brake* ⇨ 167.

A DIC warning message may display indicating to shift to P (Park) before exiting the vehicle. See *Vehicle Messages* ⇨ 110.

Warning

If ACC has stopped the vehicle, and if ACC is disengaged, turned off, or cancelled, the vehicle will no longer be held at a stop. The vehicle can move. When ACC is holding the vehicle at a stop, always be prepared to manually apply the brakes.

Warning

Leaving the vehicle without placing it in P (Park) can be dangerous. Do not leave the vehicle while it is being held at a stop by ACC. Always place the vehicle in P (Park) and turn it off before leaving the vehicle.

ACC Override

If using the accelerator pedal while ACC is active, the ACC indicator turns blue on the instrument cluster and in the HUD (if equipped) indicating ACC braking will not occur. ACC will resume operation when the accelerator pedal is not being pressed.

Warning

The ACC will not automatically apply the brakes if your foot is resting on the accelerator pedal. You could crash into a vehicle ahead of you.

Bends in the Road

Warning

On bends, ACC may not detect a vehicle ahead in your lane. You could be startled if the vehicle accelerates up to the set speed, especially when following a vehicle exiting or entering exit ramps. You could lose control of the vehicle or crash. Do not use ACC while driving on an entrance or exit ramp. Always be ready to use the brakes if necessary.

Warning

On bends, ACC may respond to a vehicle in another lane, or may not have time to react to a vehicle in your lane. You could crash into a vehicle ahead of you, or lose control of your vehicle. Give extra

(Continued)

Warning (Continued)

attention in bends and be ready to use the brakes if necessary. Select an appropriate speed while driving in bends.

ACC may operate differently in a sharp bend. It may briefly reduce the vehicle speed if the bend is too sharp.

The bend speed control indicator  may illuminate green when ACC is actively controlling the vehicle speed and detects a sharp bend on the road ahead.

ACC automatically slows the vehicle while navigating a bend and may increase speed out of the bend, but will not exceed the set speed.

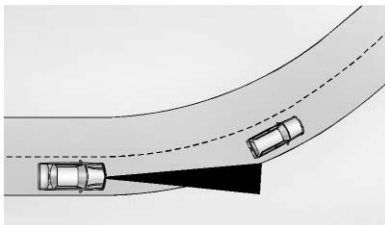

When following a vehicle and entering a bend, ACC may not detect the vehicle ahead and accelerate to the set speed. When this happens, the vehicle ahead indicator will not appear.

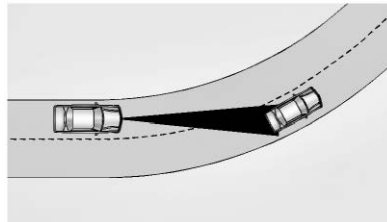

ACC may detect a vehicle that is not in your lane and apply the brakes.

ACC may occasionally provide an alert and/or braking that is considered unnecessary. It could respond to vehicles in different lanes or stationary objects when entering or exiting a bend. This is normal operation. The vehicle does not need service.

Other Vehicle Lane Changes

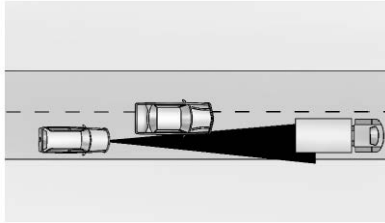

ACC will not detect a vehicle ahead until it is completely in the lane. The brakes may need to be manually applied.

Objects Not Directly in Front of Your Vehicle

The detection of objects in front of the vehicle may not be possible if:

- The vehicle or object ahead is not within your lane.
- The vehicle ahead is shifted, not centred, or is shifted to one side of the lane.

Driving in Narrow Lanes

Vehicles in adjacent traffic lanes or roadside objects may be incorrectly detected when located along the roadway.

Do Not Use ACC on Hills

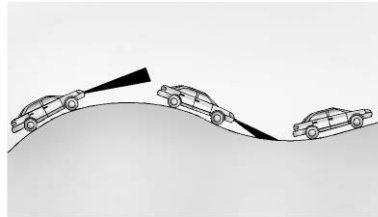



Do not use ACC when driving on steep hills. ACC will not detect a vehicle ahead.

Do Not Use ACC When Towing a Trailer

ACC should not be used when towing a trailer.

Disengaging ACC

There are four ways to disengage ACC:

- Step lightly on the brake pedal.
- Press .
- Press .
- Press the Regen On Demand paddle.

Erasing Speed Memory

The ACC set speed is erased from memory if  is pressed or if the vehicle is turned off.

Auto Set Speed

The Auto Set Speed function uses detected road speed limits to assist setting the vehicle speed while ACC is engaged.

You can enable or disable this feature through vehicle settings. To view available settings from the infotainment screen, touch Settings > Vehicle > Collision/Detection Systems.

Auto Set Speed will remain enabled or disabled until another selection is made, even if the vehicle is turned off and on.

When ACC is engaged and Auto Set Speed is enabled, the vehicle will:

- use the road speed limit to maintain a set vehicle speed.
- prompt you to accept or decline speed limit changes, when detected.
- change the ACC set speed to match the new road speed limit, if accepted when prompted.
- not make any changes, if declined when prompted.
- change ACC set speed to the new road speed limit if no action is taken after receiving a prompt.

Increase or decrease ACC set speed at any time using the SET- or RES+ buttons, to a predefined limit. The accelerator pedal can also be used to override the set speed.

The change in the amount of increased or decreased speed, known as an offset, is stored and applied for next speed limit change. There is a predefined maximum allowed value of the offset, beyond which set speed cannot be changed.

The offset will not be retained if ACC is disengaged, Auto Set Speed has been turned off, or if vehicle is turned off.

This function will not work when regular Cruise Control is the selected Cruise Control mode.

This function may not work for conditional speed limit signs, for example, during specific times or where workers are present.

Weather Conditions Affecting ACC

System operation may be limited in snow, heavy rain, or road spray conditions.

Accessory Installations and Vehicle Modifications

Do not install or place any object around the front camera windscreen area that would obstruct the front camera view.

Do not install objects on top of the vehicle that overhang and obstruct the front camera, such as a canoe, kayak, or other items that can be transported.

Do not modify the bonnet, headlights, or fog lights, as this may limit the camera's ability to detect an object.

Do not attach anything to the front or rear fascia as this may interfere with the radar sensor operation.

Warning

Stickers or accessories attached on or around the front or rear fascia of your vehicle can impair the radar sensors resulting in vehicle damage or personal injury. Your vehicle could brake suddenly. Do not attach anything on or around the front or rear fascia, including the number plate, the bumper, or the grille. Use only GM genuine accessories.

Cleaning the Sensing System

The camera sensor on the windscreen behind the rear-view mirror, and the sensors on the front of the vehicle can become

blocked by snow, ice, dirt, mud, or debris. This area needs to be cleaned for ACC to operate properly.

If ACC will not operate, regular cruise control may be available. See “Switching Between ACC and Regular Cruise Control” previously in this section. Always consider driving conditions before using either cruise control system.

For cleaning instructions, see “Washing the Vehicle” under *Exterior Care* ⇨ 280.

Advanced Driver Assistance Systems

This vehicle may have features that work together to help avoid crashes or reduce crash damage while driving, reversing, and parking. Read this entire section before using these systems.

Warning

Do not rely on the Driver Assistance Systems. These systems do not replace the need for paying attention and driving safely. You may not hear or see alerts or warnings provided by these systems.

(Continued)

Warning (Continued)

Failure to use proper care when driving may result in injury, death, or vehicle damage. See *Defensive Driving* ⇨ 151.

Under many conditions, these systems will not:

- Detect children, pedestrians, bicyclists, or animals.
- Detect vehicles or objects outside the area monitored by the system.
- Work at all driving speeds.
- Warn you or provide you with enough time to avoid a crash.
- Work under poor visibility or bad weather conditions.
- Work if the detection sensor is not cleaned or is covered by ice, snow, mud, or dirt.
- Work if the detection sensor is covered up, such as with a sticker, magnet, or metal plate.
- Work if the area surrounding the detection sensor is damaged or not properly repaired.

(Continued)

Warning (Continued)

Complete attention is always required while driving, and you should be ready to take action and apply the brakes and/or steer the vehicle to avoid crashes.

⚠ Warning

Stickers or accessories attached on or around the front or rear fascia of your vehicle can impair the radar sensors resulting in vehicle damage or personal injury. Your vehicle could brake suddenly. Do not attach anything on or around the front or rear fascia, including the number plate, the bumper, or the grille. Use only GM genuine accessories.

Audible Alert or Safety Alert Seat

Some driver assistance features alert the driver of obstacles by beeping. To view available settings from the infotainment screen, touch Settings > Vehicle > Comfort and Convenience.

If equipped with the Safety Alert Seat, the driver seat cushion may provide a vibrating pulse alert instead of beeping. To view

available settings from the infotainment screen, touch Settings > Vehicle > Collision/Detection Systems.

Cleaning

Depending on vehicle options, keep these areas of the vehicle clean to ensure the best driver assistance feature performance. Driver Information Centre (DIC) messages may display when the systems are unavailable or blocked.





- Front and rear bumpers and the area below the bumpers
- Front grille and headlights
- Front camera lens in the front grille or near the front emblem
- Front side and rear side panels
- Outside of the windscreen in front of the rearview mirror
- Side camera lens on the bottom of the outside mirrors
- Rear side corner bumpers
- Rear Vision Camera above the license plate

Assistance Systems for Parking or Reversing

If equipped, the Rear Vision Camera (RVC), Rear Park Assist (RPA), Surround Vision, Side Bicycle Detection, and Rear Cross Traffic Alert (RCTA) may help the driver park or avoid objects. Always check around the vehicle when parking or backing.

Rear Vision Camera (RVC)

When the vehicle is shifted into R (Reverse), the RVC displays an image of the area behind the vehicle in the infotainment display. The previous screen displays when the vehicle is shifted out of R (Reverse) after a short delay. To return to the previous screen sooner, press  on the centre console, shift into P (Park), or reach a vehicle speed of approximately 12 km/h (8 mph).

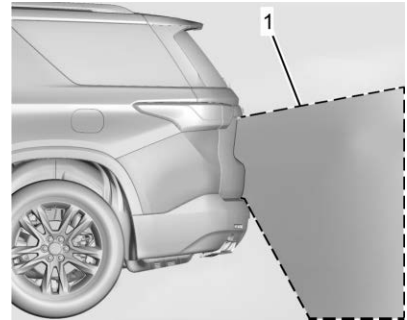

1. View Displayed by the Camera

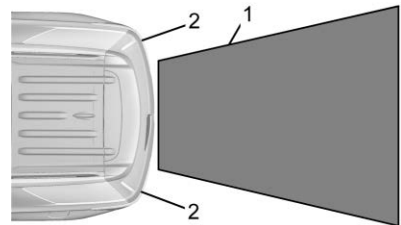

1. View Displayed by the Camera
2. Corners of the Rear Bumper

Displayed images may be farther or closer than they appear. The area displayed is limited and objects that are close to either corner of the bumper or under the bumper do not display.

A warning triangle may display to show that RPA has detected an object. This triangle changes from amber to red and increases in size the closer the object.

If  or a service message appears on the infotainment display, there may be a camera malfunction. See your Cadillac Service Centre.

Warning

The camera(s) do not display children, pedestrians, bicyclists, crossing traffic, animals, or any other object outside of the cameras' field of view, below the bumper, or under the vehicle. Shown distances may be different from actual distances. Do not drive or park the vehicle using only these camera(s). Always check behind and around the vehicle before driving. Failure to use proper care may result in injury, death, or vehicle damage.

Surround Vision System

If equipped, Surround Vision displays an image of the area surrounding the vehicle, along with the front or rear camera views on the infotainment display. The front camera is in the grille or near the front emblem, the side cameras are on the bottom of the outside mirrors, and the rear camera is above the number plate.

The Surround Vision system can be accessed by selecting CAMERA in the infotainment display or when the vehicle is shifted into R (Reverse). To return to the previous screen sooner, when not in R (Reverse) press Home or Back on the infotainment system, change to P (Park), or reach a vehicle speed of approximately 12 km/h (8 mph) while in D (Drive).

Warning

The Surround Vision Cameras have blind spots and will not display all objects near the corners of the vehicle. Folding side mirrors that are out of position will not display surround view correctly. Always check around the vehicle when parking or backing.



1. Views Displayed by the Surround Vision Cameras
2. Area Not Shown

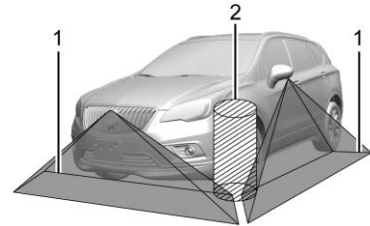

1. Views Displayed by the Surround Vision Cameras
2. Area Not Shown

Warning

The camera(s) do not display children, pedestrians, bicyclists, crossing traffic, animals, or any other object outside of the cameras' field of view, below the bumper, or under the vehicle. Shown distances may be different from actual distances. Do not drive or park the vehicle using only these camera(s). Always check behind and around the vehicle before driving. Failure to use proper care may result in injury, death, or vehicle damage.

Camera Views

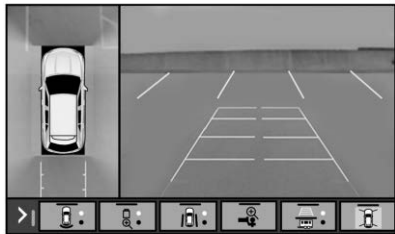

Touch the camera view buttons along the bottom of the infotainment display.

Front/Rear Standard View : Displays an image of the area in front or behind the vehicle. Touch Front/Rear Standard View on the infotainment display when a camera view is active. Touching the button multiple times will toggle between front and rear camera views.

If equipped, the front view camera also displays when the Park Assist system detects an object within 30 cm (12 in).

Front/Rear Overhead View : Displays a front or rear overhead view of the vehicle. Touching the button will toggle between the two views.

Side Forward/Rearward View : Displays a view that shows objects next to the front or rear sides of the vehicle. Touch Side Forward/Rearward View on the infotainment display when a camera view is active. Touching the button multiple times will toggle between forward and rearward views. Park Assist and Rear Cross Traffic Alert overlays are not available when Side Forward/Rearward view is active.

Camera App Guidance Lines : The Camera App supports three possible guidance modes: No Guidance, Vehicle Guidance and Trailing Guidance. The Guidance Lines Icon may appear as a selection on the screen when a view supports guidance lines. To change the guidance mode, select the appropriate guidance icon. Depending on the guidance mode and view selected, different guidance lines may appear. A greyed-out icon indicates that guidance lines are not available. Certain views do not support guidance lines.

Top Down View : Displays an image of the area surrounding the vehicle, along with the rear camera view in the infotainment display. The rear camera view will be replaced by the front camera view after shifting from R (Reverse) to a forward gear, or when the vehicle is moving forward slower than approximately 12 km/h (8 mph).

Hitch View

Displays a zoomed-in view of the hitch area to assist with aligning the vehicle's hitch ball with the trailer coupler and monitoring the trailer connection. To view, select Hitch View on the infotainment display when the Camera App is active. The view can be closed by selecting X, Home or Back on the

infotainment display. Shifting into P (Park) while in this view will automatically engage the Electric Parking Brake (EPB).

Park Assist

The vehicle may be equipped with Front and Rear Park Assist (FRPA). Under certain conditions, the Park Assist system can assist the driver during reversing and parking manoeuvres when the vehicle is driven at no more than 9 km/h (6 mph). An illuminated indicator in the Park Assist button indicates the system is ready.

Sensors located in the bumpers measure the distance between the vehicle and objects using sonar technology. These sensors are designed to detect certain objects up to 2.5 m (8 ft) behind and 1.2 m (4 ft) in front of your vehicle that are taller than 25 cm (10 in).

Different environmental conditions may affect whether and how far away the Park Assist system can detect objects. Keep the sensors clean of mud, dirt, snow, ice, and slush; and clean sensors after a car wash in freezing temperatures. Sensors that are not clean may not detect objects or may cause the system to alert when not required.

Warning

The Park Assist System is no substitute for careful and attentive driving. The Park Assist system does not detect children, pedestrians, cyclists, animals, or objects located below the bumper or that are too close or too far from the vehicle. It is not available at speeds greater than 9 km/h (6 mph). To prevent injury, death, or vehicle damage, even with Park Assist, always check the area around the vehicle and check all mirrors before moving forward or reversing.

How the System Works

The vehicle may have a Park Assist amphitheatre-like display on the cluster with bars that represent the estimated location of a detected object and the vehicle's distance from the object. As a detected object gets closer, more bars light up and change colour from yellow to amber to red.

When an object is first detected in the rear, one beep will be heard from the rear, or the driver's seat will pulse two times, if equipped with Safety Alert Seat. When an object is very close, five beeps will sound

from the front or rear (depending on the object's location), or the driver's seat will pulse five times. Beeps for front are higher pitched than the rear.

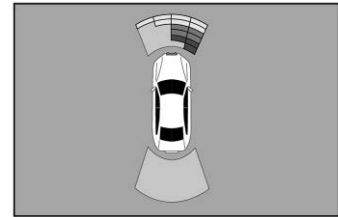

Turning the System On and Off

The Park Assist System can be turned on or off using the infotainment system. To view available settings from the infotainment home screen, touch Settings > Vehicle > Collision/Detection Systems.

The  button is used to turn on or off the Park Assist, which also turns the Reversing Warning and Reverse Automatic Braking (RAB) on or off at the same time. When the system is turned off, a system off message is shown on the display. This message disappears after a short period of time.

Turn off Park Assist when towing a trailer and when a bike rack is attached to prevent unwanted beeps and to ensure proper operation.

When the System Does Not Seem to Work Properly

If a service message displays, check the following conditions:

- The sensors may not be clean. Keep the vehicle's front and rear bumpers free of mud, dirt, snow, ice and slush. For cleaning instructions, see *Exterior Care* ⇨ 280.
- The Park Assist sensors may be covered by frost or ice. Frost or ice can form around and behind the sensors and may not always be seen; this can occur after washing the vehicle in cold weather. The message may not clear until the frost or ice has melted.

If a service message displays and the above conditions do not exist, take the vehicle to your Cadillac Service Centre for repairs.

If the Park Assist System does not activate due to a temporary condition, a system off message is shown on the display. This can occur under the following conditions:

- The driver has disabled the system.

- An object is currently blocking the rear sensors (for example, bike rack, tailgate, trailer hitch, etc.). Once the object is removed, Park Assist will return to normal operation.
- The bumper is damaged. Take the vehicle to your Cadillac Service Centre for repairs.
- Other conditions, such as vibrations from a jackhammer or the compression of air brakes on a very large truck, are affecting system performance.

Automatic Parking Assist (APA)

Enhanced Automatic Parking Assist (APA)

If equipped, under certain conditions APA with Braking can use sensors based on sonar technology along the vehicle's front, rear and sides to detect a parking space, and automatically park or unpark the vehicle with some driver assistance. The vehicle will automatically manoeuvre into a detected spot moving at or near idle speed. It does this by automatically steering, braking, accelerating, and gear shifting. The driver must always be prepared to apply braking or additional acceleration, as needed.

A display and audible beeps help to guide the parking manoeuvres.

Warning

APA may not always detect objects in the parking space, objects that are not rigid (e.g. shrubs and chain-link fences), objects below the bumper, objects high off the ground (e.g. flatbed trucks), hanging objects, objects below ground level (e.g. large potholes), or moving objects (e.g. pedestrians, cyclists, vehicles). Always verify that the parking space is appropriate for parking a vehicle. APA may not respond to changes in the parking space, such as the movement of an adjacent vehicle, or a person or object entering the parking space. APA does not detect or avoid traffic that is behind or alongside the vehicle. Always be prepared to stop the vehicle during the parking manoeuvre.

How to Activate Automatic Parking

To activate APA, press  on the infotainment screen for the system to begin searching for a parking space while driving forward at no greater than 30 km/h (18 mph). APA searches for parking spaces, to the left or right of the vehicle, up to the sensors' ranges of 1.5 m (5 ft). To

search for a parking space to the left, turn on the left indicator or, if available, change the side selection in the infotainment display. To choose or change the parking mode, make a selection on the infotainment display.

APA cannot park in all empty parking spots. The parking spot must:

- Be sufficiently large to fit the vehicle comfortably.
- Have an adjacent vehicle, wall, or pillar for the system to align to.



After completely passing an eligible parking space, a beep sounds and a notification to stop the vehicle is displayed in the driver information centre. Generally, APA selects the nearest empty parking spot behind the vehicle, but under some conditions may

select a space that is further back. Slow down and bring the vehicle to a complete stop to begin.

Follow the displayed instructions. When the vehicle is ready to begin the manoeuvre, the steering wheel will vibrate briefly as a reminder to remove hands from the steering wheel. After the vibration stops, check your surroundings and release the brakes to begin automatic parking. As the vehicle automatically steers, brakes, accelerates, and shifts gears into the parking space, continue to check your surroundings. Be prepared to stop to avoid vehicles, pedestrians, or objects.

A progress bar displays the status of the parking manoeuvre. Once automatic parking is finished and the vehicle has come to a full stop, APA will beep and display a message indicating parking is complete.

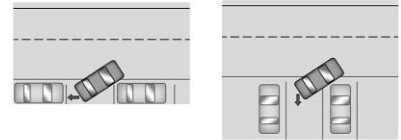

Automatic Parking

How to Activate Automatic Unparking

To activate APA, press **P**  on the infotainment screen after turning the vehicle on and leaving it in P (Park). A screen will be displayed with unparking options. Similar to automatic parking, follow the displayed instructions and check surroundings as the vehicle un parks.

Once automatic unparking is finished and the vehicle has come to a full stop, FINAL POSITION - PRESS BRAKES will display. Press and hold the brakes. APA will beep and display TAKE CONTROL. The vehicle is now ready to exit the parking space free of obstructions. Take control to drive away.

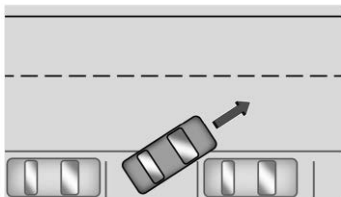

Automatic Unparking

How to Cancel Automatic Parking/Unparking

To cancel automatic parking or automatic unparking at any time, press **P** or **X** on the infotainment display. Be prepared to resume full control of the vehicle. APA holds the vehicle until the parking brake or brake is applied, or the vehicle is shifted into P (Park). To start driving away, press the brakes and change to D (Drive).

Certain vehicle conditions and driver interference may also cancel automatic parking:

- The driver manually steers the vehicle.
- The maximum allowed speed is exceeded.
- There is a failure with the APA system.
- Electronic stability control or antilock brakes are activated.

- The parking brake is applied.
- Driver unbuckles the seat belt and opens the door.

System Limitations

Automatic Parking Assist has certain limitations. The system cannot:

- Continue to operate if the manoeuvre speed exceeds 5 km/h (3 mph).
- Detect whether a parking space is legal or restricted.
- Detect pavement markings or lines.
- Park the vehicle closely lined up with the vehicle next to it, particularly if the spot is approached at an angle or if the parking space is angled.
- Park exactly centred in a very large spot.
- Always detect short curbs.
- Operate while towing any trailer.

When the System Does Not Seem to Work Properly

If the vehicle does not reverse into the expected parking space, the system could be manoeuvring the vehicle into a previously detected space.

Remote Auto Parking

If equipped, the vehicle can complete the automatic parking manoeuvres while the driver authorises the manoeuvre via the myCadillac app on a compatible mobile phone outside of the vehicle. The driver can also activate an automatic parallel or perpendicular unparking manoeuvre via the myCadillac app. The driver must always be prepared to cancel the automatic manoeuvre if necessary.

Remote Auto Parking works the same way and has the same limitations as the standard APA feature described above. The main difference is that you must instead exit the vehicle and use the myCadillac app.

Warning

When using the remote parking feature, stay within a short distance and visually monitor the vehicle until parking is complete. Do not leave the vehicle unsupervised during remote parking.

How to Activate Remote Auto Parking

To activate Remote Auto Parking, press **P** on the infotainment screen for the system to begin searching for a parking space while

driving forward at no greater than 30 km/h (18 mph). APA searches for parking spaces to the left or right of the vehicle up to the sensors' ranges of 1.5 m (5 ft). To choose or change the parking mode or side, make a selection in the infotainment display.

After completely passing an eligible parking space, a beep sounds and a notification to stop the vehicle is displayed in the driver information centre. Generally, Remote Auto Parking selects the nearest empty parking space behind the vehicle, but under some conditions may select a space that is further back. Slow down and bring the vehicle to a complete stop to begin.

Follow the instructions in the vehicle's infotainment display. Select the option to supervise the manoeuvre remotely. When prompted, check all your belongings and exit the vehicle. Press and hold the authorisation button on the myCadillac app to allow the manoeuvre to complete. As the vehicle automatically steers, brakes, accelerates, and shifts gears into the parking space, stay in close proximity of the vehicle, and check surroundings. Be prepared to

release the authorisation button, or cancel the manoeuvre, to avoid vehicles, pedestrians, or objects.

Once automatic parking is finished and the vehicle has come to a full stop, a message will be displayed indicating parking is complete.

How to Activate Remote Unparking

To activate the unparking manoeuvre remotely, launch Remote Auto Parking from myCadillac app. A screen will be displayed for unparking options. Similar to automatic parking, follow the displayed instructions, press and hold the authorisation button, check surroundings as the vehicle un parks.

Once automatic unparking is finished and the vehicle has come to a full stop, a message will be displayed indicating unparking is complete. The vehicle is now positioned such that the path to exit the parking space is free of obstructions. Enter the vehicle to start driving away.

How to Cancel Remote Automatic Parking or Automatic Unparking

To cancel automatic parking or automatic unparking at any time, press the cancel button on the myCadillac app. Remote Auto Parking applies the parking brake and shifts into P (Park) to hold the vehicle.

Reverse Automatic Braking (RAB)

Reversing Warning and Reverse Automatic Braking (RAB)

Vehicles with Adaptive Cruise Control (ACC) have the Reversing Warning System and Reverse Automatic Braking (RAB) system. When in R (Reverse), Reversing Warning alerts of rear objects at vehicle speeds greater than 8 km/h (5 mph), and RAB may automatically brake hard at speeds between 1–32 km/h (0.5–20 mph).

The Reversing Warning System will beep once from the rear when an object is first detected, or pulse twice on both sides of the Safety Alert Seat. When the system detects a potential crash, beeps will be heard from the rear, or five pulses will be felt on both sides of the Safety Alert Seat. There may also be a brief, sharp application of the brakes.

 **Warning**

The Reversing Warning System only operates at speeds greater than 8 km/h (5 mph). It does not detect children, pedestrians, bicyclists, animals, or objects below the bumper or that are too close or too far from the vehicle. In some situations, such as at higher reversing speeds, there may not be enough time for the short, sharp application of the vehicle brake system to occur. To prevent injury, death, or vehicle damage, even with the Reversing Warning System, always check the area around the vehicle and check all mirrors before reversing.

When the vehicle is in R (Reverse), if the system detects the vehicle is reversing too fast to avoid a crash with a detected object behind your vehicle in your path, it may automatically brake hard to a stop to help avoid or reduce the harm caused by a reversing crash.

 **Warning**

RAB may not avoid many types of reversing crashes. Do not wait for the automatic braking to apply. This system is not designed to replace driver braking and only works in R (Reverse) when an object is detected directly behind the vehicle. It may not brake or stop in time to avoid a crash. It will not brake for objects when the vehicle is moving at very low speeds. It does not detect children, pedestrians, bicyclists, animals, or objects below the bumper or that are too close or too far from the vehicle. To prevent injury, death, or vehicle damage, even with RAB, always check the area around the vehicle before and while reversing.

Pressing the brake pedal after the vehicle comes to a stop will release RAB. If the brake pedal is not pressed soon after the stop, the Electric Parking Brake (EPB) may be set. When it is safe, press the accelerator pedal firmly at any time to override RAB.

 **Warning**

There may be instances where unexpected or undesired automatic braking occurs. If this happens, either press the brake pedal or firmly press the accelerator pedal to release the brakes from the RAB system. Before releasing the brakes, check the RVC and check the area around the vehicle to make sure it is safe to proceed.

Unexpected braking events are possible with a static installed accessory, such as a bike rack or hitch-mounted cargo carrier.

Rear Pedestrian Alert

If equipped, and under certain conditions, this feature can provide alerts for a pedestrian within the system's range directly behind the vehicle. This feature only works in R (Reverse) below 12 km/h (8 mph), and detects pedestrians up to 8 m (26 ft) away during daytime driving. During nighttime driving, feature performance is very limited.



Rear Pedestrian Alert Indicator

When a pedestrian is detected within the system's range directly behind the vehicle, this symbol flashes amber on the infotainment display, along with five beeps from the rear, or if equipped, two pulses from both sides of the driver seat. When a pedestrian is detected close to the vehicle, the symbol flashes red on the infotainment display, along with ten beeps from the rear, or if equipped, seven pulses from both sides of the driver seat.

Warning

Rear Pedestrian Alert does not automatically brake the vehicle. It also does not provide an alert unless it detects a pedestrian, and it may not detect all pedestrians if:

(Continued)

Warning (Continued)

- The pedestrian is not directly behind the vehicle, fully visible to the Rear Vision Camera (RVC), or standing upright.
- The pedestrian is part of a group.
- The pedestrian is a child.
- Visibility is poor, including nighttime conditions, fog, rain, or snow.
- The RVC is blocked by dirt, snow, or ice.
- The RVC, tail lights, or reversing lamps are not cleaned or in proper working condition.
- The vehicle is not in R (Reverse).

To help avoid death or injury, always check for pedestrians around the vehicle before reversing. Be ready to take action and apply the brakes. See *Defensive Driving* ⇨ 151. Keep the RVC, tail lights, and reversing lamps clean and in good repair.

Rear Pedestrian Alert can be set to Off or Alert. To view available settings from the infotainment home screen, touch Settings > Vehicle > Collision/Detection Systems.

If equipped, alerts can be set to beeps or seat pulses. To view available settings from the infotainment home screen, touch Settings > Vehicle > Collision/Detection Systems.

Rear Cross Traffic Alert (RCTA) System

If equipped, Rear Cross Traffic Alert (RCTA) displays a red warning triangle with an arrow pointing left or right on the infotainment display to warn of traffic coming from the left or right. This system detects objects coming from up to 20 m (65 ft) from the left or right-hand side of the vehicle. When an object is detected, either three beeps sound from the left or right, or three Safety Alert Seat pulses occur on the left or right-hand side, depending on the direction of the detected vehicle.

Use caution while reversing when towing a trailer, as the RCTA detection zones that extend out from the back of the vehicle do not move farther back when a trailer is attached to the vehicle.

Rear Cross Traffic Braking (RCTB)

If equipped, RCTB displays a red warning triangle with a left or right pointing arrow on the infotainment screen to warn of traffic coming from the left or right. The system detects objects coming from up to 20 m (65 ft) from the left or right side of the vehicle. When an object is detected, three beeps sounds from the left or right, depending on the direction of the detected vehicle. RCTB will bring the vehicle to a full stop if a collision is imminent.

Driving With a Trailer

Use caution while reversing when towing a trailer. RCTA and RCTB are automatically disabled when a trailer is attached to the vehicle.

Turning the Features On or Off

The  button on the centre console is used to turn on or off the Front and Rear Park Assist, and Reversing Warning and Reverse Automatic Braking (RAB) systems at the same time. The indicator light next to the button comes on when the features are on and turns off when the features have been disabled.

RCTA can be turned on or off using the infotainment system. To view available settings from the infotainment screen, touch Settings > Vehicle > Collision/Detection Systems.

Assistance Systems for Driving

If equipped, when driving the vehicle in a forward gear, Forward Collision Alert (FCA), Lane Departure Warning (LDW), Lane Keep Assist (LKA), Blind Zone Steering Assist (BZSA), Lane Change Alert (LCA), Side Bicyclist Detection, Automatic Emergency Braking (AEB), Intersection Automatic Emergency Braking (I-AEB), and/or the Front Pedestrian Braking (FPB) System can help to avoid a collision or reduce collision damage.

Speed Limiter

If equipped, Speed Limiter allows you to set a maximum speed limit. When Speed Limiter is active at a set speed, it prevents the vehicle from accelerating above the set speed even if you continue to accelerate.

Speed Limiter can be used at speeds of about 20 km/h (12 mph) or more. You can temporarily override the set speed. See "Overriding Speed Limiter" later in this section.

Speed Limiter does not limit the vehicle speed when driving down a hill. If the vehicle speed exceeds the set speed when driving down a hill, beeps will sound to alert you that the vehicle has exceeded the set speed.

 **Warning**

Speed Limiter does not automatically apply the brakes in emergency braking situations. To avoid possible injury or death, always be prepared to brake in emergencies and pay careful attention to the road ahead while driving.

Speed Limiter will automatically be disabled if:

- Cruise control or Adaptive Cruise Control (ACC) is turned on, if equipped.
- Super Cruise is turned on, if equipped.

Speed Limiter is controlled using the RES+ and SET- thumbwheel and the  button on the steering wheel:

RES+ : Move the thumbwheel up to resume Speed Limiter at the last set speed in memory, to increase the set speed (Manual mode), or to increase the offset (Auto mode).

SET- : Move the thumbwheel down to choose the set speed, to decrease the set speed (Manual mode), or to decrease the offset (Auto mode).

 : Press to disengage Speed Limiter while keeping the last set speed in memory.

Automatic Speed Limiter

Automatic Speed Limiter uses an on-board camera and navigation data to identify speed limit road signs and propose a new set speed based on that data.

In Auto mode, you can adjust the set speed with an offset above or below the identified speed limit using the steering wheel controls. See "Turning Speed Limiter On and Off" later in this section.

Warning

In Auto mode, Speed Limiter may not prompt for set speed changes when encountering conditional speed limit signs, for example time frames or when construction workers are present. To avoid a collision, personal injury, or death, always pay attention to posted signs and follow applicable traffic laws.

Manual Speed Limiter

Speed Limiter can also be used in Manual mode. In Manual mode, all changes to the set speed are controlled by the driver.

Selecting the Speed Limiter Mode

To enable Speed Limiter, select a Speed Limiter mode. From the infotainment home screen touch Controls > See More Controls > Drive & Park > Speed Limiter. The following options are available:

- Off
- Manual
- Auto

When a Speed Limiter mode is selected,  will be lit white in the instrument cluster.

Setting Speed Limiter

Press the thumbwheel down to SET- to activate Speed Limiter and use the current vehicle speed as the set speed. When Speed Limiter is active,  will be lit green in the instrument cluster.

Increasing the Set Speed

While Speed Limiter is active, move the thumbwheel up to RES+ to increase the set speed (Manual mode), or to increase the offset from the area speed limit (Auto mode).

- Briefly move the thumbwheel up to RES+ and release it. For each press, the set speed increases by 1 km/h (1 mph).
- Press and hold the thumbwheel up to RES+ to increase the set speed by 5 km/h (5 mph). Release the thumbwheel when the desired set speed is displayed in the instrument cluster.

When using Speed Limiter in Auto mode, there is a predefined maximum allowed value of offset beyond which the set speed cannot be increased.

Decreasing the Set Speed

While Speed Limiter is active, move the thumbwheel down to SET- to decrease the set speed (Manual mode), or to decrease the offset from the area speed limit (Auto mode).

- Briefly move the thumbwheel down to SET- and release it. For each press, the set speed decreases by 1 km/h (1 mph).

- Press and hold the thumbwheel down to SET- to decrease the set speed by 5 km/h (5 mph). Release the thumbwheel when the desired set speed is displayed in the instrument cluster.

When using Speed Limiter in Auto mode, there is a predefined minimum allowed value of offset beyond which the set speed cannot be decreased.

Accept or Decline Automatic Set Speed Changes (Auto)

When Speed Limiter is in Auto mode, is active, and a new speed limit sign is detected, it will propose a new set speed based on the detected speed limit sign. The proposed new set speed will be displayed as a message in the instrument cluster.

- To accept the new set speed, briefly move the thumbwheel down to SET- and release it.
- To decline the new set speed, briefly move the thumbwheel up to RES+ and release it.

If you do not accept or decline the new proposed set speed, there is no change to the set speed.

Conditions Affecting Automatic Speed Limiter (Auto)

- There are changes in brightness, such as entering and exiting tunnels, bridges, and overpasses.
- There are low sun angles.
- Ambient lighting is poor in the evening or early morning.
- There are multiple changes in brightness or there are shadows along the roadway.
- There are conditions associated with low visibility such as mist, rain, snow, or road spray.
- The on-board camera's view of the road is blocked by leaves, snow, or other debris.

If Automatic Speed Limiter becomes temporarily unavailable, change to Manual mode.

Resuming Speed Limiter

If Speed Limiter was active but then  was pressed, Speed Limiter can be resumed using the previous set speed. Briefly move the thumbwheel up to RES+ and release it to activate Speed Limiter using the previous set speed.

If Speed Limiter was turned off because cruise control, ACC, or Super Cruise was turned on, to use Speed Limiter again:

1. Turn off cruise control, ACC, or Super Cruise.
2. On the infotainment home screen, touch Controls > See More Controls > Drive & Park > Speed Limiter.
3. Select Manual or Auto.

Overriding Speed Limiter

When Speed Limiter is active, the set speed can be temporarily overridden only when you fully apply the accelerator pedal. You can control vehicle acceleration again when the vehicle speed is below the set speed.

Turning Off Speed Limiter

To turn off Speed Limiter, from the infotainment home screen, touch Controls > See More Controls > Drive & Park > Speed Limiter > Off.

Forward Collision Alert (FCA) System

The FCA system may help to avoid or reduce the harm caused by front-end crashes. When approaching a vehicle ahead too quickly, FCA provides a red flashing alert

on the windscreen and rapidly beeps or pulses the driver seat. FCA also lights an amber visual alert if following another vehicle much too closely.

FCA detects vehicles within a distance of approximately 110 m (360 ft) and operates at all speeds.

Warning

FCA is a warning system and does not apply the brakes. When approaching a slower-moving or stopped vehicle ahead too rapidly, or when following a vehicle too closely, FCA may not provide a warning with enough time to help avoid a crash. It also may not provide any warning at all. FCA does not warn of pedestrians, animals, signs, crash barriers, bridges, construction barrels, or other objects. Be ready to take action and apply the brakes. See *Defensive Driving* ⇨ 151.

FCA can be disabled through vehicle settings. To view available settings from the infotainment home screen, touch Settings > Vehicle > Collision/Detection Systems.

Detecting the Vehicle Ahead



FCA warnings will not occur unless the FCA system detects a vehicle ahead. When a vehicle is detected, the vehicle ahead indicator will display green. Vehicles may not be detected on bends, motorway exit ramps, or hills, due to poor visibility; or if a vehicle ahead is partially blocked by pedestrians or other objects. FCA will not detect another vehicle ahead until it is completely in the driving lane.

Warning

FCA does not provide a warning to help avoid a crash, unless it detects a vehicle. FCA may not detect a vehicle ahead if the FCA sensor is blocked by dirt, snow, or ice, or if the windscreen is damaged. It may also not detect a vehicle on winding or hilly roads, or in conditions that can limit visibility such as fog, rain,
(Continued)

Warning (Continued)

or snow, or if the headlamps or windscreen are not cleaned or in proper condition. Keep the windscreen, headlamps, and FCA sensors clean and in good repair.

Collision Alert

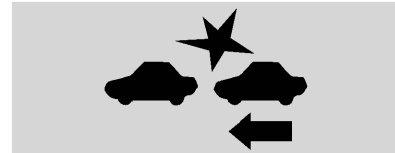

With Head-Up Display

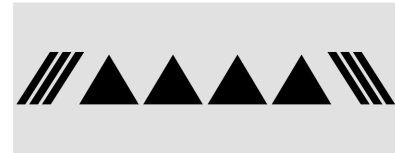

Without Head-Up Display

When your vehicle approaches another detected vehicle too rapidly, the red FCA display will flash on the windscreen. Also, eight rapid high-pitched beeps will sound

from the front, or both sides of the Safety Alert Seat will pulse five times. When this collision alert occurs, the brake system may prepare for driver braking to occur more rapidly which can cause a brief, mild deceleration. Continue to apply the brake pedal as needed.

Tailgating Alert



The vehicle ahead indicator will display amber when you are following a vehicle ahead much too closely.

Selecting the Alert Timing



The Collision Alert control is on the steering wheel. Press  to set the FCA timing to Far, Medium, or Near. The first button press

shows the current setting on the DIC. Additional button presses will change this setting. The chosen setting will remain until it is changed and will affect the timing of both the Collision Alert and the Tailgating Alert features. The timing of both alerts will vary based on vehicle speed. The faster the vehicle speed, the farther away the alert will occur. Consider traffic and weather conditions when selecting the alert timing. The range of selectable alert timings may not be appropriate for all drivers and driving conditions.

If your vehicle is equipped with Adaptive Cruise Control (ACC), changing the FCA timing setting automatically changes the following gap setting (Far, Medium, or Near).

Unnecessary Alerts

FCA may provide unnecessary alerts for turning vehicles, vehicles in other lanes, objects that are not vehicles, or shadows. These alerts are normal operation and the vehicle does not need service.

Cleaning the System

If the FCA system does not seem to operate properly, this may correct the issue:

- Clean the outside of the windshield in front of the rearview mirror.
- Clean the entire front of the vehicle.
- Clean the headlights.

Automatic Emergency Braking (AEB)

The AEB system may help avoid or reduce the damage caused by front-end collisions. AEB also includes Intelligent Brake Assist (IBA). When the system detects a vehicle ahead in your path that is travelling in the same direction that you may be about to crash into, it can provide a boost to braking or automatically brake the vehicle. This can help avoid or lessen the severity of crashes when driving in a forward gear. Depending on the situation, the vehicle may automatically brake moderately or hard. Always wear a seat belt and ensure that all passengers are properly restrained. This automatic emergency braking can only occur if a vehicle is detected. This is shown by the FCA vehicle ahead indicator being lit. See *Forward Collision Alert (FCA) System* ⇨ 196.

The system works when driving in a forward gear above 4 km/h (2 mph). It can detect vehicles up to approximately 60 m (197 ft).

⚠ Warning

AEB is an emergency crash preparation feature and is not designed to avoid collisions. Do not rely on AEB to brake the vehicle. AEB will not brake outside of its operating speed range and only responds to detected vehicles.

AEB may not:

- Detect a vehicle ahead on winding or hilly roads.
- Detect all vehicles, especially vehicles with a trailer, tractors, muddy vehicles, etc.
- Detect a vehicle when weather limits visibility, such as in fog, rain, or snow.
- Detect a vehicle ahead if it is partially blocked by pedestrians or other objects.

Complete attention is always required while driving, and you should be ready to take action and apply the brakes and/or steer the vehicle to avoid crashes.

AEB may slow the vehicle to a complete stop to try to avoid a potential collision. If this happens, AEB may engage the Electric

Parking Brake (EPB) to hold the vehicle at a stop. Release the EPB or firmly press the accelerator pedal.

⚠ Warning

AEB may automatically brake the vehicle suddenly in situations where it is unexpected and undesired. It could respond to a turning vehicle ahead, guardrails, signs, and other non-moving objects. To override AEB, firmly depress the accelerator pedal, if it is safe to do so.

Intelligent Brake Assist (IBA)

IBA may activate when the brake pedal is applied quickly by providing a boost to braking based on the speed of approach and distance to a vehicle ahead.

Minor brake pedal pulsations or pedal movement during this time is normal and the brake pedal should continue to be applied as needed. IBA will automatically disengage only when the brake pedal is released.

⚠ Warning

IBA may increase vehicle braking in situations when it may not be necessary. You could block the flow of traffic. If this occurs, take your foot off the brake pedal and then apply the brakes as needed.

AEB and IBA can be disabled through vehicle settings. To view available settings from the infotainment home screen, touch Settings > Vehicle > Collision/Detection Systems.

⚠ Warning

Using AEB or IBA while towing a trailer could cause you to lose control of the vehicle and cause a collision. Turn the system to Alert or Off when towing a trailer.

A system unavailable message may display if:

- The front of the vehicle or windshield is not clean.
- Heavy rain or snow is interfering with object detection.
- There is a problem with the StabiliTrak system.

The AEB system does not need service.

Intersection Automatic Emergency Braking (I-AEB) System

If equipped, the I-AEB system may help avoid or reduce the harm caused by front-end collisions with crossing vehicles.

The system works when driving in a forward gear above 15 km/h (9 mph) and less than 80 km/h (50 mph). It can detect oncoming vehicles up to approximately 60 m (197 ft).

Warning

I-AEB is an emergency collision preparation feature. Do not rely on I-AEB to brake or avoid collisions. I-AEB will not brake outside of its operating speed range and only responds to detected intersecting vehicles. I-AEB may not:

- detect a crossing or oncoming vehicle on winding or hilly roads.
- detect all vehicles, especially vehicles with a trailer, tractors, muddy vehicles, etc.
- detect a vehicle when weather limits visibility, such as in mist, rain, or snow.

(Continued)

Warning (Continued)

- detect a vehicle ahead if it is partially blocked by pedestrians or other objects.

Complete attention is always required while driving, and you should be ready to take action and apply the brakes and/or steer the vehicle to avoid collisions.

Vehicle Crossing the Path Ahead

When there is a crossing vehicle detected approaching from the right or the left side that may lead to a collision, I-AEB provides a red flashing alert on the windscreen and rapidly beeps or pulses the Safety Alert Seat. See *Advanced Driver Assistance Systems* ⇨ 182. I-AEB can provide a boost to braking or automatically brake the vehicle.

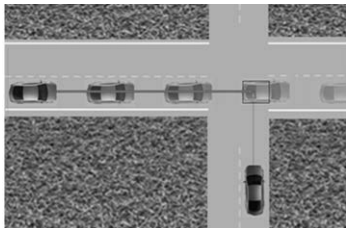

I-AEB can be set to Off, Alert, or Alert and Brake. To view available settings from the infotainment screen, touch Settings > Vehicle > Collision/Detection Systems.

Crossing Traffic Alert

When your vehicle approaches an intersecting vehicle too rapidly and there is risk of a collision, a red warning graphic will flash on the windscreen. Also, eight rapid high-pitched beeps will sound, or the driver seat will pulse five times. The side of the seat that is pulsed and the location of the beeps will depend on the direction that the intersecting vehicle is detected from. When this collision alert occurs, the brake system may prepare for driver braking to occur more rapidly which can cause a brief, mild deceleration. Continue to apply the brake pedal as needed.



With Head-Up Display

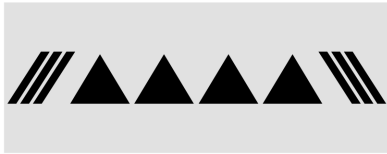

Without Head-Up Display

Turning Across Oncoming Traffic Alert

When your vehicle approaches another detected vehicle too rapidly, a red graphic will flash on the windscreen. Also, eight rapid high-pitched beeps will sound from the front, or both sides of the Safety Alert Seat will pulse five times. When this Collision Alert occurs, the brake system may prepare for driver braking to occur more rapidly which can cause a brief, mild deceleration. Continue to apply the brake pedal as needed.



With Head-Up Display

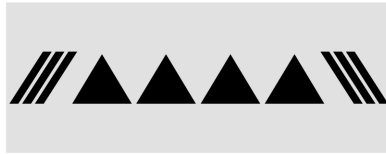

Without Head-Up Display

Automatic Braking

If I-AEB detects it is about to collide into an intersecting vehicle, and the brakes have not been applied, I-AEB may automatically brake moderately or hard. This can help to avoid some collisions or lessen impact by reducing the speed of the vehicle. Always wear a seat belt and check that all passengers are properly restrained. I-AEB can automatically brake between 15 km/h (9 mph) and 80 km/h (50 mph). Automatic braking levels may be reduced under certain conditions, such as higher speeds.

I-AEB may slow the vehicle to a complete stop to try to avoid a potential collision. If this happens, I-AEB may engage the Electric Parking Brake (EPB) to hold the vehicle at a stop. Release the EPB or firmly press the accelerator pedal to continue driving.

I-AEB may also apply the brakes automatically when there is an intersecting vehicle at risk of collision and the system determines that the driver is not braking with sufficient force.

Minor brake pedal pulsations or pedal movement during this time is normal and the brake pedal should continue to be applied as needed.

Warning

I-AEB may automatically brake or increase vehicle braking in situations when it may not be necessary or desired. Your vehicle could block the flow of traffic. I-AEB may respond to stationary or parked vehicles, signs, and other non-moving objects. To override AEB, firmly press the accelerator pedal, if it is safe to do so.

Warning

Using I-AEB while towing a trailer could cause you to lose control of the vehicle and crash. Turn the system to Alert or Off when towing a trailer.

Cleaning the System

If I-AEB does not seem to operate properly, cleaning the outside of the windscreen in front of the rear-view mirror may correct the issue.

Front Pedestrian Braking (FPB) System

If equipped, the FPB system may help avoid or reduce the harm caused by front-end collisions with pedestrians and bicyclists near the forward path of the vehicle when driving in a forward gear. FPB displays an amber indicator, , when a nearby pedestrian or bicyclist is detected ahead. When approaching a detected pedestrian too quickly, FPB provides a red flashing alert on the windscreen and rapidly beeps or pulses the driver seat. FPB can provide a boost to braking or automatically brake the vehicle. This system includes Intelligent Brake Assist (IBA), and the Automatic Emergency Braking (AEB) system may also respond to pedestrians or bicyclists. See *Automatic Emergency Braking (AEB)* ⇨ 198. Always wear a seat belt and ensure that all passengers are properly restrained.

The FPB system can detect and alert to pedestrians or bicyclists in a forward gear at speeds between 8 km/h (5 mph) and 80 km/h (50 mph). During daytime driving, the system detects pedestrians or bicyclists up to a distance of approximately 40 m (131 ft). During night-time driving, system performance is very limited.

Warning

FPB does not provide an alert or automatically brake the vehicle, unless it detects a pedestrian or cyclist. FPB may not detect pedestrians, including children, or cyclists:

- When the pedestrian or cyclist is not directly ahead, fully visible, or standing upright, or when part of a group.
- Due to poor visibility, including night-time conditions, mist, rain, or snow.
- If the FPB sensor is blocked by dirt, snow, or ice.
- If the headlights or windscreen are not cleaned or in proper condition.

(Continued)

Warning (Continued)

Be ready to take action and apply the brakes. For more information, see *Defensive Driving* ⇨ 151. Keep the windscreen, headlights, and FPB sensor clean and in good repair.

FPB can be set to Off, Alert, or Alert and Brake through vehicle settings. To view available settings from the infotainment screen, touch Settings > Vehicle > Collision/Detection Systems.

Detecting the Pedestrian Ahead



FPB alerts and automatic braking will not occur unless the FPB system detects a pedestrian or cyclist. When a pedestrian or bicyclist that may enter the forward path of the vehicle is detected, the pedestrian ahead indicator will display amber.

Front Pedestrian Alert



With Head-Up Display

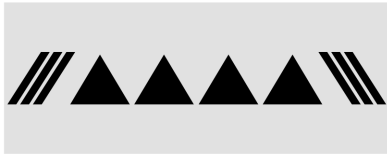

Without Head-Up Display

When the vehicle approaches a pedestrian or cyclist ahead too rapidly, the red FPB alert display will flash on the windscreen. Eight rapid high-pitched beeps will sound from the front, or both sides of the Safety Alert Seat will pulse five times. When this Pedestrian Alert occurs, the brake system may prepare for driver braking to occur more rapidly which can cause a brief, mild deceleration. Continue to apply the brake pedal as needed. Cruise control may be disengaged when the Front Pedestrian Alert occurs.

Automatic Braking

If FPB detects it is about to crash into a pedestrian or cyclist directly ahead, and the brakes have not been applied, FPB may automatically brake moderately or brake hard. This can help to avoid some very low speed pedestrian or bicyclist collisions or reduce pedestrian injury. FPB can automatically brake to detected pedestrians or bicyclist between 8 km/h (5 mph) and 80 km/h (50 mph). Automatic braking levels may be reduced under certain conditions, such as higher speeds.

FPB may slow the vehicle to a complete stop to try to avoid a potential collision with a pedestrian or bicyclist. If this happens, Automatic Braking may engage the Electric Parking Brake (EPB) to hold the vehicle at a stop. Release the EPB. A firm press of the accelerator pedal will also release Automatic Braking and the EPB.

Warning

FPB may alert or automatically brake the vehicle suddenly in situations where it is unexpected and undesired. It could falsely alert or brake for objects similar in shape
(Continued)

Warning (Continued)

or size to pedestrians or cyclists, including shadows. This is normal operation and the vehicle does not need service. To override Automatic Braking, firmly press the accelerator pedal, if it is safe to do so.

Automatic Braking can be disabled through vehicle settings. To view available settings from the infotainment screen, touch Settings > Vehicle > Collision/Detection Systems.

Warning

Using the Front Pedestrian Braking system while towing a trailer could cause you to lose control of the vehicle and crash. Turn the system to Alert or Off when towing a trailer.

Cleaning the System

If FPB does not seem to operate properly, cleaning the outside of the windscreen in front of the rear-view mirror may correct the issue.

Side Blind Zone Alert (SBZA)

If equipped, the SBZA system is a lane-changing aid that assists drivers with avoiding crashes that occur with moving vehicles in the side blind zone (or spot) areas. When the vehicle is in a forward gear, the left or right side mirror display will light up if a moving vehicle is detected in that blind zone. If the indicator is activated and a vehicle is also detected on the same side, the display will flash as an extra warning not to change lanes. Since this system is part of the Lane Change Alert (LCA) system, read the entire LCA section before using this feature.

Lane Change Alert (LCA)

If equipped, the LCA system is a lane-changing aid that assists drivers with avoiding lane change crashes that occur with moving vehicles in the side blind zone (or spot) areas or with vehicles rapidly approaching these areas from behind. The LCA warning display will light up in the corresponding outside mirror and will flash if the indicator is on.

Side Blind Zone Alert (SBZA) is included as part of the LCA system.

Warning

LCA does not alert the driver to vehicles outside of the system detection zones, pedestrians, bicyclists, or animals. It may not provide alerts when changing lanes under all driving conditions. Failure to use proper care when changing lanes may result in injury, death, or vehicle damage. Before making a lane change, always check mirrors, glance over your shoulder, and use the indicators.

LCA Detection Zones

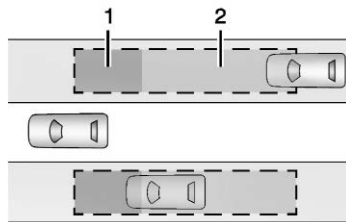

1. SBZA Detection Zone
2. LCA Detection Zone

The LCA sensor covers a zone of approximately one lane over from both sides of the vehicle, or 3.5 m (11 ft). The

height of the zone is approximately between 0.5 m (1.5 ft) and 2 m (6 ft) off the ground. The Side Blind Zone Alert (SBZA) warning area starts at approximately the middle of the vehicle and goes back 5 m (16 ft). Drivers are also warned of vehicles rapidly approaching from up to 70 m (230 ft) behind the vehicle.

How the System Works

The LCA symbol lights up in the side mirrors when the system detects a moving vehicle in the next lane over that is in the side blind zone or rapidly approaching that zone from behind. A lit LCA symbol indicates it may be unsafe to change lanes. Before making a lane change, check the LCA display, check mirrors, glance over your shoulder, and use the indicators.



Left Side Mirror
Display



Right Side Mirror
Display

When the vehicle is started, both outside mirror LCA displays will briefly come on to indicate the system is operating. When the vehicle is in a forward gear, the left or right side mirror display will light up if a moving vehicle is detected in the next lane over in that blind zone or rapidly approaching that zone. If the indicator is activated in the same direction as a detected vehicle, this display will flash as an extra warning not to change lanes.

LCA can be disabled through vehicle personalisation. To view available settings from the infotainment screen, touch Settings > Vehicle > Collision/Detection Systems. If LCA is disabled by the driver, the LCA mirror displays will not light up.

When the System Does Not Seem to Work Properly

The LCA system requires some driving for the system to calibrate to maximum performance. This calibration may occur more quickly if the vehicle is driven on a straight motorway with traffic and roadside objects (e.g., guardrails, barriers). During a trip, the LCA system is not operational until the vehicle first reaches a speed of 24 km/h (15 mph).

LCA displays may not come on when overtaking a vehicle quickly or for a stopped vehicle. LCA may alert to objects attached to the vehicle, such as a bicycle, or object extending out to either side of the vehicle. Attached objects may also interfere with the detection of vehicles. This is normal system operation; the vehicle does not need service.

LCA may not always alert the driver to vehicles in the next lane over, especially in wet conditions or when driving on sharp curves. The system does not need to be serviced. The system may light up due to guardrails, signs, trees, shrubs, and other non-moving objects. This is normal system operation; the vehicle does not need service.

LCA may not operate when the LCA sensors in the left or right corners of the rear bumper are covered with mud, dirt, snow, ice, or slush, or in heavy rainstorms. For cleaning instructions, see “Washing the Vehicle” under *Exterior Care* ⇨ 280. If the DIC still displays the system unavailable message after cleaning both sides of the vehicle toward the rear corners of the vehicle, see your Cadillac Service Centre.

If the LCA displays do not light up when moving vehicles are in the side blind zone or rapidly approaching this zone and the

system is clean, the system may need service. Take the vehicle to your Cadillac Service Centre.

Driving with a Trailer

If equipped with Lane Change Alert (LCA), the LCA detection zones that extend back from the side of the vehicle do not move further back when a trailer is towed.

Use caution while changing lanes when towing a trailer.

Side Bicycle Detection

If equipped, the system may detect a bicyclist approaching from the side or rear of the vehicle.

If this occurs, a chime will sound in the direction of the detection, and the Safety Alert Seat will pulse if enabled through vehicle settings. To view available settings from the infotainment screen, touch Settings > Vehicle > Collision/Detection Systems.

Bicyclist Detection is available when the vehicle is in D (Drive), P (Park), and for a short time after the vehicle is turned off.

If the vehicle detects a bicyclist when it is off, a DIC message may display and alert to the direction of the detection. In some

cases, an Unavailable message may display. This is normal and does not mean that the system is broken.

Detection Zones

When the vehicle is in P (Park) or is turned off, a bicyclist can be detected 11 m (36 ft) behind the vehicle or 10 m (33 ft) to the side of the vehicle.

When the vehicle is in D (Drive), a bicyclist can be detected 3 m (10 ft) behind the vehicle or to the side of the vehicle.

Turning the Feature On or Off



Bicyclist Detection can be turned on or off through vehicle settings. To view available settings from the infotainment screen, touch Settings > Vehicle > Collision/Detection Systems.

Blind Zone Steering Assist (BZSA)

If equipped, the Blind Zone Steering Assist (BZSA) system can detect a potential collision with a moving vehicle in the lane you are entering. It provides a brief, urgent turn of the steering wheel to alert you to take action to avoid a collision.

BZSA works with the Lane Keep Assist (LKA). BZSA operates when the vehicle is in a forward gear, and only when LKA is enabled and able to assist. See *Lane Keep Assist (LKA)* ⇨ 210.

BZSA will provide a steering correction when your vehicle is about to leave the current lane of travel, with the possibility of a collision with a vehicle in the adjacent lane. This steering correction happens closer to the centre of the lane and has a stronger steering correction than LKA. Unlike LKA, the steering correction with BZSA will happen even if your indicator is on in the direction of lane departure.

In addition to the BZSA steering intervention, the  will turn amber, six beeps or six seat pulses will occur, if equipped with Safety Alert Seat, and  or  will flash on the outside rear-view mirror.

Warning

Do not rely on Blind Zone Steering Assist (BZSA) to prevent collisions. This system does not replace the need to pay

(Continued)

Warning (Continued)

attention and drive safely. Failure to use proper care when driving may result in vehicle damage, injury, or death.

- BZSA performance may be affected by weather and road conditions.
- BZSA does not provide steering assistance to avoid a vehicle that is in, or has entered, your lane of travel.
- BZSA will not prevent a towed trailer from crossing into the adjacent lane. Always monitor the trailer position while towing to ensure it is in the same lane as your vehicle. BZSA is only designed to detect when your vehicle unintentionally crosses detected lane lines.

Traffic Sign Assistant

If equipped, Traffic Sign Assistant recognises designated traffic signs via the front camera located behind the windscreen in front of the interior rear view mirror, and displays the detected speed limit in the Driver Information Centre (DIC). Additionally, speed limit information from the navigation system map database may be used.

Caution

The system is intended to assist the driver within a defined speed range to discern certain traffic signs. Always pay attention to posted speed limit signs.

Do not ignore traffic signs which are not displayed by the system.

The system does not discern any signs other than the conventional traffic signs that might give or end a speed limit. It may not detect some electronic speed signs.

Depending on the weather conditions or problems with traffic signs, a traffic sign may not be recognised or a sign different from the actual traffic sign may be displayed.

Do not let this special feature tempt you into taking risks when driving.

Always adapt vehicle speed to the road conditions.

Driver assistance systems do not relieve the driver from full responsibility for vehicle operation.

Traffic signs that are detected are:

- Speed Limit
- Constraint Signs

Display Indication

The currently detected speed limit is displayed in the DIC until the next speed limit or end of speed limit sign is detected. Depending on the vehicle, the current valid speed limit is permanently displayed on the DIC or in the upper left of the instrument cluster.

A (–) symbol in a frame indicates there is a sign detected which cannot be clearly identified by the system.

A (/) symbol in a frame indicates that the feature is turned off or has failed.

See *Driver Information Centre (DIC)* ⇨ 105.

Alert Function

If equipped, a chime may sound when you have exceeded the indicated speed limit, or if a new speed limit is detected.

The alert function can be turned on or off. To view available settings from the infotainment screen, touch Settings > Vehicle > Collision/Detection Systems.

Each time the vehicle is started, the customisation options will be turned on.

Exceeding Indicated Speed Limit

If the indicated traffic sign speed limit is exceeded by 5 km/h (3 mph) or more, the permanently displayed traffic sign symbol will flash until the vehicle speed is reduced to or below the indicated speed limit.

System Reset

The content of the traffic sign display can be cleared. To view available settings from the infotainment screen, touch Settings > Vehicle > Collision/Detection Systems.

Upon successful reset, a (–) symbol displays until the next traffic sign is detected or provided by the navigation system map data. In some cases, traffic sign memory is cleared automatically by the system.

Alert function will automatically be turned on when the system is reset.

See *Driver Information Centre (DIC)* ⇨ 105.

Navigation System Traffic Sign Detection

The currently displayed sign can either originate from sign detection using the camera, or from the navigation system map data. If the currently displayed sign

originates from map data and the map information changes, a new sign will be displayed. This may lead to detection of a new sign, although no sign on the road may have been passed. If the map data is unavailable, Traffic Sign Assistant will turn off automatically.

Traffic Sign Map Data Update

In order for the system to keep operating correctly, the traffic sign map data must be updated on at least an annual basis. Periodic updates will be made available to you at no cost for 14 years from the manufacturing date of the vehicle.

Your vehicle will remind you to update the traffic sign map data once a year. Check for new updates at www.gmnavdisc.navigation.com/speedsignmap.

To update:

1. Download the map updates to a USB-C flash drive.
2. Insert USB-C flash drive into the vehicle's USB port. See *USB Port* ⇨ 130.

3. From the infotainment home screen, touch Settings > Display > Instrument Cluster > Traffic Sign Recognition > Traffic Sign Data and follow the prompts on screen.

Do not plug anything else into the USB ports while the transfer is in progress. A message will appear on the infotainment screen when the transfer is complete.

Limitations

Traffic sign memory may not operate correctly if:

- The area of the windshield, where the front camera is located, is not clean or is affected by foreign objects, e.g. stickers, window tinting, etc.
- Traffic signs are completely or partially covered, are too low or high or difficult to discern.
- Traffic signs are incorrectly mounted or are damaged.
- Traffic signs do not comply with the approved traffic sign standards.
- The speed limit is displayed by certain types of electronic speed signs.

- There are adverse environmental conditions, e.g. heavy rain, snow, direct sunlight or shadows.
- The headlights are dirty or not correctly aligned when driving at night.
- The navigation map data is out of date.
- The navigation map is unavailable.

Driver Attention Assist

If equipped, Driver Attention Assist alerts the driver to pay closer attention to the road ahead. Driver Attention Assist uses a camera-based Driver Monitoring System. The Driver Monitoring System on the steering column continually monitors the driver's head movements and eye gaze location to determine if the driver is drowsy or distracted. Depending on the level of the driver's distraction or drowsiness, Driver Attention Assist will provide visual warnings, chimes, and haptic movements to gently guide the driver to look back at the road.

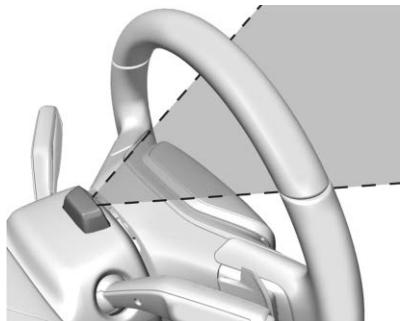

Sunglasses, hats, or other types of clothing that change the shape of the head may interfere with camera performance. To improve camera performance, raise or lower the steering wheel, or change the seat position.

Driver Attention Assist does not record video or audio. It is only active while driving with the feature enabled.

How to Activate Driver Attention Assist

Driver Attention Assist turns on automatically every time the vehicle is started. The feature can be enabled or disabled through vehicle settings. To view

available settings from the infotainment screen, touch Settings > Vehicle > Collision/Detection Systems.

Drowsiness Alerts

Depending on the drowsiness level, Driver Attention Assist will display escalating alerts in the instrument cluster. These alerts progress as the drowsiness level increases. Each level is designated by a coffee cup and a DIC message recommending that the driver consider taking a rest break.

Depending on the driver's drowsiness level, the system will also send chimes or haptic alerts, if equipped with Safety Alert Seat. Not all alerts may occur during a drowsy event.

When the maximum drowsiness alert occurs, the driver will be presented with the following options on the infotainment screen:

- Phone a Friend
- Open a Playlist
- Navigate to Nearest Point of Interest (POI)

Select an option from the list and follow the instructions displayed on infotainment screen.

Attention Alerts

Depending on the attention level, Driver Attention Assist will display escalating alerts in the instrument cluster that advance from level 1 to level 2 as the attention level decreases. Depending on the driver's distraction level, the system will also send chimes or haptic alerts, if equipped with Safety Alert Seat. See *Driver Attention Assist Light* ⇨ 99.

Cleaning the Camera

The camera lens cover on the steering column may become dirty over time. If this occurs, clean the lens cover with a soft cloth sprayed with glass cleaner. Wipe the lens gently, then dry it. Never use abrasive cloths, cleaners, or corrosive chemicals of any kind on the lens cover.

Limitations

Some factors can impact the performance of the Driver Attention Assist feature, causing it to not function as intended. These include (but are not limited to):

- damage to the Driver Monitoring System, camera, or lens.
- the camera being blocked by the steering wheel, hands, or objects.

If there is a problem with the system, a DIC message or icon in the instrument cluster may display.

Lane Keep Assist (LKA)

If equipped, LKA may help avoid crashes due to unintentional lane departures. This system uses a camera to detect lane markings. The LKA system can be ready to assist at speeds between approximately 60 km/h (37 mph) and 180 km/h (112 mph). On some vehicles, the system will instead operate above 50 km/h (31 mph). LKA may assist by gently turning the steering wheel if the vehicle approaches a detected lane marking. It may also provide a Lane Departure Warning (LDW) alert if the vehicle crosses a detected lane marking. This system is not intended to keep the vehicle centred in the lane. LKA will not assist and alert if the indicator is active, or if it detects that you are accelerating, braking or actively steering. LKA can be overridden by turning the steering wheel. If the system detects you are steering intentionally across a lane marker, the LDW will not be given. Do not expect the LDW to occur when you are intentionally crossing a lane marker.

Warning

The LKA system does not continuously steer the vehicle. It may not keep the vehicle in the lane or give a Lane Departure Warning (LDW) alert, even if a lane marking is detected.

The LKA and LDW systems may not:

- Provide an alert or enough steering assist to avoid a lane departure or crash.
- Detect lane markings under poor weather or visibility conditions. This can occur if the windscreen or headlamps are blocked by dirt, snow or ice; if they are not in proper condition; or if the sun shines directly into the camera.
- Detect road edges.
- Detect lanes on winding or hilly roads.

If LKA only detects lane markings on one side of the road, it will only assist or provide an LDW alert when approaching the lane on the side where it has detected a lane marking. Even with LKA and LDW, you must steer the vehicle.

(Continued)

Warning (Continued)

Always keep your attention on the road and maintain proper vehicle position within the lane, or vehicle damage, injury or death could occur. Always keep the windscreen, headlamps and camera sensors clean and in good repair. Do not use LKA in bad weather conditions or on roads with unclear lane markings, such as construction zones.

Warning

Using LKA on slippery roads could cause loss of control of the vehicle and a crash. Turn the system off.

Warning

LKA will not alert the driver if a towed trailer crosses into an adjacent lane of travel. Serious injury or property damage may occur if the trailer moves into another lane. Always monitor the trailer position while towing to make sure it is within the same lane as the towing vehicle.

How the System Works

LKA uses a camera sensor installed on the windscreen ahead of the rearview mirror to detect lane markings. It may provide brief steering assistance if it detects an unintended lane departure. It may further provide an audible alert, or the driver seat may pulse, indicating that a lane marking has been crossed. The system does not provide a Lane Departure Warning (LDW) when intentionally steering across a lane marker.

To turn LKA on and off, press \swarrow \searrow on the centre console. If equipped, the indicator light on the button illuminates when LKA is on and turns off when LKA is disabled. On some vehicles, a long press of over three seconds is required to turn LKA off.

LKA may not be available in extremely cold temperatures of less than approximately -30° f (-34° c).

When activated, \swarrow \searrow is white, if equipped, indicating that the system is not ready to assist. \swarrow \searrow is green if LKA is ready to assist. LKA may assist by gently turning the steering wheel if the vehicle approaches a detected lane marking. \swarrow \searrow is amber when assisting. It may also provide a Lane

Departure Warning (LDW) alert by flashing \swarrow \searrow amber if the vehicle crosses a detected lane marking. Additionally, there may be three beeps, or the driver seat may pulse three times, on the right or left, depending on the lane departure direction.

Take Steering

The LKA system does not continuously steer the vehicle. If LKA does not detect active driver steering, an alert and chime may be provided. Steer the vehicle to dismiss. LKA may become temporarily unavailable after repeated false steering alerts.

When the System Does Not Seem to Work Properly

The system performance may be affected by:

- Close vehicles ahead
- Sudden lighting changes, such as when driving through tunnels
- Banked roads
- Roads with poor lane markings, such as two-lane roads

If the LKA system is not functioning properly when lane markings are clearly visible, cleaning the windscreen may help.

A camera blocked message may display if the camera is blocked. Some driver assistance systems may have reduced performance or not work at all. An LKA or LDW unavailable message may display if the systems are temporarily unavailable. This message could be due to a blocked camera. The LKA system does not need service. Clean the outside of the windscreen behind the rearview mirror.

LKA assistance and/or LDW alerts may occur due to tar marks, shadows, cracks in the road, temporary or construction lane markings, or other road imperfections. This is normal system operation; the vehicle does not need service. Turn LKA off if these conditions continue.

Charging

When to Charge

When the high voltage battery is low, the following charging messages may display on the Driver Information Centre (DIC):

CHARGE VEHICLE SOON : The battery needs to be charged soon.

REDUCED ACCELERATION DRIVE WITH CARE :

The accelerator pedal response is reduced and the remaining range value changes to LOW, charge the vehicle immediately. See *Propulsion Power Messages* ⇨ 111.

OUT OF ENERGY, CHARGE VEHICLE NOW :

The battery charge is fully depleted. The vehicle will slow to a stop. Brake and steering assist will continue operating. Once stopped, turn the vehicle off.

Plug-In Charging

Plug-in charge times vary based on the battery condition, charge level, and the outside temperature. See *Charging* ⇨ 100 for charge mode selection.

Do not allow the vehicle to remain in temperature extremes for long periods without being driven or plugged in. When temperatures are below 0 °C (32 °F) and above 32 °C (90 °F), plug in the vehicle to maximise high voltage battery life.

In extreme temperature conditions, a full charge will take additional time.

Charging will slow down as the battery fills up. Charge the battery to 80% for daily driving, or when driving in mountainous

terrain. The vehicle can be charged above 80% for long trips when not driving in mountainous terrain.

GM recommends the following:

- Unless your drive requires a full charge, charge the high voltage battery to 80% or less.
- Avoid allowing the high voltage battery to fall below 20% charged, if possible. See *Battery* ⇨ 249.
- If your route includes steep mountain terrain or if you are towing a trailer, it is important that your battery charge level is 80% or less to maximise regenerative braking performance.

It is normal to hear fans, pumps, and electrical devices clicking while the vehicle is turned off and charging.

The vehicle does not require indoor charging area ventilation before, during, or after charging.

The vehicle cannot be driven while the charging cable is plugged into the vehicle.

Caution

To avoid damage to the vehicle, make sure the charging cable plug is in good condition, is not worn or damaged, and is connected securely to the vehicle's charging port. If vehicle charging is intermittent, disconnect the cable and inspect for damage. An excessively worn or damaged AC or DC charging cable plug may result in an intermittent connection and potential damage to the vehicle's charging port.

There are several infotainment screens that will display depending on the current charging status. See *Charging* ⇨ 100.

Charging Override

A CHARGING OVERRIDE/INTERRUPTION OCCURRED message may display to indicate that a charging override or interruption has occurred due to one or more of the following events:

- Override of the charge settings by the owner.
- Unintended interruption of AC power at the vehicle's charge port.

- Interruption of charging by the utility company.

AC Charging

If equipped, a loss of AC power alert may sound for a short time if AC power is lost for over one minute. This sound alert can be turned off. See *Charging* ⇨ 100.

To Start AC Charging

1. Put the vehicle in P (Park).



2. Push the top right corner of the charge port door and release to open the door.

In cold weather conditions, ice may form around the charge port door. Remove ice from the area before attempting to open or close the charge port door.

3. Open the tailgate, lift the load floor cover, and remove the charging cable.
4. Plug the charge cord into the electrical outlet. To verify the charging cable status, see *Electrical Requirements for Battery Charging* ⇨ 225 and *Charge Cord* ⇨ 218. For instructions to set cable limit settings for a charge session, see *Charging* ⇨ 100.
5. Plug in the AC charging cable into the vehicle charge port. Make sure the AC vehicle plug is fully connected to the AC charge port. If it is not properly connected, the vehicle may not be charged.
6. Verify that the charge status light turns on and an audible chirp occurs. See *Charging Status Feedback* ⇨ 217.

To End AC Charging

1. Press  on the remote key to unlock the charging cable or by tapping "Stop" on the Charging page on your infotainment screen.

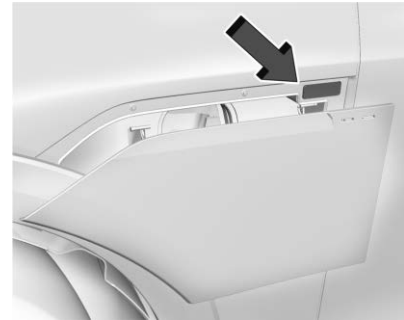

2. Press the button to manually close the charge port door.
3. Unplug the charge cord from the electrical outlet.
4. Place the charge cord into the storage compartment.

DC Charging

DC Charging Station Hardware

The vehicle can be charged using DC charging equipment typically found at service stations and other public locations.

Check the charging station DC vehicle plug for compatibility with the DC charge port on this vehicle. This vehicle is compatible with Combined Charging System 2 (CCS2) connector.

When recharging at a DC charge station, the charging cable connected to the vehicle must be less than 10 m (33 ft) in length to meet functionality and regulatory requirements.

Warning

Do not use the charging station if the handle has defects such as cracks, exposed wires, burnt or missing pins, or any other damage. A damaged handle may result in personal injury and/or damage to the vehicle, the charging port or other property.

For maximum charging performance, and to prevent charging interruptions or damage to the high voltage battery and vehicle:

- Remove your hands from the charging handle once it has been plugged in. If not done, this can cause a charging interruption.
- Ensure that the charging cable plug clicks.

Follow the steps listed on the charging station to perform a DC vehicle charge.

If for any reason DC charging does not begin or is interrupted, check the DC charging station display for messages. Unplug the cable to restart the DC charging process.

To Start DC Charging

1. Put the vehicle in P (Park).



2. Push the rearward edge of the charge port door and release to open the door.
In cold weather conditions, ice may form around the charge port door. The charge port door may not open on the first attempt. Remove ice from the area and repeat attempting to open the charge port door.

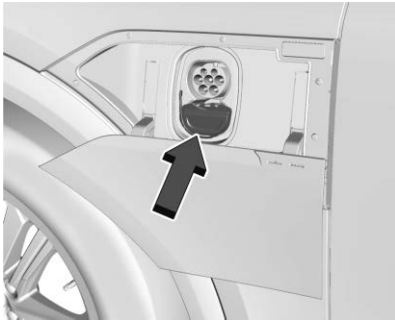

3. Unlatch the DC charging dust cover and lower it fully.
4. Plug in the DC charging cable into the vehicle charge port. Make sure that the DC vehicle plug is fully connected to the DC charge port. If it is not properly connected, the vehicle may not be charged. Check the Driver Information Centre (DIC) to make sure the vehicle plug is connected properly.
5. Follow the steps listed on the charging station to start charging.
6. When charging is active, the DC vehicle plug is locked to the DC charge port and cannot be disconnected.

7. Verify that the charge status light turns on and an audible chirp occurs. See *Charging Status Feedback* ⇨ 217.

Caution

Do not attempt to disconnect the DC vehicle plug while charging is active. This action may damage the vehicle or charging station hardware.

To Stop DC Charging — Automatic

When the vehicle no longer needs power from the charging station, it stops charging and the DC vehicle plug unlocks from the DC charge port.

Energy can still be consumed from the charging station when the vehicle displays and indicators show that the battery is fully charged. This is to ensure the battery is in optimal temperature operating range to maximise vehicle range. See *Charging* ⇨ 100.

To End DC Charging

When the vehicle is fully charged, charging automatically stops and the plug unlocks. You can also manually stop charging using the button on the DC vehicle plug, the

controls at the charging station or by tapping "Stop" on the Charging page on your infotainment screen.

If the vehicle plug does not unlock from the vehicle charge port after a charge, contact your Cadillac Brand Ambassador.

1. Unplug the DC vehicle plug from the DC charge port on the vehicle and close the dust cover.
2. The charge port door will automatically close when the charging cable is unplugged.



3. Press the button to manually close the charge port door.

Emergency Manual Charging cable Release

The charging cable is equipped with an emergency manual charging cable release in the event the cable cannot be released normally during DC charging.

1. Open the bonnet. See *Bonnet* ⇨ 243.



2. Remove the cover to access the emergency manual charging lead release handle.

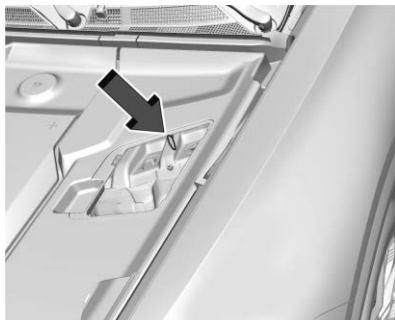

3. Pull the emergency manual charging cable release handle. The DC charging cable will release.

To Stop AC or DC Charging

Controls on the charging station can be used to stop the charge process at any time.

To stop charging when inside the vehicle, use the Stop Charge button on the Charging screen. See “Active Charging” under *Charging* ⇨ 100.

Delayed Charging Override

To temporarily override a delayed charge event, unplug the charge cord from the charge port and then plug it back in within five seconds. A single audible chirp will sound and charging will begin immediately.

To cancel a temporary override, unplug the charge cord, wait for 10 seconds, and then plug the charge cord back in. A double audible chirp will sound and charging will be delayed.

See *Charging* ⇨ 100 for advanced charge scheduling options.

Charging Status Feedback

The vehicle is equipped with a charge status light.



When the charging cable is plugged in, a colour appears to indicate the charging status.

Refer to the table for charging status feedback:

Charge Status Light Colour	Sound	Action/Reason
Solid Blue	-	Initial connection is successful.
Pulsing Blue	Two audible chirps	Charging is delayed by charging screen or by a total utility interruption. Charging will begin later. See <i>Interruption of Charging by the Electricity Supplier</i> ⇨ 225. Utility Override ("Demand Response").
Flashing Green (the longer the flash, the higher the state of charge)	One audible chirp	Vehicle is actively charging.
Solid Green	None	Charging is complete.
Pulsing Red	None	Error Check the charging cable connection. There may be no power supplied to the vehicle.
None (upon plug-in)	None	Check the charging cable connection.

Charge Status Light Colour	Sound	Action/Reason
None (after blue and green lights up)	None	Check the charging cable connection. If the connection is good, this may indicate a power failure or a total utility interruption, and charging will begin later. It may also occur if a high voltage charging system fault is detected. See <i>Interruption of Charging by the Electricity Supplier</i> ⇨ 225 or <i>Service Vehicle Soon Light</i> ⇨ 93.
None	Three audible chirps when the driver door is opened	The charge port door is open.
Flashing Green (the longer the flash, the higher the state of charge)	Four audible chirps	The currently set departure time cannot be met. May be due to charging power level or charge schedule setting factors. Refer to the charging screen for actual charge completion time. See <i>Charging</i> ⇨ 100.

Charge Cord

IMPORTANT SAFETY INSTRUCTIONS



This symbol indicates risk of electrical shock.

The vehicle comes with a portable charging cable used to charge the high voltage battery. When used correctly, the Charging cable provides a safe connection between a standard wall receptacle and your vehicle's on-board charger.

To operate AC charging, the following is needed:

1. 230 Volt Connectors
2. Charging cable Vehicle Plug
3. Charging cable Control Box (charging cable status indicator included)

Important Information about Portable Electric Vehicle Charging

- Charging an electric vehicle can stress a building's electrical system more than a typical household appliance.
- Before plugging the charging cable into any electrical socket, have a qualified electrician inspect and verify the electrical system (electrical socket, wiring, junctions, and protection devices) is suitable for a heavy-duty service.
- Electrical sockets may wear out with normal usage or may be damaged over time, making them unsuitable for electric vehicle charging.
- Check the electrical socket/plug while charging and discontinue use if the electrical socket/plug is hot, then have the electrical socket serviced by a qualified electrician.
- When outdoors, plug into an electrical socket that is weatherproof while in use.
- Do not attempt to use the charging cable with non-utility supplied electrical power sources such as backup generating equipment.
- If the charging cable overheats, remove from direct sunlight.
- Disconnect the charging cable from the vehicle before disconnecting the attachment plug from the wall.
- When charging your vehicle, ensure all components are connected properly, there is no damage, and the socket has power.
- Do not use the charging cable in severe weather conditions.

Danger

Improper use of portable electric vehicle charge cords may cause a fire, electrical shock, or burns, and may result in damage to property, serious injury, or death.

- Do not use extension cables, multi-socket power strips, splitters, earthing adapters, surge protectors, or similar devices.
- Do not use an electrical socket that is worn or damaged, or will not hold the plug firmly in place.
- Do not use an electrical outlet that is not properly grounded.
- Do not use an electrical outlet that is on a circuit with other electrical loads.

Warning

When using electric products, basic precautions should always be followed, including the following:

- Read all the safety warnings and instructions before using this product. Failure to follow the warnings and the instructions may result in electric shock, fire, and/or serious injury.
- Never leave children unattended near the vehicle while the vehicle is charging and never allow children to play with the charging cable.
- If the plug provided does not fit the electrical socket, do not modify the plug. Arrange for a qualified electrician to inspect the electrical socket.
- Do not put fingers into the electric vehicle connector.

⚠ Warning

- To reduce the risk of fire, installations shall comply with the requirements of National Electric Code IEC 60364 – Electrical Installations in Buildings, depending on the region in which the unit is being installed. The installer shall comply with any additional local requirements mandated by the country and/or municipality.
- Do not use this product if the flexible power cable or the electric vehicle cable is frayed, has broken insulation, or shows any other signs of damage.
- Do not use this product if the enclosure or the vehicle plug is broken, cracked, open, or shows any other indication of damage.
- The plug must be plugged into an appropriate electrical socket that is properly installed in accordance with all local codes and ordinances. Do not modify the plug provided with the product. If the plug does not fit the electrical socket, have a proper electrical socket installed by a qualified electrician. If earth is missing,
(Continued)

Warning (Continued)

the charging cable indicators will indicate an electrical system fault and the vehicle may not charge.

Installing and Operating the Portable Charging cable

The charging cable must be on a dedicated individual branch circuit. A dedicated circuit ensures that there is enough power available without overloading the system.

If a dedicated circuit is not used, the circuit breaker could trip or open. If a dedicated circuit is not available, contact a qualified electrician. See “Grounding Instructions” later on in this section.

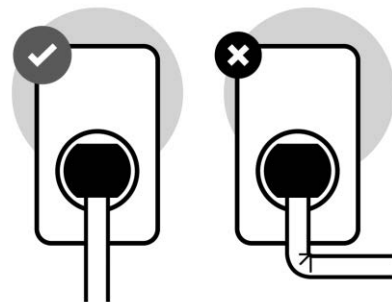

1. Handle electrical cables with care. Do not sharply bend, pull, or crush cables.
2. Snap the desired connectors into the control box before making any other connections.

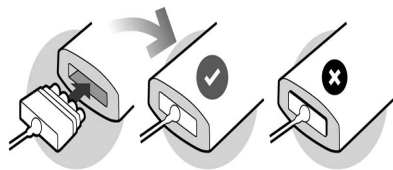

Ensure the connectors are fully inserted into the control box or the charging cable will not work properly.

3. Connect the attachment plug to the electrical socket. Refer to the “Charging Cable Status Indicator” section to ensure the charging cable is working properly.
4. Insert the vehicle plug into the vehicle charge port to initiate charging.
5. To disconnect the charging cable, pull the vehicle plug until it is disconnected. Once disconnected from the vehicle, the charging cable can be unplugged from the wall.

Avoid the following actions:

- Placing the control box and charging cable in a location it may be submerged in water (or other liquid substances) or subject to physical abuse.
- Coiling or storing the charging cable in a location it may be crushed or forced into space to form a circle smaller than 178 mm (7 in).
- Restricting the cable rotation or applying excessive pulling force while wrapping.
- Wrapping the cable around the housing of the control box.

Charging cable Status Indicator

After plugging in the charging cable, it will perform a quick self test.

Verify the charging cable status on the charging cable control box. The charging cable uses a combination of red, blue, and amber indicators to display the status of the charging cable.

222 Driving and Operating

Amber	Blue	Red	Reason	Action
-	-	-	The charging cable has no power.	Verify all components are connected properly, there is no damage, and the socket has power. If the error continues, contact your Cadillac Brand Ambassador.
-	On	-	The charging cable is ready to use.	Plug the charging cable into the vehicle charge port to begin charging.
-	Flashing	-	Vehicle is actively charging.	No action needed.
On	On	On	An error has occurred and the charging cable is rebooting.	Wait for the charging cable to return to a solid blue. If it reboots two or three more times, unplug the charging cable from the vehicle. If the error continues, contact your Cadillac Brand Ambassador.
On	Flashing	-	Due to internal overheating from the charging cable control box, charging is at a reduced rate.	If unplugging and re-plugging in does not work, move the charging cable away from direct sunlight and/or hot surfaces such as asphalt paving.
Flashing	Flashing	-	Due to overheating on the AC plug or electrical socket, charging is at a reduced rate.	Disconnect from the electrical socket. If the error persists, have a qualified electrician inspect and repair the issue.

Amber	Blue	Red	Reason	Action
On	-	-	The charger is troubleshooting after an error and requires a reboot. There are multiple reasons a charging cable may have an error. One of the most common errors is that it may be due to a Missing Utility Ground Fault.	<p>Try the following actions to restore the full charging rate:</p> <ul style="list-style-type: none"> - Verify all components are connected properly. Ensure the connectors are fully inserted into the control box or the charging cable will not work properly. - Unplug and re-plug in the connector. - If the charging cable is in a warm environment, try charging in a cooler area. - Try a different socket or connector, if available. <p>If the error continues, contact your Cadillac Brand Ambassador.</p>
-	-	Flashing	There is a Ground Fault Circuit Interruption (GFCI) fault.	If the error is caused by a Ground Fault Circuit Interruption (GFCI) fault, the charger will shut down and the charging status indicator turns red. Unplug and re-plug the charging cable to reset the charging. Try a different connector, if available. If this error continues, stop charging your vehicle. See your Cadillac Brand Ambassador for service.
-	-	On	There is a cableset internal fault.	Immediately disconnect from the electrical socket and the vehicle. Contact your Cadillac Brand Ambassador for a replacement.

If the charging cable status indicator is not lit, ensure the electrical socket has power.

Charge Level Selection

Charge level selection can be made using the Charging tab in the Energy Application on the infotainment display. For instructions to set cable limit settings for a charge session, see *Charging* ⇨ 100.

Warning

Using a charge level that exceeds the electrical circuit or electrical outlet capacity may start a fire or damage the electrical circuit. Use the lowest charge level until a qualified electrician inspects the electrical circuit capacity. Use the lowest charge level if the electrical circuit or electrical outlet capacity is not known.

Troubleshooting

Disconnect the charging cable from the vehicle and confirm that the attachment plug is not too hot to grasp before removing.

If it is not hot, manually reboot the charging cable by unplugging and re-plugging the attachment plug into the

electrical socket. If the same fault reoccurs, test the charging cable with a different electrical socket.

The charging cable monitors temperature at several locations and may reduce charging power or interrupt charging if temperatures become too high. The charging cable status indicators illuminate and identify this fault. In hot climates, move the charging cable away from direct sunlight and/or hot surfaces such as asphalt paving for approximately 30 minutes.

If there are signs of melting or scorching, do not touch the charging cable or attachment plug. Have a qualified electrician inspect and repair the issue.

If there are no signs of damage, check how firm the fit of the plug is. If the plug easily pulls away from the electrical socket, test the plug on a known good electrical socket. If the fault condition returns, have your charging lead inspected by your Cadillac Brand Ambassador. If the fault does not return, stop using the suspected circuit and have a qualified electrician inspect and repair the issue.

Grounding Instructions

The charge circuit must be earthed. If the charge circuit should malfunction or break down, earthing provides a path of least resistance for the electric current to reduce the risk of electric shock. This product is equipped with a cable that has an equipment earthing conductor and an earthing plug. The plug must be plugged into an appropriate socket that is properly installed and earthed in accordance with all local codes and ordinances.

Warning

Improper connection of the charging cable earth may cause electrical shock. Check with a qualified electrician if there is doubt as to whether the charge circuit is properly earthed. Do not modify the plug provided with the product. If it will not fit the electrical socket, have a proper electrical socket installed by a qualified electrician.

Interruption of Charging by the Electricity Supplier

This vehicle responds to requests through the utility company to limit or completely block electrical power grid use. This feature is inactive during DC charging. A utility interruption will lengthen the vehicle charge time.

When electrical grid power is completely blocked, the vehicle will not charge until the utility interruption has expired. The vehicle should be left plugged in so that the vehicle will automatically resume charging.

Changing the charge mode to Charge Now or performing a delayed charging override will not disable a utility interruption.

A message will display on the instrument cluster indicating that a utility interruption has occurred.

Electrical Requirements for Battery Charging

The vehicle is designed for compatibility with most standard vehicle charging equipment in the region of sale. Check for charger compatibility before purchasing a charger

The portable charging cable requires a circuit capacity as follows:

Minimum : 120 volt system – 15 amps

Maximum : 240 volt system – 50 amps

Caution

Do not use portable or stationary backup generating equipment to charge the vehicle. This may cause damage to the vehicle's charging system. Only charge the vehicle from the mains electricity supply.

Trailer Towing

General Towing Information

Only use towing equipment that has been designed for the vehicle. Contact your Cadillac Service Centre for assistance with preparing the vehicle to tow a trailer. Read the entire section before towing a trailer.

To tow a disabled vehicle, see *Transporting a Disabled Vehicle* ⇨ 278.

Driving Characteristics and Towing Tips

Warning

You can lose control when towing a trailer if the correct equipment is not used or the vehicle is not driven properly. For example, if the trailer is too heavy or the trailer brakes are inadequate for the load, the vehicle may not stop as expected. You and others could be seriously injured. The vehicle may also be damaged, and the repairs would not be covered by the vehicle warranty. Pull a trailer only if all the steps in this section have been followed. Ask your Cadillac Service Centre for advice and information about towing a trailer with the vehicle.

Driving with a Trailer

Trailer driving is different than just driving the vehicle by itself. Trailering affects handling, acceleration, braking, and durability. Successful and safe trailering requires proper use of the correct equipment.

The following information has many time-tested, important trailering tips and safety rules. Many of these are important for your safety and that of your passengers. Read this section carefully before towing a trailer.

When towing a trailer:

- Become familiar with, and follow all state and local laws that apply to trailer towing. These requirements vary from state to state.
- State laws may require the use of extended side view mirrors. If your visibility is limited or restricted while towing, install extended side view mirrors on your vehicle, even if not required.
- Do not tow a trailer during the first 800 km (500 mi) of vehicle use to prevent damage to vehicle.
- Do not drive over 80 km/h (50 mph) and do not make starts at full throttle during the first 800 km (500 mi) of trailer towing.
- Tow in D (Drive).

The following driver assistance features should be turned off when towing a trailer, and may turn off automatically when a trailer is detected:

- Park Assist
- Reverse Automatic Braking (RAB)
- Rear Cross Traffic Alert (RCTA)
- Rear Cross Traffic Braking (RCTB)
- Lane Change Alert (LCA)
- Super Cruise and Adaptive Cruise Control (ACC), unless equipped with trailering functionality, see *Adaptive Cruise Control (Advanced)* ⇨ 173.

Automatic Emergency Braking (AEB) and Front Pedestrian Braking (FPB) should be set to Alert unless equipped with Super Cruise.

Do not use Automatic Parking Assist (APA) while towing a trailer.

Towing a trailer requires experience. The combination of the vehicle and trailer is longer and not as responsive as the vehicle itself. Become familiar with handling and braking of the combination by driving on a level road surface before driving on public roads.

The trailer structure, the tyres, and the brakes must all be rated to carry the intended load. Inadequate trailer equipment can cause the combination to operate in an unexpected or unsafe manner. Before driving, inspect all trailer hitch parts and attachments, safety chains, electrical connectors, lamps, tyres, and mirrors. See *Towing Equipment* ⇨ 231. If the trailer has electric brakes, start the combination moving and then manually apply the trailer brake controller to check the trailer brakes work. During the trip, occasionally check that the load and trailer are secure and that the lamps and any trailer brakes are working.

Towing with a Stability Control System

When towing, the stability control system might be heard. The system reacts to vehicle movement caused by the trailer, which mainly occurs during cornering. This is normal when towing heavier trailers.

Following Distance

Stay at least twice as far behind the vehicle ahead as you would when driving without a trailer to help to avoid heavy braking and sudden turns.

Overtaking

More overtaking distance is needed when towing a trailer. The combination of the vehicle and trailer will not accelerate as quickly and is much longer than the vehicle alone. You need to drive much farther beyond the overtaken vehicle before turning back into the lane. Overtaking on level roadways. Avoid overtaking on hills if possible.

Reversing

Hold the bottom of the steering wheel with one hand. To move the trailer to the left, move that hand to the left. To move the trailer to the right, move that hand to the right. Always reverse slowly and, if possible, have someone guide you.

Making Turns

Caution

Turn more slowly and make wider arcs when towing a trailer to prevent damage to your vehicle. Making very sharp turns could cause the trailer to make contact with the vehicle.

Make wider turns than normal when towing, so the trailer does not go over soft shoulders, over kerbs, or collide with road signs, trees, or other objects. Always indicate turns well in advance. Do not steer or brake suddenly.

Driving on Grades

Reduce speed and maintain gear before starting down a long or steep downhill gradient. See *Hill and Mountain Roads* ⇨ 154.

The vehicle can tow in D (Drive).

Viewing Systems

If equipped, the viewing systems on the vehicle can improve visibility while hitching, reversing, and driving with a trailer. See *Advanced Driver Assistance Systems* ⇨ 182.

Parking on Hills

Warning

To prevent serious injury or death, always park your vehicle and trailer on a level surface when possible.

When parking your vehicle and your trailer on a hill:

1. Press and hold the brake pedal, but do not shift into P (Park). Turn the wheels toward the curb if facing downhill or toward traffic if facing uphill.
2. Have someone place chocks under the trailer wheels.
3. When the wheel chocks are in place, gradually release the brake pedal to allow the chocks to absorb the load of the trailer.
4. Reapply the brake pedal. Then apply the electric parking brake and shift into P (Park).

5. Release the brake pedal.

Leaving After Parking on a Hill

1. Apply and hold the brake pedal.
 - Start the vehicle.
 - Shift into a gear.
 - Release the parking brake.
2. Release the brake pedal.
3. Drive slowly until the trailer is clear of the chocks.
4. Stop and have someone pick up and store the chocks.

Maintenance when Trailer Towing

The vehicle needs to be serviced more often when used to tow trailers. See *Maintenance Schedule* ⇨ 289. It is especially important to check the cooling system and brake system before and during each trip.

Check periodically that all nuts and bolts on the trailer hitch are tight.

Cooling the Vehicle when Trailer Towing

The cooling system may temporarily overheat during severe operating conditions. See *Cooling System* ⇨ 246.

Trailer Towing

Caution

Towing a trailer improperly can damage the vehicle and result in costly repairs not covered by the vehicle warranty. To tow a trailer correctly, follow the directions in this section and see your Cadillac Service Centre for important information about towing a trailer with the vehicle.

The following information contains trailering tips and safety rules important for your safety and that of your passengers. Read this section carefully before towing a trailer.

Trailer Weight

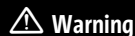

Warning

Never exceed the towing capacity for your vehicle.

Safe trailer towing requires monitoring of the weight, speed, altitude, road gradients, outside temperature, dimensions of the front of the trailer, and how frequently the vehicle is used to tow a trailer.

Trailer Weight Ratings

When towing a trailer, the combined weight of the vehicle, vehicle contents, trailer, and trailer contents must be below all of the maximum weight ratings for the vehicle, including:

- Gross Combined Weight Rating (GCWR)
- Gross Vehicle Weight Rating (GVWR)
- Maximum Trailer Weight Rating
- Gross Axle Weight Rating-Rear (GAWR-RR)
- Maximum Trailer Tongue Weight Rating

See “Trailer Brakes” under *Towing Equipment* ⇨ 231 to determine if brakes are required based on the trailer weight.

The only way to be sure the weight ratings are not exceeded is to verify with a scale.

 **Warning**

You and others could be seriously injured or killed if the trailer is too heavy or the trailer brakes are inadequate for the load. The vehicle may be damaged, and the repairs would not be covered by the vehicle warranty.

Only tow a trailer if all the steps in this section have been followed. Ask your Cadillac Service Centre for advice and information about towing a trailer.

Gross Combined Weight Rating (GCWR)

GCWR is the total allowable weight of the completely loaded vehicle and trailer including any passengers, cargo, equipment, and accessories. Do not exceed the GCWR for your vehicle. The GCWR for the vehicle is in the following Tow Rating Chart.

Gross Vehicle Weight Rating (GVWR)

For information about the vehicle's maximum load capacity, see *Vehicle Load Limits* ⇨ 155. When calculating the GVWR with a trailer attached, the trailer tongue weight must be included as part of the weight the vehicle is carrying.

Maximum Trailer Weight

The maximum trailer weight rating is calculated assuming five passengers are in the tow vehicle and it has all the required trailering equipment. The weight of additional optional equipment and cargo in the tow vehicle must be subtracted from the maximum trailer weight.

Use the tow rating chart to determine how much the trailer can weigh, based on the vehicle model and options.

Vehicle	Maximum Trailer Weight	GCWR	Maximum Tongue Weight
LYRIQ AWD	1588 kg (3,500 lb)	4788 kg (10,555 lb)	64 kg (140 lb)

Maximum Trailer Tongue Weight

The maximum trailer tongue weight rating is the allowable trailer tongue weight that the vehicle can support using a conventional trailer hitch. It may be necessary to reduce the overall trailer weight to stay within the maximum trailer tongue weight rating while still maintaining the correct trailer load balance.

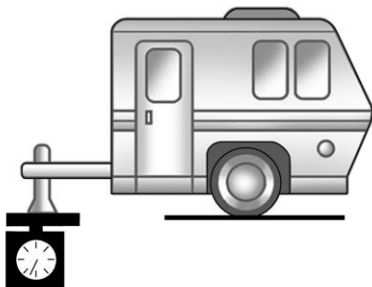

The trailer tongue weight contributes to the Gross Vehicle Weight (GVW). GVW includes the CURB WEIGHT of your vehicle, any passengers, cargo, equipment and the trailer tongue weight. Vehicle options, passengers, cargo, and equipment reduce the maximum allowable tongue weight the vehicle can carry, which also reduces the maximum allowable trailer weight.

Trailer Load Balance

The correct trailer load balance must be maintained to ensure trailer stability. Incorrect load balance is a leading cause of trailer sway.

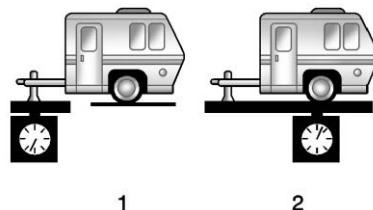

The trailer tongue weight (1) should be 4% of the loaded trailer weight (2). Some specific trailer types, such as boat trailers, fall outside of this range. Always refer to the trailer owner's manual for the recommended trailer tongue weight for each trailer. Never exceed the maximum loads for your vehicle, hitch and trailer.

The trailer load balance percentage is calculated as: weight (1) divided by weight (2) times 100.

After loading the trailer, separately weigh the trailer and trailer tongue. Calculate the trailer load balance percentage to see if the weights and distribution are appropriate for your vehicle. If the trailer weight is too high, it may be possible to transfer some of the cargo into your vehicle. If the trailer tongue weight is too high or too low, it may be possible to rearrange some of the cargo inside the trailer.

Do not exceed the maximum allowable tongue weight for your vehicle. Use the shortest hitch extension available to position the hitch ball closer to your vehicle. This will help reduce the effect of the trailer tongue weight on the trailer hitch and the rear axle.

If a cargo carrier is used in the trailer hitch receiver, choose a carrier that positions the load as close to the vehicle as possible. Make sure the total weight, including the carrier, is no more than half of the maximum allowable tongue weight for the vehicle or 227 kg (500 lb), whichever is less.

Rear Gross Axle Weight Rating (GAWR-RR)

The GAWR-RR is the total weight the vehicle's rear axle can support. Do not exceed the GAWR-RR for the vehicle, with the tow vehicle and trailer fully loaded for the trip, including the weight of the trailer tongue. If using a weight-distributing hitch, do not exceed the GAWR-RR before applying the weight distribution spring bars.

For additional assistance with trailering or additional information, see your Cadillac Service Centre.

Towing Equipment

Hitches

Warning

In order to avoid serious injury or property damage, always follow the hitch manufacturer's instructions when securing your draw bar/coupling device to the vehicle's hitch receiver.

(Continued)

Warning (Continued)

Ensure that the draw bar/coupling device is secured with a locking retainer pin or other means such that rotation of the pin or locking mechanism will not cause the pin to back out or loosen during use. Failure to correctly secure the draw bar/coupling device to the receiver can result in separation of the hitch/receiver while towing.

Always use the correct hitch equipment for your vehicle. Crosswinds, getting overtaken by large trucks, and rough roads can affect the vehicle and trailer combination.

Proper hitch equipment for your vehicle helps maintain control of the vehicle-trailer combination. Many trailers can be towed using a weight-carrying hitch with a drawbar coupling. See "Maximum Trailer Tongue Weight Rating" under *Trailer Towing* ⇨ 228 for weight limits with various hitch types.

Never attach rental hitches or other bumper-type hitches. Only use frame-mounted hitches that do not attach to the bumper.

Consider using mechanical sway controls with any trailer. Ask a trailering professional about sway controls or see the trailer manufacturer's recommendations and instructions.

Maximum permissible mass of the coupling device (if not fitted by the manufacturer)

If an aftermarket coupling device is added to the vehicle, the combined mass of the vehicle, passengers, cargo in the vehicle, mass of the coupling device, and trailer tongue load must not exceed the gross vehicle mass rating.

The GM approved trailer hitch installation requires removal of the rear bumper beam and installation of reinforcement plates on the rail assemblies at the attachments points.

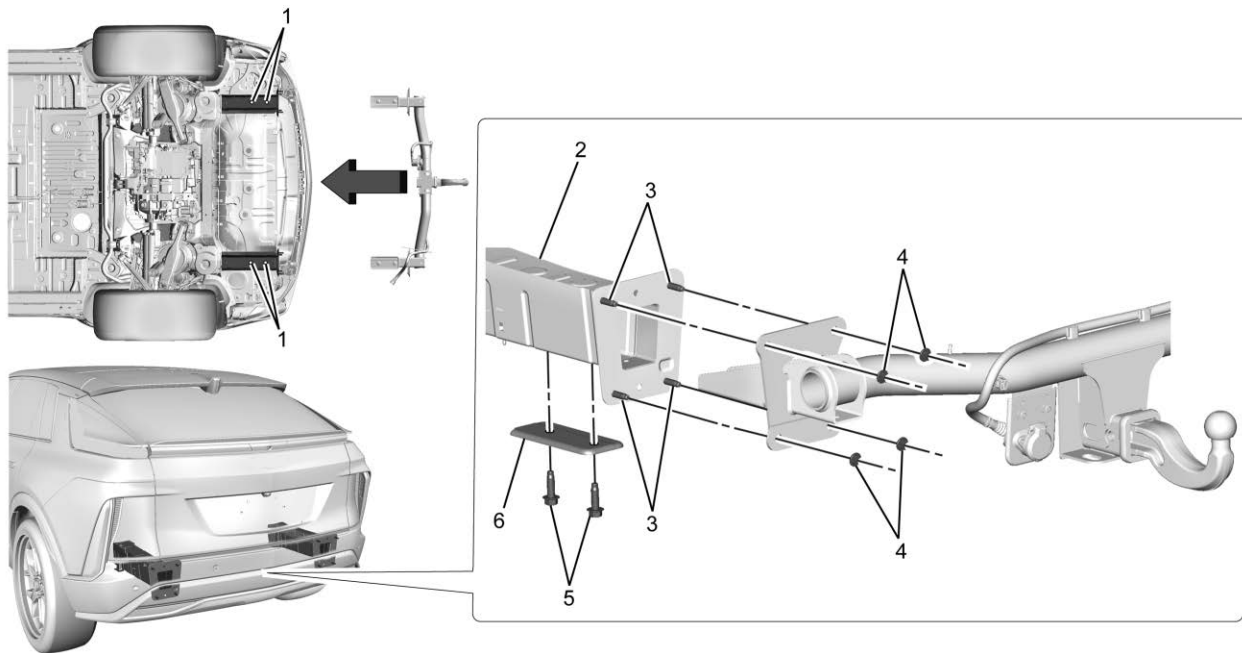

234 Driving and Operating

1. Front Attachment Points (4) – M12 Fasteners required
2. Rail Assembly
3. Rear Attachment Points (8) – M10 Studs present on the rails (M10 nuts needed)
4. Nuts – M10
5. Fasteners – M12
6. Reinforcement Plate (4 mm (0.2 in) thick x 83 mm (3.3 in) wide x 186 mm (7.3 in) long)

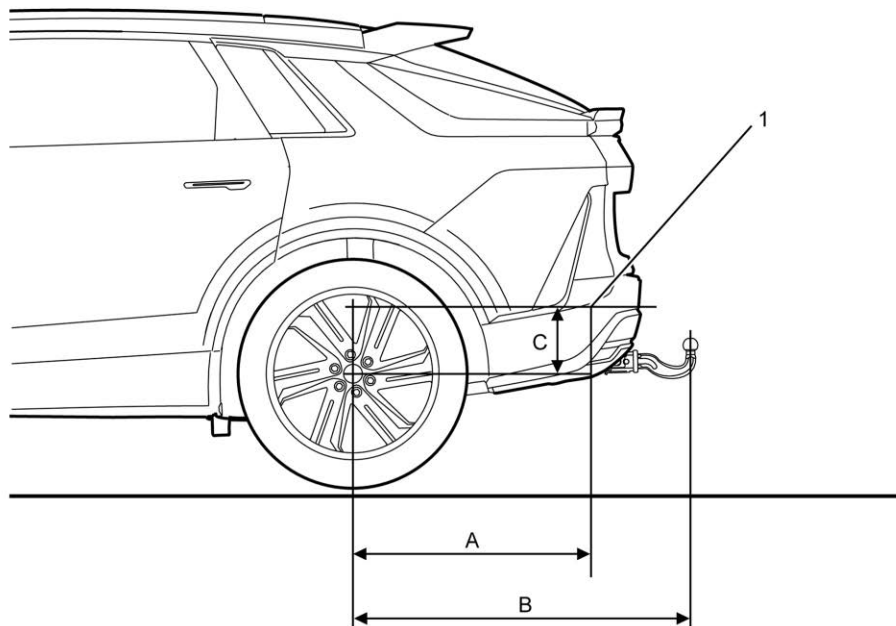

236 Driving and Operating

- A. 604 mm (23.8 in) – Two through rail holes, 104 mm (4.1 in) apart
- B. 1167 mm (45.9 in)
- C. 113 mm (4.4 in)

Installing a Drawbar Coupling

A drawbar coupling is provided for vehicles designed to tow a trailer. If equipped, trailering information is provided with the vehicle documents.



The drawbar coupling is stored in the rear of the vehicle under the load floor. Press the handle and pull up the load floor to access.

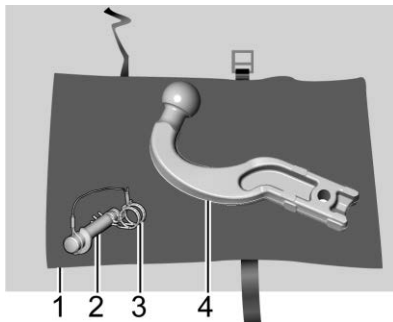

1. Storage Bag
2. Pin
3. Clip
4. Drawbar Coupling

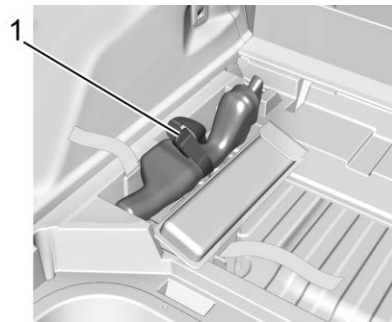

1. Release the strap (1) from the cargo hook.
2. Remove the storage bag.
3. Remove the pin and the drawbar coupling from the storage bag.

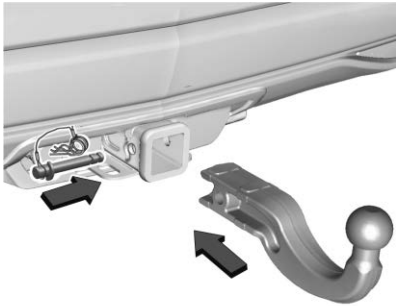

4. Install the drawbar coupling into the hitch.
5. Remove the clip from the pin.
6. Install the pin through the hole in the hitch and the drawbar coupling.

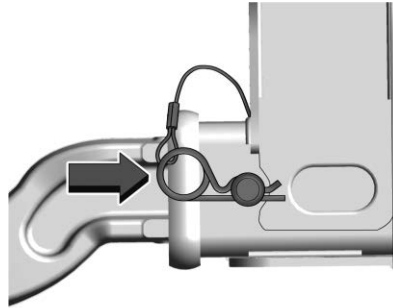

7. Install the clip into the pin.

Removing and Storing the Drawbar Coupling

Warning

An unsecured drawbar coupling could be thrown about the vehicle during a collision or sudden manoeuvre. Someone could be injured. Always properly secure the drawbar coupling in its storage bag in the rear storage compartment under the load floor when not in use.

1. Remove the clip from the pin.
2. Remove the pin from the hitch and drawbar coupling.

3. Remove the drawbar coupling from the hitch.

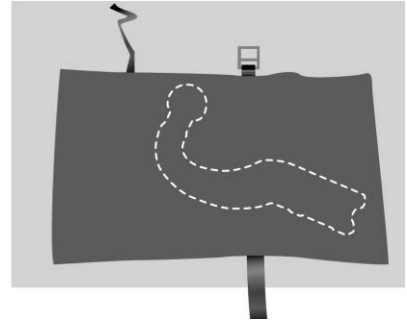

4. Install the clip onto the pin.
5. Place the assembled unit into the storage bag and pull the drawstring to close.

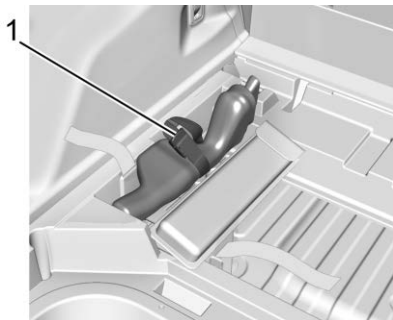

6. Install the storage bag into the compartment with the buckle forward (1).
7. Run the strap from the bag to the cargo hook.
8. Reinstall the load floor cover.

Maximum permissible mass of the coupling device (if not fitted by the manufacturer)

If an aftermarket coupling device is added to the vehicle, the combined mass of the vehicle, passengers, cargo in the vehicle, mass of the coupling device, and trailer tongue load must not exceed the gross vehicle mass rating.

Tyres

- Do not tow a trailer while using a compact spare tyre on the vehicle.
- Tyres must be properly inflated to support loads while towing a trailer. See *Tyres* ⇨ 263 for instructions on proper tyre inflation.

Trailer Brakes

Loaded trailers over 750 kg must be equipped with brake systems with brakes for each axle.

Trailer Wiring Harness

Basic Trailer Wiring

If the vehicle is not equipped with a trailer connector on the rear bumper, a 13-wire trailering harness is tied to the vehicle frame. The harness requires the installation of a trailer connector, which is available through your Cadillac Service Centre.

Use only a round, 13-wire connector with flat blade terminals meeting SAE J2863 specifications for proper electrical connectivity.

The 13-pin harness contains the following trailer circuits:



1. Yellow – Left Indicator
2. Blue – Fog Light
3. White – Earth
4. Green – Right Indicator
5. Brown – Right Side Light
6. Red – Brake Light
7. Black – Left Side Light
8. Orange – Reverse
9. Red/Brown – Permanent Live
10. Blue/Brown – Fridge
11. Blue/White – Earth
12. None – Not Allocated
13. Green/White – Earth

Trailer Lamps

Always check that all trailer lights are working at the beginning of each trip, and periodically on longer trips.

Turn Signals When Towing a Trailer

When properly connected, the trailer indicators will illuminate to indicate the vehicle is turning, changing lanes, or stopping. When towing a trailer, the arrows on the instrument cluster will illuminate even if the trailer is not properly connected or the bulbs are burned out.

Trailer Sway Control (TSC)

Vehicles with StabiliTrak/Electronic Stability Control (ESC) have a Trailer Sway Control (TSC) feature. Trailer sway is unintended side-to-side motion of a trailer while towing. If the vehicle is towing a trailer and the TSC detects that sway is increasing, the vehicle brakes are selectively applied at each wheel, to help reduce excessive trailer sway.



If TSC is enabled, the Traction Control System (TCS)/StabiliTrak warning light will flash on the instrument cluster. Reduce vehicle speed by gradually removing your foot from the accelerator. If trailer sway continues, StabiliTrak can help slow the vehicle down. TSC will not function if StabiliTrak is turned off. See *Traction Control/Electronic Stability Control* ⇨ 170.

Warning

Trailer sway can result in a crash and in serious injury or death, even if the vehicle is equipped with TSC.

(Continued)

Warning (Continued)

If the trailer begins to sway, reduce vehicle speed by gradually removing your foot from the accelerator. Then pull over to check the trailer and vehicle to help correct possible causes, including an improperly or overloaded trailer, unsecured load, improper trailer hitch configuration, or improperly inflated or incorrect vehicle or trailer tyres. See *Towing Equipment* ⇨ 231 for trailer ratings and hitch setup recommendations.

Trailer Tyres

Always check all trailer tyre pressures before each trip when the tyres are cool. Low trailer tyre pressure is a leading cause of trailer tyre blowouts.

Trailer tyres deteriorate over time. The trailer tyre sidewall will show the week and year the tyre was manufactured. Many trailer tyre manufacturers recommend replacing tyres more than six years old.

Overloading is another leading cause of trailer tyre blow-outs. Never load your trailer with more weight than the tyres are designed to support. The load rating is located on the trailer tyre sidewall.

Always know the maximum speed rating for the trailer tyres before driving. This may be significantly lower than the vehicle tyre speed rating. The speed rating may be on the trailer tyre sidewall. If the speed rating is not shown, the default trailer tyre speed rating is 105 km/h (65 mph).

Conversions and Add-Ons

Add-On Electrical Equipment

 **Warning**

The Data Link Connector (DLC) is used for vehicle service and Emission Inspection/Maintenance testing. See *Service Vehicle Soon Light* ⇨ 93. A device connected to the DLC — such as an aftermarket fleet or driver-behaviour tracking device — may interfere with vehicle systems. This could affect vehicle operation and cause a
(Continued)

Warning (Continued)

crash. Such devices may also access information stored in the vehicle's systems.

Caution

Some electrical equipment can damage the vehicle or cause components not to work and would not be covered by the vehicle warranty. Always check with your Cadillac Service Centre before adding electrical equipment.

Add-on equipment can drain the vehicle's 12-volt battery, even if the vehicle is not operating.

When adding electrical equipment, it should only be connected using the accessory power outlets. The maximum power that can be supplied by one accessory power outlet or spread across all three is 200 watts or 15 amps. Exceeding 200 watts or 15 amps may cause erratic vehicle operation.

The vehicle has an airbag system. Before attempting to add anything electrical to the vehicle, see *Servicing the Airbag-Equipped Vehicle* ⇨ 57 and *Adding Equipment to the Airbag-Equipped Vehicle* ⇨ 58.

Vehicle Care

General Information

General Information	242
Accessories and Modifications	242

Vehicle Checks

Doing Your Own Service Work	242
Bonnet	243
Underhood Compartment Overview ...	245
Cooling System	246
Washer Fluid	247
Brakes	247
Brake Fluid	248
Battery	249
Park Brake and P (Park) Mechanism Check	251
Wiper Blade Replacement	252
Windscreen Replacement	252
Gas Strut(s)	252

Headlamp Aiming

Front Headlight Aiming	253
------------------------------	-----

Bulb Replacement

LED Lighting	253
--------------------	-----

Electrical System

High Voltage Devices and Wiring	254
Electrical System Overload	254
Fuses and Circuit Breakers	255

Underbonnet Compartment Fuse Block	256
Instrument Panel Fuse Block	260

Wheels and Tyres

Tyres	263
Winter Tyres	264
Self-Sealing Tyres	264
Low-Profile Tyres	264
Summer Tyres	265
Tyre Pressure	265
Tyre Pressure for High-Speed Operation	266
Tyre Pressure Monitor System	267
Tyre Pressure Monitor Operation	268
Tyre Inspection	270
Tyre Rotation	271
When It Is Time for New Tyres	272
Buying New Tyres	272
Different Size Tyres and Wheels	273
Wheel Alignment and Tyre Balance ...	274
Wheel Replacement	274
Tyre Traction Devices	274
If a Tyre Goes Flat	275

Jump Starting

Jump Starting	275
---------------------	-----

Towing the Vehicle

Transporting a Disabled Vehicle	278
---------------------------------------	-----

Appearance Care

Exterior Care	280
Interior Care	284
Floor Mats	287

General Information

For service and parts needs, visit your Cadillac Service Centre. You will receive genuine parts and trained and supported service people.

Accessories and Modifications

Adding non-GM accessories or making modifications to the vehicle can affect vehicle performance and safety, including such things as airbags, braking, stability, ride and handling, emissions systems, aerodynamics, durability, Advanced Driver Assistance Systems, and electronic systems like antilock brakes, traction control, and stability control. These accessories or modifications could even cause malfunction or damage not covered by the vehicle warranty.

Damage to suspension components caused by modifying vehicle height outside of factory settings will not be covered by the vehicle warranty.

Damage to vehicle components resulting from modifications or the installation or use of non-GM certified parts, including control module or software modifications, is not

covered under the terms of the vehicle warranty and may affect remaining warranty coverage for affected parts.

GM Accessories are designed to complement and function with other systems on the vehicle. See your Cadillac Service Centre to accessorise the vehicle using genuine GM Accessories installed by a Cadillac Service Centre technician.

Also, see *Adding Equipment to the Airbag-Equipped Vehicle* ⇨ 58.

Vehicle Checks

Doing Your Own Service Work

Warning

Never try to do your own service on high voltage battery components. You can be injured and the vehicle can be damaged if you try to do your own service work. Service and repair of these high voltage battery components should only be performed by a trained Cadillac Service Centre technician with the proper knowledge and tools.

(Continued)

Warning (Continued)

Exposure to high voltage can cause shock, burns, and even death. The high voltage components in the vehicle can only be serviced by technicians with special training.

High voltage components are identified by labels. Do not remove, open, take apart, or modify these components. High voltage cable or wiring has orange covering. Do not probe, tamper with, cut, or modify high voltage cable or wiring.

Warning

Unexpected wheel motion and/or direction when one or more wheels are off the ground for service work may result in injury. The vehicle may:

- Allow the wheels to rotate unexpectedly in either direction regardless of mode selection.
- Allow the wheels to rotate in reaction to attempts to rotate the tyre(s) manually.

(Continued)

Warning (Continued)

- Resist attempts to rotate the wheels manually.

Before lifting the vehicle to do your own service work, turn the vehicle off or place the vehicle in the Service Mode. To place the vehicle in Service Mode, with the vehicle off and the brake pedal not applied, press and hold POWER for more than five seconds.

⚠ Warning

It can be dangerous to work on your vehicle if you do not have the proper knowledge, service manual, tools, or parts. Always follow owner's manual procedures and consult the service manual for your vehicle before doing any service work.

If doing some of your own service work, use the proper service manual. It tells you much more about how to service the vehicle than this manual can.

This vehicle has an airbag system. Before attempting to do your own service work, see *Servicing the Airbag-Equipped Vehicle* ⇨ 57.

Bonnet**⚠ Warning**

Components under the bonnet can get hot. To help avoid the risk of burning unprotected skin, never touch these components until they have cooled, and always use a glove or towel to avoid direct skin contact.

To open the bonnet:

1. Pull the bonnet release handle on the lower left side of the instrument panel.



2. Release the handle, then pull the handle again to fully open the bonnet.
3. Go to the front of the vehicle and lift the bonnet open.

To close the bonnet:

1. Be sure all filler caps are on properly, and all tools are removed.
2. Lower the bonnet down until the strut system is no longer holding up the bonnet.
3. Allow the bonnet to fall. Check to make sure the bonnet is latched completely. Repeat this process with additional force if necessary.

4. If the bonnet does not latch, a message will display on the Driver Information Centre (DIC) indicating the vehicle will not shift out of (P) Park. To override this function, press and hold the brake pedal until override completion message is displayed on DIC.

 **Warning**

Do not drive the vehicle if the bonnet is not latched completely. The bonnet could open fully, block your vision, and cause a crash. You or others could be injured. Always close the bonnet completely before driving.

Underhood Compartment Overview

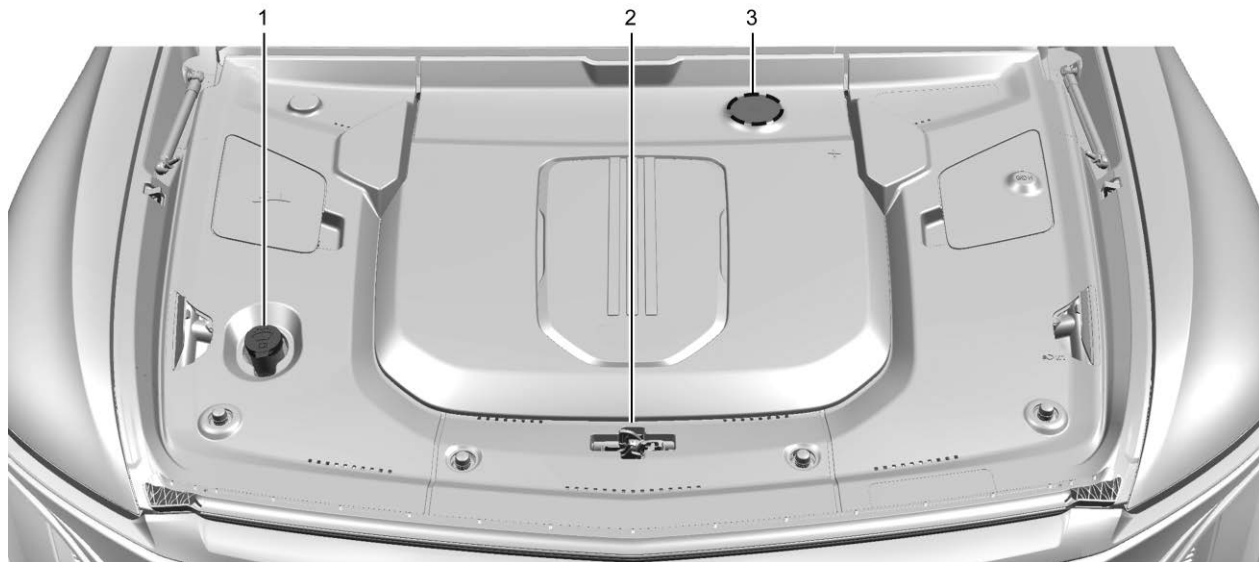

1. Windscreen Washer Fluid Reservoir. See *Washer Fluid* ⇨ 247.
2. Bonnet Latch.
3. Brake Fluid Reservoir. See *Brake Fluid* ⇨ 248.

Cooling System

It is not necessary to regularly check coolant unless a leak is suspected or an unusual noise is heard. A coolant loss could indicate a problem. Have it inspected and repaired by your Cadillac Service Centre.

During vehicle operation and also during charging, the high voltage battery cells in the vehicle are kept within a normal operating temperature range. If the temperature rises above this temperature, the battery cooling system turns on the air conditioning compressor and cools the coolant until the correct temperature is reached. If the temperature falls below this temperature, a high voltage heater, located outside the battery on a cradle, heats the coolant until the correct temperature is reached.

The cooling system allows the vehicle to maintain the correct working temperature.

Checking Coolant

The coolant needs to be replaced at the appropriate interval. See *Maintenance Schedule* ⇨ 289.

The coolant reservoir is in the underbonnet compartment. See *Underhood Compartment Overview* ⇨ 245.

To access the coolant reservoir under the bonnet, the right side access cover needs to be removed.

1. Park on a level surface and turn the vehicle off.
2. Open the bonnet. See *Bonnet* ⇨ 243.

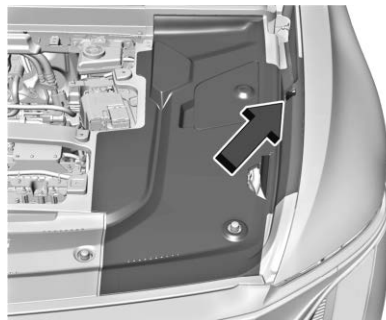

3. The coolant reservoir is under a cover and side extension/shield in the underbonnet compartment. Unclip the right side of the shield and remove the right side access cover.

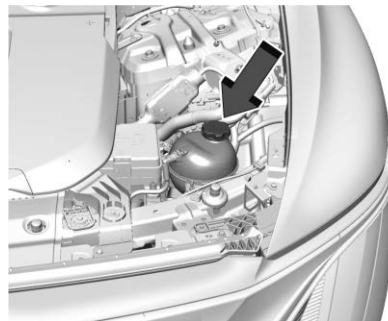

4. After the system has completely cooled, check that the coolant level in the reservoir.

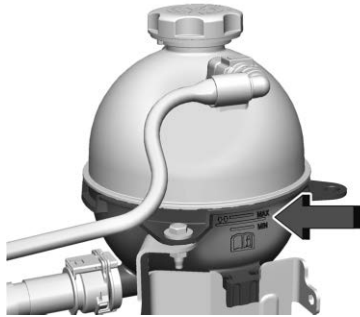

5. If the coolant level is not visible or needs to be adjusted within the reservoir, contact your Cadillac Service Centre.

Washer Fluid

What to Use

When windscreen washer fluid is needed, be sure to read the manufacturer's instructions before use. If operating the vehicle in an area where the temperature may fall below freezing, use a fluid that has sufficient protection against freezing.

Adding Washer Fluid

If the vehicle is equipped with a washer fluid level indicator, and the washer fluid reservoir is low, a message displays on the Driver Information Centre (DIC). See *Driver Information Centre (DIC)* ⇨ 105 for more information.

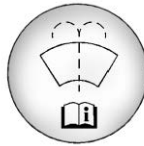

Open the cap with the washer symbol on it. Add washer fluid until the tank is full. See *Underhood Compartment Overview* ⇨ 245 for reservoir location.

Caution

- Do not use washer fluid that contains any type of water repellent coating. This can cause the wiper blades to chatter or skip.
- Do not use engine coolant (antifreeze) in the windscreen washer. It can damage the windscreen washer system and paint.

(Continued)

Caution (Continued)

- Do not mix water with ready-to-use washer fluid. Water can cause the solution to freeze and damage the washer fluid tank and other parts of the washer system.
- When using concentrated washer fluid, follow the manufacturer instructions for adding water.
- Fill the washer fluid tank only three-quarters full when it is very cold. This allows for fluid expansion if freezing occurs, which could damage the tank if it is completely full.

Brakes

Disc brake linings have built-in wear indicators that make a high-pitched warning sound when the brake linings are worn and new linings are needed. The sound can come and go or can be heard all the time when the vehicle is moving, except when applying the brake pedal firmly.

Warning

The brake wear warning sound means that soon the brakes will not work well. That could lead to a crash. When the brake wear warning sound is heard, have the vehicle serviced.

Caution

Continuing to drive with worn-out brake linings could result in expensive brake repairs.

Some driving conditions or climates can cause brake squeal when the brakes are first applied, which clears up following several brake applications. This does not mean something is wrong with the brakes.

Properly torqued wheel nuts are necessary to help prevent brake pulsation. When tyres are rotated, inspect the brake linings for wear and evenly tighten wheel nuts in the correct sequence to torque specifications. See *Capacities and Specifications* ⇨ 295.

Brake pads should be replaced as complete axle sets.

Brake Pedal Travel

See your Cadillac Service Centre if the brake pedal does not return to normal height, or if there is a rapid increase in pedal travel. This could be a sign that brake service may be required.

Replacing Brake System Parts

Always replace brake system parts with new, approved replacement parts. If this is not done, the brakes may not work properly. The braking performance can change in many ways if the wrong brake parts are installed or if parts are improperly installed.

Brake Fluid

The brake master cylinder reservoir is filled with GM approved DOT 4 brake fluid as indicated on the reservoir cap. See *Underhood Compartment Overview* ⇨ 245 for the location of the reservoir.

Checking Brake Fluid

With the vehicle in P (Park) on a level surface, the brake fluid level should be between the minimum and maximum marks on the brake fluid reservoir.

There are only two reasons why the brake fluid level in the reservoir may go down:

- Normal brake lining wear. When new linings are installed, the fluid level goes back up.
- A fluid leak in the brake hydraulic system. Have the brake hydraulic system fixed. With a leak, the brakes will not work well.

Always clean the brake fluid reservoir cap and the area around the cap before removing it.

Do not top off the brake fluid. Adding fluid does not correct a leak. If fluid is added when the linings are worn, there will be too much fluid when new brake linings are installed. Add or remove fluid, as necessary, only when work is done on the brake hydraulic system.

When the brake fluid falls to a low level, the brake warning light comes on. See *Brake System Warning Light* ⇨ 93.

Brake fluid absorbs water over time which degrades the effectiveness of the brake fluid. Replace brake fluid at the specified intervals to prevent increased stopping distance. See *Maintenance Schedule* ⇨ 289.

What to Add

Use only GM approved DOT 4 brake fluid from a clean, sealed container. See *Recommended Fluids and Lubricants* ⇨ 291.

⚠ Warning

The wrong or contaminated brake fluid could result in damage to the brake system. This could result in the loss of braking leading to a possible injury. Always use the proper GM approved brake fluid.

Caution

If brake fluid is spilled on the vehicle's painted surfaces, the paint finish can be damaged. Immediately wash off any painted surface.

Battery

This vehicle has a high voltage battery and a standard 12-volt battery.

See your Cadillac Service Centre if either the 12-volt or high voltage battery needs service.

12-Volt Battery

The original equipment battery is maintenance free. Do not remove the cap and do not add fluid.

Do not disconnect the 12-volt battery during storage.

Refer to the replacement number shown on the original battery label when a new 12-volt battery is needed. The vehicle has an Absorbent Glass Mat (AGM)/Valve regulated lead acid battery (VRLA) 12-volt battery. Installation of a standard 12-volt battery will result in reduced 12-volt battery life.

Some 12-volt chargers have an AGM battery setting. This setting limits the charge voltage to 14.8 volts and helps extend the battery life. If available, use the AGM setting when charging the battery.

High Voltage Battery

Only a trained service technician should inspect, test, or replace the high voltage battery. The Cadillac Service Centre has information on how to recycle the high

voltage battery. There is also information available at <https://www.recyclemybattery.com>.

⚠ Warning

Damage to the high voltage battery or high voltage system can create a risk of electric shock, overheating, or fire.

If the vehicle is damaged from a moderate to severe crash, flood, fire, or other event, the vehicle should be inspected as soon as possible. Until the vehicle has been inspected, store it outside at least 15 m (50 ft) from any structure or anything that can burn. Ventilate the vehicle by opening a window or a door.

If the vehicle is in a crash, the sensing system may shut down the high voltage system. When this occurs, the high voltage battery is disconnected and the vehicle will not start. The SERVICE VEHICLE SOON message in the Driver Information Centre (DIC) will display. Before the vehicle can operate again, it must be serviced at your Cadillac Service Centre.

Keep the vehicle plugged in, even when fully charged, to keep the high voltage battery temperature ready for the next drive. This is important when outside temperatures are extremely hot or cold.

Propulsion power may be reduced in extremely cold temperatures, or if the high voltage battery is too cold. The message BATTERY TOO COLD, PLUG IN TO WARM will display. If the message displays, a level 2 charger is required to heat the battery to a minimum temperature to enable propulsion or charging.

A vehicle cover, which can reduce sun loading on the vehicle and improve high voltage battery life, is available from your Cadillac Service Centre.

 **Warning**

This vehicle is equipped with high voltage battery thermal detection, mitigation, and notification software. If the high voltage battery overheats, it may create a risk of a vehicle fire and may result in damage to property, serious injury, or death.

(Continued)

Warning (Continued)

If the high voltage battery overheats, an audible alarm may sound, a message may display on the Driver Information Centre (DIC), and OnStar may be called. To alert others outside your vehicle, the horn may sound, and the lights may flash.

If driving, pull over as soon as possible to a safe location at least 50 feet (15 m) away from any structure or anything that may burn. Park your vehicle, apply the parking brake, and turn the vehicle off. Open a window or door for ventilation.

Remove the remote key and move yourself and others to a safe, upwind location away from the vehicle. Do not return to the vehicle or attempt to restart or drive the vehicle.

Call emergency services and inform them that an electrical vehicle high voltage battery is overheating.

Never attempt to put out a vehicle fire.

(Continued)

Warning (Continued)

Your vehicle must be towed to an authorised Cadillac Service Centre to have the high voltage battery inspected before the vehicle can be operated again.

Vehicle Storage

The best way to store the vehicle for any length of time is to plug in the charging cable and leave it plugged in. The vehicle monitors and maintains the 12-volt battery daily. It is okay to leave the vehicle plugged in for extended periods of time. Once charged to full, very little energy is required to maintain the 12-volt battery and high voltage battery.

If it is not possible to charge the vehicle with the charging cable left plugged in, be sure to fully charge the high voltage battery before storing. The vehicle will stop maintenance of the 12-volt battery if the high voltage battery state of charge gets too low.

When storing the vehicle on a long-term basis:

- Keep the high voltage battery state of charge at 30%.

- Attach an AGM/VRLA compatible battery tender or trickle charger to the 12-volt battery.
- Keep the remote key more than 3 m (10 ft) away from the vehicle.

12-Volt Battery

Warning

Batteries have acid that can burn you and gas that can explode. You can be hurt badly if you are not careful.

Always wear eye protection. Follow instructions carefully when working around a battery.

Battery posts, terminals and related accessories contain lead and lead compounds which can cause cancer and reproductive harm. Wash hands after handling.

Do not disconnect the 12-volt battery during storage.

A trickle charger may be attached to the 12-volt battery terminals or trickle charge from the underbonnet remote positive (+)

and negative (-) terminals. See *Jump Starting* ⇨ 275 for location of these terminals.

Caution

The vehicle is equipped with an AGM/VRLA 12-volt battery, which can be damaged by using the incorrect type of trickle charger. An AGM/VRLA-compatible charger must be used, with the appropriate setting selected. Follow the trickle charger manufacturer instructions.

With a trickle charger connected to the 12-volt battery, the vehicle will still monitor the 12-volt battery daily, but it will not use energy from the high voltage battery for maintenance.

High Voltage Battery

After extended storage, it is possible that the vehicle may not operate. If this happens, the high voltage battery may need to be plugged in and charged.

Park Brake and P (Park) Mechanism Check

Warning

When you are doing this check, the vehicle could begin to move. You or others could be injured and property could be damaged. Make sure there is room in front of the vehicle in case it begins to roll. Be ready to apply the regular brake at once should the vehicle begin to move.

Park on a fairly steep hill, with the vehicle facing downhill. Keeping your foot on the regular brake, apply the Electric Parking Brake (EPB).

- To check the EPB's holding ability: With the propulsion system active and the electric drive unit in N (Neutral), slowly remove foot pressure from the foot brake pedal. Do this until the vehicle is held by the EPB only.
- To check the P (Park) mechanism's holding ability: With the propulsion system active, shift to P (Park). Then release the EPB and slowly remove foot pressure from the regular brake pedal.

Contact your Cadillac Service Centre if service is required.

Wiper Blade Replacement

Windscreen wiper blades should be replaced periodically. See the *Maintenance Schedule* ⇨ 289.

Replacement blades come in different types and are removed in different ways. For proper type and length, see *Maintenance Replacement Parts* ⇨ 292.

Caution

Allowing the wiper arm to touch the windscreen when no wiper blade is installed could damage the windscreen. Any damage that occurs would not be covered by the vehicle warranty. Do not allow the wiper arm to touch the windscreen.

To replace the windscreen wiper blade:

1. Pull the windscreen wiper assembly away from the windscreen.

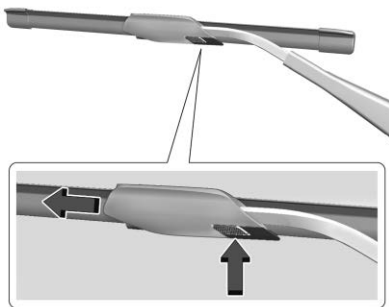

2. Press the button in the middle of the wiper arm connector, and pull the wiper blade away from the arm connector.
3. Remove the wiper blade.
4. Reverse Steps 1–3 for wiper blade replacement.

Windscreen Replacement

Advanced Driver Assistance Systems

If the windscreen needs to be replaced and the vehicle is equipped with a front camera sensor for the Advanced Driver Assistance Systems, a GM replacement windscreen is recommended. The replacement windshield must be installed according to GM specifications for proper alignment. If it is

not, error messages may display, or these systems may not work properly or at all. See your Cadillac Service Centre for proper windscreen replacement.

Acoustic and Heated Wiper Park (HWP) Windscreen

The vehicle is equipped with an acoustic and Heated Wiper Park (HWP) windscreen. If the windscreen needs replacement, make sure to use a GM compatible acoustic and HWP windscreen to retain its features

Gas Strut(s)

Your vehicle may be equipped with gas strut(s) to provide assistance in lifting and holding open the bonnet/trunk/tailgate system in the fully open position.

Warning

If the gas struts that hold open the bonnet, boot, and/or tailgate fail, you or others could be seriously injured. Take the vehicle to your Cadillac Service Centre for service immediately. Visually inspect the gas struts for signs of wear, cracks, or other damage periodically. Check to make sure the bonnet/boot/tailgate is

(Continued)

Warning (Continued)

held open with enough force. If struts are failing to hold the bonnet/boot/tailgate, do not operate. Have the vehicle serviced.

Caution

Do not apply tape or hang any objects from gas struts. Also do not push down or pull on gas struts. This may cause damage to the vehicle.

See *Maintenance Schedule* ⇨ 289.



Bonnet

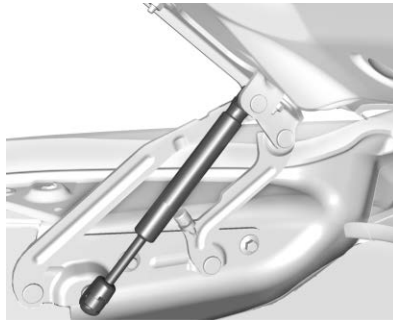

Boot



Tailgate

Headlamp Aiming**Front Headlight Aiming**

Headlamp alignment has been preset and should need no further adjustment.

If the vehicle is damaged in a crash, the headlamp alignment may be affected. If adjustment to the headlights is necessary, see your Cadillac Service Centre.

Bulb Replacement**LED Lighting**

This vehicle is equipped with LED light sources for all exterior lights.

The light assemblies do not contain any serviceable light sources (e.g., incandescent bulbs).

For replacement of any LED lighting assembly, contact your Cadillac Service Centre.

Electrical System

High Voltage Devices and Wiring

Warning

Exposure to high voltage can cause shock, burns, and even death. The high voltage components in the vehicle can only be serviced by technicians with special training.

High voltage components are identified by labels. Do not remove, open, take apart, or modify these components. High voltage cable or wiring has orange covering or labels. Do not probe, tamper with, cut, or modify high voltage cable or wiring.

Electrical System Overload

The vehicle has fuses and circuit breakers to protect against an electrical system overload.

When the current electrical load is too heavy, the circuit breaker opens and closes, protecting the circuit until the current load returns to normal or the problem is fixed.

This greatly reduces the chance of circuit overload and fire caused by electrical problems.

Fuses and circuit breakers protect the wires that provide the power to the devices in your vehicle.

If there is a problem on the road and a fuse needs to be replaced, the same amperage fuse can be borrowed. Choose some feature of the vehicle that is not needed to use and replace it as soon as possible.

To check a fuse, look at the band inside the fuse. If the band is broken or melted, replace the fuse. Be sure to replace a bad fuse with a fuse of the identical size and rating.

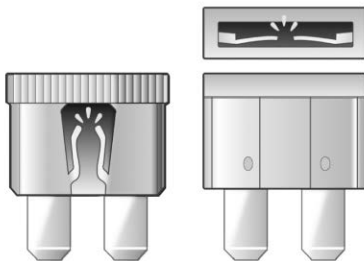

Replacing a Blown Fuse

1. Turn off the vehicle.
2. Locate the fuse puller in the underbonnet compartment fuse block.

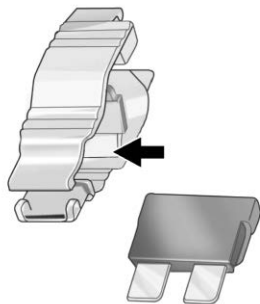
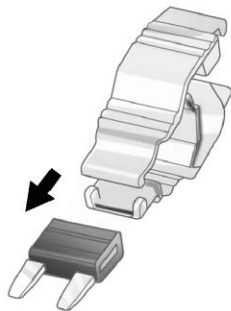

3. Use the fuse puller to remove the fuse from the top or side, as shown above.

4. If the fuse must be replaced immediately, borrow a replacement fuse with the same amperage from the fuse block. Choose a vehicle feature that is not needed to safely operate the vehicle. Repeat Steps 2-3.
5. Insert the replacement fuse into the empty slot of the blown fuse.

At the next opportunity, see a Cadillac Service Centre to replace the blown fuse.

Headlamp Wiring

An electrical overload may cause the lamps to go on and off, or in some cases to remain off. Have the headlamp wiring checked right away if the lamps go on and off or remain off.

Windscreen Wipers

If the wiper motor overheats due to heavy snow or ice, the windscreen wipers will stop until the motor cools and will then restart.

Although the circuit is protected from electrical overload, overload due to heavy snow or ice may cause wiper linkage damage. Always clear ice and heavy snow from the windscreen before using the windscreen wipers.

If the overload is caused by an electrical problem and not snow or ice, be sure to get it fixed.

Fuses and Circuit Breakers

The wiring circuits in the vehicle are protected from short circuits by a combination of fuses and circuit breakers. This greatly reduces the chance of damage caused by electrical problems.

Danger

Fuses and circuit breakers are marked with their ampere rating. Do not exceed the specified amperage rating when replacing fuses and circuit breakers. Use of an oversized fuse or circuit breaker can result in a vehicle fire. You and others could be seriously injured or killed.



 **Warning**

Installation or use of fuses that do not meet GM's original fuse specifications is dangerous. The fuses could fail, and result in a fire. You or others could be injured or killed, and the vehicle could be damaged.

See *Accessories and Modifications* ⇨ 242 and *General Information* ⇨ 242.

To check or replace a blown fuse, see *Electrical System Overload* ⇨ 254.

Underbonnet Compartment Fuse Block

To Access:

1. Open the bonnet. See *Bonnet* ⇨ 243.

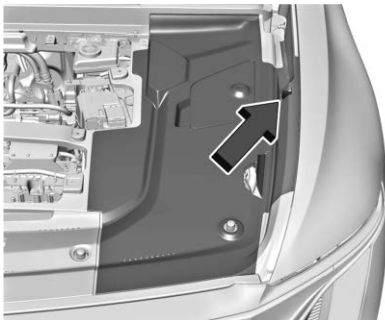

2. The Underbonnet Compartment Fuse Block is under a cover and side extension/shield in the underbonnet compartment. Unclip right side of shield and remove the right side access cover.



3. Remove the bolt to access the fuse block.

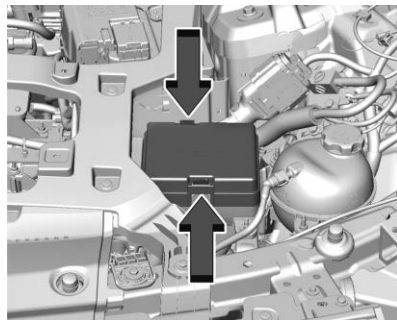

4. To open the fuse block cover, press the clips at the side and back and pull the cover up.

Caution

Spilling liquid on any electrical component on the vehicle may damage it. Always keep the covers on any electrical component.

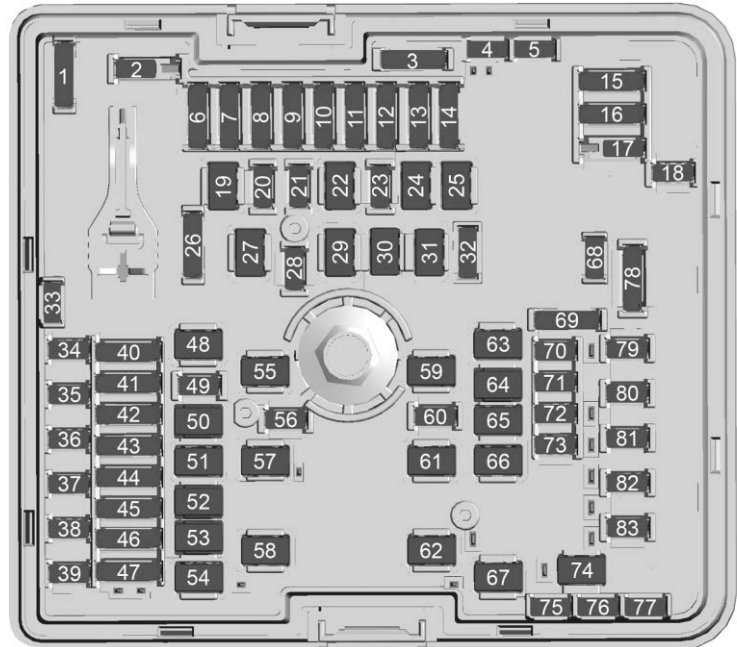

A fuse puller is in the underbonnet compartment fuse block.

The vehicle may not be equipped with all of the fuses and features shown.

Fuses	Usage
F01	Spare
F02	-

Fuses	Usage	Fuses	Usage	Fuses	Usage
F03	Spare	F11	-	F22	AC/DC INV MDL – Alternate Current/Direct Current Inverter Module
F04	Spare		ECP_S & OBCM 2 – Electrification Control Processor	F23	-
F05	Spare	F12	(Traction Power Inverter Module 2) & On Board Charging Module 2	F24	-
F06	MSM/MEMORY SEAT BOLSTER – Memory Seat Module/Memory Seat Bolster	F13	-	F25	-
	-	F14	-	F26	Spare
	PEEV/PCEV & ECFV/CHFV – Primary Evaporator Expansion Valve/Primary Chiller Expansion Valve and External Condenser Flow Valve/Condensing Heater Flow Valve	F15	TRLR PRK LIGHTS – Trailer Park Lights	F27	-
F07			-	F28	ETC MDL – Electronic Toll Control Module
	MTR MAIN COOL VLV – Motor Main Coolant Valve	F16	TRLR REV LIGHT – Trailer Reverse Light	F29	-
F08			-	F30	Rear Cargo APO – Rear Cargo Auxiliary Power Socket
	-	F17	-		TRLR INTERFACE MDL BATT SOURCE 1 – Trailer Interface Module Battery Source 1
	Motor: PECP & Motor: ESSCP – Power Electronics Coolant Pump and Energy Storage System Coolant Pump	F18	GLBX DR RELSE – Glove Box Release	F31	
F09		F19	-	F32	Spare
	-	F20	-	F33	Spare
F10		F21	CHARGE PORT DR MTR – Charge Port Door Motor	F34	ELM 5 – Exterior Lighting Module 5
	-			F35	ELM 4 – Exterior Lighting Module 4

Fuses	Usage
F36	-
F37	-
F38	ELM 7 – Exterior Lighting Module 7
F39	ELM 3 – Exterior Lighting Module 3
F40	ECP_E_Batt SOURCE 1 & ECP_E_Batt SOURCE 3 – Electrification Control Processor (Traction Power Inverter Module 1) Source 3 and 1
F41	DSP & AIR SPRINGS 2 – Door Switch Panel and Suspension Control Levelling 2
F42	SEAT POS SW & VKM SNSR/RLH SNSR – Seat Position Switch and Virtual Key Module Sensor/Rain Light Humidity Sensor
F43	SCL & CHIM MDL – Steering Column Lock and Charge Interface Module

Fuses	Usage
F44	PSM & AERO SH – Power Sounder Module and Aero Shutter
F45	RFA MDL & HFC MDL – Remote Function Actuator Module and Handsfree Closure Module
F46	AFL/AHL & PFA Module – Adaptive Forward Lighting/Automatic Headlight Levelling and Pedestrian Friendly Alert Module
F47	LIT GRILLE/FR PRK EMBLEM & SADS – Lit Grille/Front Park Emblem and Semi Active Damping System
F48	PWR T/GATE – Power Tailgate
F49	-
F50	MTR WDW LIFTER LT – Motor Window Lifter Left
F51	AIR SPRINGS 1 – Suspension Control Levelling 1
F52	MTR WDW LIFTER RT – Motor Window Lifter Right

Fuses	Usage
F53	FRT WPR – Front Wiper
F54	TRLR HEAVYDUTY/TRLR EUROPE – Trailer Battery
F55	-
F56	FOLD SEAT RT MTR – Fold Seat Right Motor
F57	EBCM– Electronic Brake Control Module
F58	FRT BLWR MTR – Front Blower Motor
F59	-
F60	Horn
F61	Rear Defog
F62	REAR BLWR MTR – Rear Blower Motor
F63	MTR S/ROOF & SUNSHD – Motor Sunroof and Motor Sunshade
F64	PWR SEAT DRVR – Power Seat Driver
F65	PWR SEAT PASS – Power Seat Passenger

Fuses	Usage
F66	CRFM – Condenser Radiator Fan Module
F67	Heated Wiper
F68	Spare
F69	Spare
F70	RELAY'S COIL
F71	REAR HTD/SEAT 2 – Rear Heated Seat 2
F72	FRT HTD/SEAT 1 – Front Heated Seat 1
F73	FOLD SEAT LT MTR – Fold Seat Left Motor
F74	TRLR INTERFACE MDL BATT SOURCE 2 – Trailer Interface Module Battery Source 2
F75	Spare
F76	Spare
F77	Spare
F78	TRLR ST/TRN LT & TRLR ST/TRN RT – Trailer Stop Turn Left and Trailer Stop Turn Right

Fuses	Usage
F79	REAR HTD/SEAT 1 – Rear Heated Seat 1
F80	FRT HTD/SEAT 2 – Front Heated Seat 2
F81	OUT OF PRK DSBL – Out of Park Disable
F82	Wash Pump (Front)
F83	Camera Wash

Instrument Panel Fuse Block

The instrument panel fuse block is to next to the glove box.



To Access the Fuses:

1. Remove the panel, starting at the top.
2. Once the panel clips disengage, the tabs along the bottom of the door can disengage from the instrument panel to remove the door.

To reinstall the door, place the bottom tabs into the slots, and rotate the door into position, engaging the clips.

See a Cadillac Service Centre if additional assistance is needed.



The vehicle may not be equipped with all of the fuses and features shown.

Fuses	Usage
F1	-

Fuses	Usage
F2	APO/CIGAR LTR – Auxiliary Power Socket Instrument Panel/Cigar Lighter
F3	-
F4	USB PORT/APO AC 150W – Universal Serial Bus Port/ Auxiliary Power socket Alternating Current 150W
F5	STRG COL LOCK – RUN/ CRANK Steering Column Lock
F6	ELM 1– Exterior Lighting Module 1
F7	AMP-BASE – Amplifier-Base
F8	RT DR LATCH – Right Door Latch
F9	LT DR LATCH – Left Door Latch
F10	STRG COL POS MDL – Steering Column Position Module
F11	ACP 4 –ADAS Compute Platform 4
F12	-

Fuses	Usage
F13	EUROPE-TRLR CON & ECP_E/ECP_S/VICM – RUN/ CRANK Europe – Trailer Control and Electrification Control Processor (Traction Power Inverter 1 and 2)/ Vehicle Integration Control Module
F14	HEADLIGHTS – RUN/CRANK Headlights
F15	HDLP RT –Headlight Right
F16	STRG COL/CLOCK SPRING – Steering Column Lock/Clock Spring
F17	SEAT FAN PASS & SEAT FAN DRVR – RUN/CRANK Seat Fan Passenger and Seat Fan Driver
F18	VCD & SRR –Virtual Cockpit Display and Short Range Radar

Fuses	Usage	Fuses	Usage	Fuses	Usage
F19	MISC 2 & MISC 1 – RUN/ CRANK Miscellaneous 2 Switch Bank/Electronic Toll Collection/Interior Particulate Matter Sensor/ Reflective Light Auxiliary Display and Miscellaneous 1 Electronic Brake Control Module/Exterior Lighting Module/Sensing and Diagnostic Module/Inside Rear View Mirror	F23	T/LIGHT RT & T/LIGHT LT – Tail Light Right and Tail Light Left	F26	ECP_E_BATT 2/ACEC & HUD/HVAC DISPLAY – Electrification Control Processor Battery 2/Air Condition Electric Compressor and Heads-Up Display/Heating, Ventilation and Air Conditioning Display
F20	BCM 1 & VICM – Body Control Module 1 and Vehicle Integration Control Module	F24	UPA/APA/SBZA & SDM/ AOS – Universal Park Assist/Automatic Park Assist/Side Blind Zone Alert and Sensing Diagnostic Module/Automatic Occupant Sensing Module	F27	BCM 3 – Body Control Module 3
F21	LRR-RR & EPBS/ESM – Long Range Radar – Rear and Electric Park Brake Switch/ Electronic Transmission Range Select Shifter Module	F25	ACP 2/EOCM_LC/FCM/MFC & DMS/CGM/DLC/VDM – ADAS Compute Platform 2/ External Object Calculating Module/Front Camera Module/Multi Function Control and Driver Monitoring System/Central Gateway Module/ Diagnostic Link Connector/ Vehicle Data Monitor	F28	BCM 2 – Body Control Module 2
F22	VKM/VKBM/AUX JACK & ACP3 – Virtual Key Module/Virtual Key Backup Module/Auxiliary Jack and ADAS Compute Platform 3			F29	AMP-UPLEVEL – Amplifier-U- level
				F30	BCM 4 – Body Control Module 4
				F31	VPM/SD CARD/ILSS/OHC – Video Processing Module/ SD Card/Indicator Light and Solar Sensor/Over Head Console
				F32	HSWM – Heated Steering Wheel Module

Fuses	Usage
F33	LRR FR/LIDAR – Long Range Radar Front/Light Detection and Ranging
F34	ELM 2 – Exterior Lighting Module 2
F35	HDLP LT – Headlight Left
F36	VCU BATT 1 – Virtual Cockpit Unit Battery 1
F37	TCP (OnStar) – Telematics Communication Platform
F38	WCM – Wireless Charger Module
F39	HI VOLTAGE SYS LCKOUT – High Voltage System Lockout
F40	VCU Batt 2 – Virtual Cockpit Unit Battery 2
F41	ELM 6 – Exterior Lighting Module 6
F42	-

Wheels and Tyres

Tyres

Every new GM vehicle has high-quality tyres made by a leading tyre manufacturer. See the warranty manual for information regarding the tyre warranty and where to get service. For additional information refer to the tyre manufacturer.

Warning

- Poorly maintained and improperly used tyres are dangerous.
- Overloading the tyres can cause overheating as a result of too much flexing. There could be a blowout and a serious crash. See *Vehicle Load Limits* ⇨ 155.
- Underinflated tyres pose the same danger as overloaded tyres. The resulting crash could cause serious injury. Check all tyres frequently

(Continued)

Warning (Continued)

to maintain the recommended pressure. Tyre pressure should be checked when the tyres are cold.

- Overinflated tyres are more likely to be cut, punctured, or broken by a sudden impact - such as when hitting a pothole. Keep tyres at the recommended pressure.
- Worn or old tyres can cause a crash. If the tread is badly worn, replace them.
- Replace any tyres that have been damaged by impacts with potholes, curbs, etc.
- Improperly repaired tyres can cause a crash. Only your Cadillac Service Centre or an authorised tyre service centre should repair, replace, remove and install the tyres.

(Continued)

Warning (Continued)

- Do not spin the tyres in excess of 56 km/h (35 mph) on slippery surfaces such as snow, mud, ice, etc. Excessive spinning may cause the tyres to explode.

See *Tyre Pressure for High-Speed Operation* ⇨ 266 for inflation pressure adjustment for high-speed driving.

Winter Tyres

This vehicle was not originally equipped with winter tyres. Winter tyres are designed for increased traction on snow and ice-covered roads. Consider installing winter tyres on the vehicle if frequent driving on ice or snow covered roads is expected. See your Cadillac Service Centre for details regarding winter tyre availability and proper tyre selection. Also, see *Buying New Tyres* ⇨ 272.

With winter tyres, there may be decreased dry road traction, increased road noise and shorter tread life. After changing to winter tyres, be alert for changes in the vehicle handling and braking.

If using winter tyres:

- Use tyres of the same brand and tread type on all four wheel positions.
- Use only radial ply tyres of the same size, load range and speed rating as the original equipment tyres.

Winter tyres with the same speed rating as the original equipment tyres may not be available for H, V, W, Y and ZR speed rated tyres. If winter tyres with a lower speed rating are chosen, never exceed the tyre's maximum speed capability.

Self-Sealing Tyres

This vehicle may have self-sealing tyres. These tyres have a material inside that can seal punctures from common road hazards, such as nails and screws, in the tread area. The tyre may lose air pressure if the sidewall is damaged or the tread puncture is too large. If the Tyre Pressure Monitor System indicates the tyre pressure is low, inspect the tyre for damage and inflate it to the recommended pressure. If the tyre is unable to maintain the recommended pressure, contact the nearest authorised GM servicing facility immediately for inspection

and repair or replacement. To locate the nearest GM servicing facility, call GM Customer Assistance.

Caution

Do not drive on a deflated self-sealing tyre as this could damage the tyre. Make sure the tyre is inflated to the recommended pressure or have it immediately repaired or replaced.

When tyre replacement is needed, replace with a self-sealing tyre, because the vehicle does not come with a spare tyre or tyre changing equipment.

Low-Profile Tyres

If the vehicle has 265/50R20 or 275/45R21 size tyres, they are classified as low-profile tyres.

Caution

Low-profile tyres are more susceptible to damage from road hazards or curb impact than standard profile tyres. Tyre and/or wheel assembly damage can occur when coming into contact with road hazards like potholes, or sharp edged objects,

(Continued)

Caution (Continued)

or when sliding into a kerb. The warranty does not cover this type of damage. Keep tyres set to the correct inflation pressure and when possible, avoid contact with kerbs, potholes, and other road hazards.

Summer Tyres

This vehicle may come with 265/50R20 or 275/45R21 high performance summer tyres. These tyres have a special tread and compound that are optimised for maximum dry and wet road performance. This special tread and compound will have decreased performance in cold climates, and on ice and snow. It is recommended that winter tyres be installed on the vehicle if frequent driving at temperatures below approximately 5 °C (40 °F) or on ice or snow covered roads is expected. See *Winter Tyres* ⇨ 264.

Caution

High performance summer tires have rubber compounds that lose flexibility and may develop surface cracks in the tread area at temperatures below -7 °C

(Continued)

Caution (Continued)

(20 °F). Always store high performance summer tires indoors and at temperatures above -7 °C (20 °F) when not in use. If the tires have been subjected to -7 °C (20 °F) or less, let them warm up in a heated space to at least 5 °C (40 °F) for 24 hours or more before being installed or driving a vehicle on which they are installed. Do not apply heat or blow heated air directly on the tyres. Always inspect tyres before use. See *Tyre Inspection* ⇨ 270.

Tyre Pressure

Tyres need the correct amount of air pressure to operate effectively.

 Warning

Neither tyre underinflation nor overinflation is good. Underinflated tyres, or tyres that do not have enough air, can result in:

- Tyre overloading and overheating, which could lead to a blowout

(Continued)

Warning (Continued)

- Premature or irregular wear
- Poor handling
- Reduced fuel economy for internal combustion engine vehicles
- Reduced range for electric vehicles

Overinflated tyres, or tyres that have too much air, can result in:

- Unusual wear
- Poor handling
- Rough ride
- Needless damage from road hazards

The Tyre and Loading Information label on the vehicle indicates the original equipment tyres and the correct cold tyre inflation pressures. The recommended pressure is the minimum air pressure needed to support the vehicle's maximum load carrying capacity. See *Vehicle Load Limits* ⇨ 155.

How the vehicle is loaded affects vehicle handling and ride comfort. Never load the vehicle with more weight than it was designed to carry.

When to Check

Check the pressure of the tyres once a month or more.

How to Check

Use a good quality pocket-type gauge to check tyre pressure. Proper tyre inflation cannot be determined by looking at the tyre. Check the tyre inflation pressure when the tyres are cold, meaning the vehicle has not been driven for at least three hours or no more than 1.6 km (1 mi).

Remove the valve cap from the tyre valve stem. Press the tyre gauge firmly onto the valve to get a pressure measurement. If the cold tyre inflation pressure matches the recommended pressure on the Tyre and Loading Information label, no further adjustment is necessary. If the inflation pressure is low, add air until the recommended

pressure is reached. If the inflation pressure is high, press on the metal stem in the centre of the tyre valve to release air.

Recheck the tyre pressure with the tyre gauge.

Refit the valve caps on the valve stems to keep out dirt and moisture. Use only valve caps designed for the vehicle by GM. TPMS sensors could be damaged and would not be covered by the vehicle warranty.

Tyre Pressure for High-Speed Operation

Warning

Driving at high speeds, 160 km/h (100 mph) or higher, puts additional strain on tyres. Sustained high-speed driving causes excessive heat build-up and can cause sudden tyre failure. This could cause a crash, and you or others could be killed. Some high-speed rated tyres require inflation pressure adjustment for high-speed operation. When speed limits

(Continued)

Warning (Continued)

and road conditions allow the vehicle to be driven at high speeds, make sure the tyres are rated for high-speed operation, are in excellent condition, and are set to the correct cold tyre inflation pressure for the vehicle load.

Vehicles with tyre sizes listed in the High Speed Operation Inflation Pressures table require inflation pressure adjustment when driving the vehicle at speeds of 160 km/h (100 mph) or higher. Set the cold tyre inflation pressure to the corresponding value in the table for the tyre size on the vehicle.

High Speed Operation Inflation Pressures	
Tyre Size	Cold Inflation Pressure kPa (psi)
265/50R20 SL 107H	270 kPa (39 psi)
275/45R21 XL 110V	270 kPa (39 psi)
275/45R21 SL 107V	270 kPa (39 psi)
275/40R22 XL 107H	310 kPa (45 psi)
275/40R22 XL 107V	310 kPa (45 psi)

Return the tyres to the recommended cold tyre inflation pressure when high-speed driving has ended. See *Vehicle Load Limits* ⇨ 155 and *Tyre Pressure* ⇨ 265.

Tyre Pressure Monitor System

Caution

Modifications made to the Tyre Pressure Monitor System (TPMS) by anyone other than an authorised service facility may void authorisation to use the system.

The Tyre Pressure Monitor System (TPMS) uses radio and sensor technology to check tyre pressure levels. The TPMS sensors

monitor the air pressure in your vehicle's tyres and transmit tyre pressure readings to a receiver located in the vehicle.

Each tyre, including the spare (if provided), should be checked monthly when cold and inflated to the inflation pressure recommended by the vehicle manufacturer on the vehicle placard or tyre inflation pressure label. (If your vehicle has tyres of a different size than the size indicated on the vehicle placard or tyre inflation pressure label, you should determine the proper tyre inflation pressure for those tyres.)

As an added safety feature, your vehicle has been equipped with a tyre pressure monitoring system (TPMS) that illuminates a low tyre pressure telltale when one or more of your tyres is significantly under-inflated.

Accordingly, when the low tyre pressure telltale illuminates, you should stop and check your tyres as soon as possible, and inflate them to the proper pressure. Driving on a significantly under-inflated tyre causes the tyre to overheat and can lead to tyre failure. Under-inflation also reduces energy efficiency and tyre tread life, and may affect the vehicle's handling and stopping ability.

Please note that the TPMS is not a substitute for proper tyre maintenance, and it is the driver's responsibility to maintain

correct tyre pressure, even if under-inflation has not reached the level to trigger illumination of the TPMS low tyre pressure telltale.

Your vehicle has also been equipped with a TPMS malfunction indicator to indicate when the system is not operating properly. The TPMS malfunction indicator is combined with the low tyre pressure telltale. When the system detects a malfunction, the telltale will flash for approximately one minute and then remain continuously illuminated. This sequence will continue upon subsequent vehicle start-ups as long as the malfunction exists.

When the malfunction indicator is illuminated, the system may not be able to detect or signal low tyre pressure as intended. TPMS malfunctions may occur for a variety of reasons, including the installation of replacement or alternate tyres or wheels on the vehicle that prevent the TPMS from functioning properly. Always check the TPMS malfunction telltale after replacing one or more tyres or wheels on your vehicle to ensure that the replacement or alternate tyres and wheels allow the TPMS to continue to function properly.

See *Tyre Pressure Monitor Operation* ⇨ 268 for additional information.

See *Declaration of Conformity* ⇨ 296.

Tyre Pressure Monitor Operation

This vehicle may have a Tyre Pressure Monitor System (TPMS). The TPMS is designed to warn the driver when a low tyre pressure condition exists. TPMS sensors are mounted onto each tyre and wheel assembly, excluding the spare tyre and wheel assembly. The TPMS sensors monitor the air pressure in the tyres and transmit the tyre pressure readings to a receiver located in the vehicle.



When a low tyre pressure condition is detected, the TPMS illuminates the low tyre pressure warning light on the instrument cluster. If the warning light comes on, stop as soon as possible and inflate the tyres to the recommended pressure shown on the Tyre and Loading Information label. See *Vehicle Load Limits* ⇨ 155.

A message to check the pressure in a specific tyre displays in the Driver Information Centre (DIC). The low tyre pressure warning light and the DIC warning message come on each time the vehicle is turned on until the tyres are inflated to the correct inflation pressure. Using the DIC, tyre pressure levels can be viewed. For additional information and details about the DIC operation and displays see *Driver Information Centre (DIC)* ⇨ 105.

The low tyre pressure warning light may come on in cool weather when the vehicle is first started, and then turn off as the vehicle is driven. This could be an early indicator that the air pressure is getting low and needs to be inflated to the proper pressure.

A Tyre and Loading Information label, attached to your vehicle, shows the size of the original equipment tyres and the correct inflation pressure for the tyres when they are cold. See *Vehicle Load Limits* ⇨ 155, for an example of the Tyre and Loading Information label and its location. Also see *Tyre Pressure* ⇨ 265.

The TPMS can warn about a low tyre pressure condition but it does not replace normal tyre maintenance. See *Tyre Inspection* ⇨ 270, *Tyre Rotation* ⇨ 271, and *Tyres* ⇨ 263.

Caution

Tyre sealant materials are not all the same. A non-approved tyre sealant could damage the TPMS sensors. TPMS sensor damage caused by using an incorrect tyre sealant is not covered by the vehicle warranty. Always use only the GM approved tyre sealant available through your Cadillac Service Centre or included in the vehicle.

TPMS Malfunction Light and Message

The TPMS will not function properly if one or more of the TPMS sensors are missing or inoperable. When the system detects a malfunction, the low tyre pressure warning light flashes for about one minute and then stays on for the remainder of the time the vehicle is on. A DIC warning message also displays. The malfunction light and DIC warning message come on each time the

vehicle is turned on until the problem is corrected. Some of the conditions that can cause these to come on are:

- One of the road tyres has been replaced with the spare tyre. The spare tyre does not have a TPMS sensor. The malfunction light and DIC message should go off after the road tyre is replaced and the sensor matching process is performed successfully. See "TPMS Sensor Matching Process" later in this section.
- The TPMS sensor matching process was not done or not completed successfully after rotating the tyres. The malfunction light and the DIC message should go off after successfully completing the sensor matching process. See "TPMS Sensor Matching Process" later in this section.
- One or more TPMS sensors are missing or damaged. The malfunction light and the DIC message should go off when the TPMS sensors are installed and the sensor matching process is performed successfully. See your Cadillac Service Centre for service.
- Replacement tyres or wheels do not match the original equipment tyres or wheels. Tyres and wheels other than

those recommended could prevent the TPMS from functioning properly. See *Buying New Tyres* ⇨ 272.

- Operating electronic devices or being near facilities using radio wave frequencies similar to the TPMS could cause the TPMS sensors to malfunction.

If the TPMS is not functioning properly it cannot detect or signal a low tyre pressure condition. See your Cadillac Service Centre for service if the TPMS malfunction light and DIC message come on and stay on.

Tyre Fill Alert (If Equipped)

This feature provides visual and audible alerts outside the vehicle to help when inflating an underinflated tyre to the recommended cold tyre pressure.

When the low tyre pressure warning light comes on:

1. Park the vehicle in a safe, level place.
2. Apply the parking brake firmly.
3. Place the vehicle in P (Park).
4. Add air to the tyre that is underinflated. The indicator lamp will flash.

When the recommended pressure is reached, the horn sounds once and the indicator lamp will stop flashing and briefly turn solid.

Repeat these steps for all underinflated tyres that have illuminated the low tyre pressure warning light.

Warning

Overinflating a tyre could cause the tyre to rupture and you or others could be injured. Do not exceed the maximum pressure listed on the tyre sidewall.

If the tyre is overinflated by more than 35 kPa (5 psi), the horn will sound multiple times and the indicator lamp will continue to flash for several seconds after filling stops. To release and correct the pressure, while the indicator lamp is still flashing, briefly press the centre of the valve stem. When the recommended pressure is reached, the horn sounds once.

If the indicator lamp does not flash within 15 seconds after starting to inflate the tyre, the tyre fill alert has not been activated or is not working.

If the hazard warning flashers are on, the tyre fill alert visual feedback will not work properly.

The TPMS will not activate the tyre fill alert properly under the following conditions:

- There is interference from an external device or transmitter.
- The air pressure from the inflation device is not sufficient to inflate the tyre.
- There is a malfunction in the TPMS.
- There is a malfunction in the horn or indicator lamps.
- The TPMS sensor identification code is not registered to the system.
- The TPMS sensor battery is low.

If the tyre fill alert does not operate due to TPMS interference, move the vehicle about 1 m (3 ft) back or forward and try again.

If the tyre fill alert feature is not working, use a tyre pressure gauge.

TPMS Sensor Matching Process — Auto Learn Function

Each TPMS sensor has a unique identification code. The identification code needs to be matched to a new tyre/wheel position after rotating the tyres or replacing one or more of the TPMS sensors. When a

tyre is installed, the vehicle must be stationary for about 20 minutes before the system recalculates. The following relearn process takes up to 10 minutes, driving at a minimum speed of 20 km/h (12 mph). A dash (-) or pressure value will display in the DIC. See *Driver Information Centre (DIC)* ⇨ 105. A warning message displays in the DIC if a problem occurs during the relearn process.

Tyre Inspection

We recommend that the tyres, including the spare tyre, if the vehicle has one, be inspected for signs of wear or damage at least once a month.

Replace the tyre if:

- The indicators at three or more places around the tyre can be seen.
- There is cord or fabric showing through the tyre's rubber.
- The tread or sidewall is cracked, cut, or snagged deep enough to show cord or fabric.
- The tyre has a bump, bulge, or split.

- The tyre has a puncture, cut, or other damage that cannot be repaired well because of the size or location of the damage.

Tyre Rotation

Tyres should be rotated according to the interval listed in the maintenance schedule. See *Maintenance Schedule* ⇨ 289.

Tyres are rotated to achieve a more uniform wear for all tyres. The first rotation is the most important.

Anytime unusual wear is noticed, rotate the tyres as soon as possible, check for proper tyre inflation pressure, and check for damaged tyres or wheels. If the unusual wear continues after the rotation, check the wheel alignment. See *When It Is Time for New Tyres* ⇨ 272 and *Wheel Replacement* ⇨ 274.

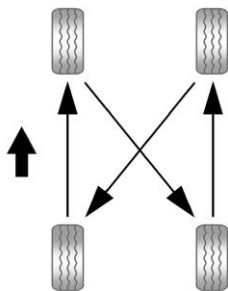

Use this rotation pattern when rotating the tyres.

Adjust the front and rear tyres to the recommended inflation pressure on the Tyre and Loading Information label after the tyres have been rotated. See *Tyre Pressure* ⇨ 265 and *Vehicle Load Limits* ⇨ 155.

Reset the Tyre Pressure Monitor System. See *Tyre Pressure Monitor Operation* ⇨ 268.

Check that all wheel nuts are properly tightened. See “Wheel Nut Torque” under *Capacities and Specifications* ⇨ 295.

Warning

Rust or dirt on a wheel, or on the parts to which it is fastened, can cause wheel nuts to become loose over time. The wheel could come off and cause a crash. When changing a wheel, remove any rust or dirt from places where the wheel attaches to the vehicle. In an emergency, a cloth or paper towel can be used; however, use a scraper or wire brush afterwards to remove all rust or dirt.

Lightly coat the inner diameter of the wheel hub opening with wheel bearing grease after a wheel change or tyre rotation to prevent corrosion or rust build-up.

Warning

Do not apply grease to the wheel mounting surface, wheel conical seats, or the wheel nuts or bolts. Grease applied to these areas could cause a wheel to become loose or detach, resulting in a collision.

When It Is Time for New Tyres

Factors, such as maintenance, temperatures, driving speeds, vehicle loading, and road conditions affect the wear rate of the tyres.

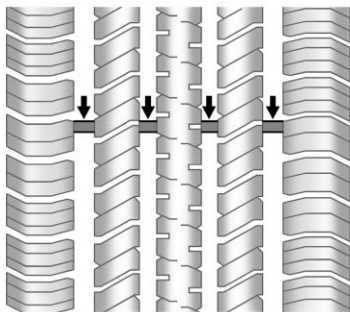

Tread wear indicators are one way to tell when it is time for new tyres. Tread wear indicators appear when the tyres have only 1.6 mm (1/16 in) or less of tread remaining. See *Tyre Inspection* ⇨ 270 and *Tyre Rotation* ⇨ 271.

The rubber in tyres ages over time. This also applies to the spare tyre, if the vehicle has one, even if it is never used. Multiple factors including temperatures, loading conditions, and inflation pressure maintenance affect how fast ageing takes place. GM

recommends that tyres, including the spare if equipped, be replaced after six years, regardless of tread wear. To identify the age of a tyre, use the tyre manufacture date, which consists of the last four digits of the DOT Tyre Identification Number (TIN) moulded into one side of the tyre sidewall. The last four digits of the TIN indicate the tyre manufacture date. The first two digits indicate the week and the last two digits, the year. For example, the third week of the year 2020 would have a 4-digit DOT date of 0320. Week 01 is the first full week (Sunday to Saturday inclusive) of each year.

Vehicle Storage

Tyres age when stored normally mounted on a parked vehicle. Park a vehicle that will be stored for at least a month in a cool, dry, clean area away from direct sunlight to slow ageing. This area should be free of grease, petrol, or other substances that can deteriorate rubber.

Parking for an extended period can cause flat spots on the tyres that may result in vibrations while driving. When storing a vehicle for at least a month, remove the tyres or raise the vehicle to reduce the weight from the tyres.

Buying New Tyres

GM has developed and matched specific tyres for the vehicle. The original equipment tyres installed were designed to meet General Motors Tyre Performance Criteria Specification (TPC Spec) system rating. When replacement tyres are needed, GM strongly recommends buying tyres with the same TPC Spec rating.

GM's exclusive TPC Spec system considers over a dozen critical specifications that impact the overall performance of the vehicle, including brake system performance, ride and handling, traction control, and tyre pressure monitoring performance. GM's TPC Spec number is moulded onto the tyre's sidewall near the tyre size.

GM recommends replacing worn tyres in complete sets of four. Uniform tread depth on all tyres will help to maintain the performance of the vehicle. Braking and handling performance may be adversely affected if all the tyres are not replaced at the same time. If proper

rotation and maintenance have been done, all four tyres should wear out at about the same time. However, if it is necessary to replace only one axle set of worn tyres, place the new tyres on the rear axle. See *Tyre Rotation* ⇨ 271.

Warning

Tyres could explode during improper service. Attempting to mount or dismount a tyre could cause injury or death. Only your Cadillac Service Centre or authorised tyre service centre should remove or install the tyres.

Warning

Mixing tyres of different sizes (other than those originally installed on the vehicle), brands, tread patterns or types may cause loss of control of the vehicle, resulting in a crash or other vehicle damage. Use the correct size, brand, and type of tyre on all wheels.

Warning

Using bias-ply tyres on the vehicle may cause the wheel rim flanges to develop cracks after many miles of driving. A tyre and/or wheel could fail suddenly and cause a crash. Use only radial-ply tyres with the wheels on the vehicle.

Winter tyres with the same speed rating as the original equipment tyres may not be available for H, V, W, Y and ZR speed rated tyres. Never exceed the winter tyres' maximum speed capability when using winter tyres with a lower speed rating.

If the vehicle tyres must be replaced with a tyre that does not have a TPC Spec number, make sure they are the same size, load range, speed rating, and construction (radial) as the original tyres.

The Tyre and Loading Information label indicates the original equipment tyres on the vehicle. See *Vehicle Load Limits* ⇨ 155.

Different Size Tyres and Wheels

If wheels or tyres are installed that are a different size than the original equipment wheels and tyres, vehicle performance, including its braking, ride and handling characteristics, stability, and resistance to rollover may be affected. If the vehicle has electronic systems such as antilock brakes, rollover airbags, traction control, electronic stability control, or All-Wheel Drive, the performance of these systems can also be affected.

Warning

If different sized wheels are used, there may not be an acceptable level of performance and safety if tyres not recommended for those wheels are selected. This increases the chance of a crash and serious injury. Only use GM specific wheel and tyre systems developed for the vehicle, and have them properly installed by a GM certified technician.

See *Buying New Tyres* ⇨ 272 and *Accessories and Modifications* ⇨ 242.

Wheel Alignment and Tyre Balance

The tyres and wheels were aligned and balanced at the factory to provide the longest tyre life and best overall performance. Adjustments to wheel alignment and tyre balancing are not necessary on a regular basis. Consider an alignment check if there is unusual tyre wear or the vehicle is significantly pulling to one side or the other. Some slight pull to the left or right, depending on the camber of the road and/or other road surface variations such as troughs or ruts, is normal. If the vehicle is vibrating when driving on a smooth road, the tyres and wheels may need to be rebalanced. See your Cadillac Service Centre for proper diagnosis.

Wheel Replacement

Replace any wheel that is bent, cracked, or badly rusted or corroded. If wheel nuts keep coming loose, the wheel, wheel bolts, and wheel nuts should be replaced. If the wheel leaks air, replace it. Some aluminium wheels can be repaired. See your Cadillac Service Centre if any of these conditions exist.

Your Cadillac Service Centre will know the kind of wheel that is needed.

Each new wheel should have the same load-carrying capacity, diameter, width, offset, and be mounted the same way as the one it replaces.

Replace wheels, wheel bolts, wheel nuts, or Tyre Pressure Monitor System (TPMS) sensors with new GM original equipment parts.

Warning

Using the wrong replacement wheels, wheel bolts, or wheel nuts can be dangerous. It could affect the braking and handling of the vehicle. Tires can lose air and cause loss of control, resulting in a crash. Always use the correct wheel, wheel bolts, and wheel nuts for replacement.

Warning

Replacing a wheel with a used one is dangerous. How it has been used or how far it has been driven may be unknown.
(Continued)

Warning (Continued)

It could fail suddenly and cause a crash. When replacing wheels, use a new GM original equipment wheel.

Caution

The wrong wheel can also cause problems with bearing life, brake cooling, speedometer or odometer calibration, headlamp aim, bumper height, vehicle ground clearance, and tyre or tyre chain clearance to the body and chassis.

Tyre Traction Devices

Caution

If the vehicle is equipped with tyre size 275/45R21, use tyre winter traction devices only where legal and only when necessary. Only use textile traction devices, such as tyre snow socks, that are the proper size for the tyres. Install them on the tyres of the front axle only. Drive slowly and follow the traction device manufacturer's instructions. Driving too
(Continued)

Caution (Continued)

fast or spinning the wheels, with the traction device installed, can damage the traction device.

If a Tyre Goes Flat

It is unusual for a tyre to blow out while driving, especially if the tyres are maintained properly. A tyre is much more likely to experience a slow leak. See *Tyres* ⇨ 263.

In the event of a blowout, follow these tips:

- A front tyre blowout causes the vehicle to pull toward the side of the flat tyre. Take your foot off the accelerator pedal and grip the steering wheel firmly. Steer to maintain lane position, and then gently brake to a stop.
- A rear blowout, particularly on a curve, acts much like a skid and may require the same correction as used in a skid. Stop pressing the accelerator pedal and steer to straighten the vehicle. It may be very bumpy and noisy. Gently brake to a stop.

The vehicle has no spare tyre, no tyre changing equipment and no place to store a tyre.

If the vehicle has self-sealing tyres, see *Self-Sealing Tyres* ⇨ 264. Tread punctures typically will not cause tyres to lose air. However, if the vehicle does get a flat tyre, there is no spare tyre, tyre changing equipment, or place to store a tyre.

⚠ Warning

Driving on a flat tyre will cause permanent damage to the tyre. Re-inflating a tyre after it has been driven on while severely underinflated or flat may cause a blowout and a serious crash. Never attempt to re-inflate a tyre that has been driven on while severely underinflated or flat. Have your Cadillac Service Centre or an authorised tyre service centre repair or replace the flat tyre as soon as possible.

If a tyre goes flat, avoid further tyre and wheel damage by driving slowly to a level place, well off the road, if possible. Turn on the hazard warning flashers. See *Hazard Lights* ⇨ 117.

Jump Starting

For more information about the vehicle battery, see *Battery* ⇨ 249.

If the battery has run down, try to use another vehicle and some jumper cables to start your vehicle. Be sure to use the following steps to do it safely.

⚠ Warning

Batteries can hurt you. They can be dangerous because:

- They contain acid that can burn you.
- They contain gas that can explode or ignite.
- They contain enough electricity to burn you.

Use eye protection when handling the battery. If you do not follow these steps exactly, some or all of these things can hurt you.

Caution

Ignoring these steps could result in costly damage to the vehicle that would not be covered by the vehicle warranty. Trying to start the vehicle by pushing or pulling it will not work, and it could damage the vehicle.

Caution

If the jump leads are connected or removed in the wrong order, electrical shorting may occur and damage the vehicle. The repairs would not be covered by the vehicle warranty. Always connect and remove the jump leads in the correct order, making sure that the cables do not touch each other or other metal.

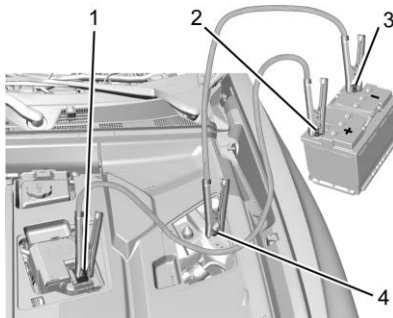
**Connection Points and Sequence**

1. Discharged Battery Positive (+) Terminal
2. Good Battery Positive (+) Terminal
3. Good Battery Negative (-) Terminal
4. Discharged Battery Negative (-) Earthing Point

The discharged battery positive (+) terminal and the discharged battery negative (-) earthing point are on the driver side of the vehicle.

The good battery negative (-) terminal and the good battery positive (+) terminal are on the battery of the vehicle providing the jump start.

The discharged battery positive (+) terminal is under a cover. Remove the cover to expose the terminal.

1. Check the other vehicle. It must have a 12-volt battery with a negative ground system.

Caution

If the other vehicle does not have a 12-volt system with a negative ground, both vehicles can be damaged. Only use a vehicle that has a 12-volt system with a negative ground for jump starting.

2. Get the vehicles close enough so the jump leads can reach, but make sure the vehicles are not touching each other.

Caution

If the vehicles touch each other while jump starting, an earth connection may occur that disables your vehicle and/or damages the electrical systems of one or both vehicles.

To avoid the possibility of the vehicles rolling, apply the parking brake firmly on both vehicles involved in the jump start procedure. Put the vehicles into P (Park).

If the other vehicle has a manual gearbox, put the vehicle in N (Neutral) before applying the parking brakes.

- Turn off both vehicles. Unplug unnecessary accessories plugged into the cigarette lighter or the accessory power outlet. Turn off the radio and all lamps that are not needed.

Caution

If any accessories are left on or plugged in during the jump starting procedure, they could be damaged. The repairs would not be covered by the vehicle warranty. Whenever possible, turn off or unplug all accessories on either vehicle when jump starting.

- Open the bonnet. See *Bonnet* ⇨ 243.

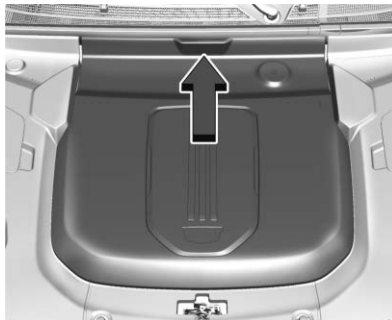

Vehicles without Underbonnet Storage

To open the lid, pull the handle to disengage the clips and remove the cover.



Vehicles with Underbonnet Storage

To open the lid, pull the handle on either side of the centre to release the latch.

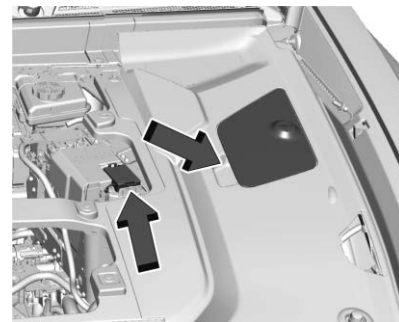

Vehicles without Underbonnet Storage

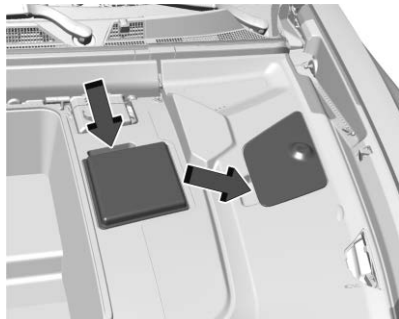

Vehicles with Underbonnet Storage

5. Remove the covers of the positive and negative terminals.
6. Locate the battery positive (+) terminal and negative (-) earthing point.
7. Check that the jump leads do not have loose or missing insulation. If they do, you could get a shock. The vehicles could be damaged too.
8. Connect one end of the red positive (+) cable to the discharged battery positive (+) terminal. Do not let the other end touch metal.
9. Connect the other end of the red positive (+) cable to the good battery positive (+) terminal.

10. Connect one end of the black negative (-) cable to the good battery negative (-) terminal.
Do not let the other end touch anything until the next step.
11. Connect the other end of the negative (-) cable to the discharged battery negative (-) earthing point.
12. Now start the vehicle with the good battery and keep the vehicle running for a while.
13. Try to start the vehicle that had the dead battery. If it will not start after a few tries, it probably needs service.

Jump Lead Removal

Reverse the sequence exactly when removing the jump leads.

After starting the disabled vehicle and removing the jump leads, allow it to idle for several minutes.

Towing the Vehicle

Transporting a Disabled Vehicle

Caution

Transporting a disabled vehicle incorrectly may cause damage to the vehicle. Use proper tyre straps to secure the vehicle to the flatbed tow truck. Do not strap or hook to any frame, underbody, or suspension component not specified below. Do not move vehicles with drive axle tyres on the ground. Damage is not covered by the vehicle warranty.

Caution

The vehicle may be equipped with an electric parking brake and/or an electronic gearchange. In the event of a loss of 12-volt battery power, the electric parking brake cannot be released, and the vehicle cannot be changed to N (Neutral). Tyre skates or dollies must be used under the non-rolling tyres to prevent damage while loading/unloading the vehicle. Dragging the vehicle will cause damage not covered by the vehicle warranty.

Caution

The vehicle may be equipped with a towing eye. Improper use of the towing eye may cause damage to the vehicle and is not covered by the vehicle warranty. If equipped, use the towing eye to load the vehicle onto a flatbed tow truck from a flat road surface, or to move the vehicle a very short distance at a walking pace. The towing eye is not designed for off-road recovery. The vehicle must be in N (Neutral) with the electric parking brake released when using the towing eye.

Contact a professional towing service if the disabled vehicle must be transported. GM recommends a flatbed tow truck to transport a disabled vehicle. Use ramps to help reduce approach angles, if necessary.

If equipped, a towing eye may be located near the spare tyre or emergency jack. Do not use the towing eye to pull the vehicle from the snow, mud, sand, or ditch. Towing eye threads may have right or left-hand threads. Use caution when installing or removing the towing eye.

The vehicle must be in N (Neutral) and the electric parking brake must be released when loading the vehicle onto a flatbed tow truck.

- If the vehicle is equipped with car wash mode and has 12-volt battery power, refer to “Car Wash Mode” under *Electric Drive Unit* ⇨ 162 to place the vehicle in N (Neutral).
- If the 12-volt battery is dead and/or the vehicle will not start, the vehicle will not move. Try to jump start the vehicle. Refer to *Jump Starting* ⇨ 275 and if the jump start is successful, retry the “Car Wash Mode” procedure.
- If jump starting is unsuccessful, the vehicle will not move. Tyre skates or dollies must be used under the non-rolling tyres to prevent vehicle damage.

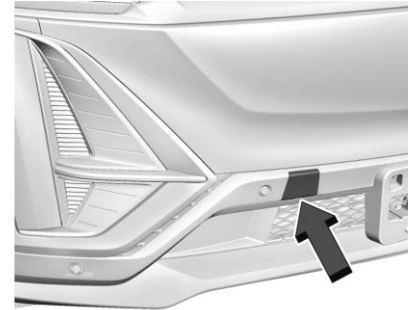
Front Tow Eye Attachment Point

1. Carefully open the cover in the fascia by using the small notch that conceals the tow eye socket.



2. Install the tow eye into the socket and turn it until it is fully tightened. When the tow eye is removed, reinstall the cover with the notch in the original position.

Rear Tow Eye Attachment Point



1. Carefully open the cover in the fascia by using the small notch that conceals the tow eye socket.



2. Install the tow eye into the socket and turn it until it is fully tightened. When the tow eye is removed, reinstall the cover with the notch in the original position.

Appearance Care

Exterior Care

Locks

Locks are lubricated at the factory. Use a de-icing agent only when absolutely necessary, and have the locks greased after using. See *Recommended Fluids and Lubricants* ⇨ 291.

Washing the Vehicle

To preserve the vehicle's finish, wash it often and out of direct sunlight.

Caution

Do not use petroleum-based, acidic, or abrasive cleaning agents as they can damage the vehicle's paint, metal, or plastic parts. If damage occurs, it would not be covered by the vehicle warranty. Approved cleaning products can be obtained from your Cadillac Service Centre. Follow all manufacturer directions regarding correct product usage, necessary safety precautions, and appropriate disposal of any vehicle care product.

Caution

Avoid using high-pressure washers closer than 30 cm (12 in) to the surface of the vehicle. Use of power washers exceeding 8 274 kPa (1,200 psi) can result in damage or removal of paint and decals.

If using an automatic car wash, follow the car wash instructions. The windscreen wiper and rear window wiper, if equipped, must

be off. Remove any accessories that may be damaged or interfere with the car wash equipment.

Rinse the vehicle well, before washing and after, to remove all cleaning agents completely. If they are allowed to dry on the surface, they could stain.

Dry the finish with a soft, clean chamois or an all-cotton towel to avoid surface scratches and water spotting.

Cleaning Underbonnet Components

Caution
<p>Do not power wash any component under the bonnet that has this  symbol.</p> <p>This could cause damage that would not be covered by the vehicle warranty.</p>

Solvents or aggressive cleaners may harm underbonnet components. Avoid using these chemicals. Water is recommended.

A pressure washer may be used, but use care when handling. The following criteria must be followed:

- Water pressure must be kept below 14,000 KPa (2,000 PSI).

- Water temperature must be below 80 °C (180 °F).
- Spray nozzle with a 40-degree wide angle spray pattern or wider must be used.
- Nozzle must be kept at least 30 cm (1 ft) away from all surfaces.

Finish Care

Application of aftermarket clearcoat sealant/wax materials is not recommended.

If painted surfaces are damaged, see your Cadillac Service Centre to have the damage assessed and repaired. Foreign materials such as calcium chloride and other salts, ice melting agents, road oil and tar, tree sap, bird droppings, chemicals from industrial chimneys, etc., can damage the vehicle's finish if they remain on painted surfaces. Wash the vehicle as soon as possible. If necessary, use non-abrasive cleaners that are marked safe for painted surfaces to remove foreign matter.

Occasional hand waxing or mild polishing should be done to remove residue from the paint finish. See your Cadillac Service Centre for approved cleaning products.

Do not apply waxes or polishes to uncoated plastic, vinyl, rubber, decals, simulated wood, or flat paint as damage can occur.

Caution
<p>Machine compounding or aggressive polishing on a base coat/clear coat paint finish may damage it. Use only non-abrasive waxes and polishes that are made for a base coat/clear coat paint finish on the vehicle.</p>

To keep the paint finish looking new, keep the vehicle garaged or covered whenever possible.

Protecting Exterior Bright Metal Mouldings

Caution
<p>Failure to clean and protect the bright metal mouldings can result in a hazy white finish or pitting. This damage would not be covered by the vehicle warranty.</p>

The bright metal mouldings on the vehicle are aluminium, chrome, or stainless steel. To prevent damage always follow these cleaning instructions:

- Be sure the moulding is cool to the touch before applying any cleaning solution.

- Use only approved cleaning solutions for aluminium, chrome, or stainless steel. Some cleaners are highly acidic or contain alkaline substances and can damage the mouldings.
- Always dilute a concentrated cleaner according to the manufacturer's instructions.
- Do not use cleaners that are not intended for automotive use.
- Use a nonabrasive wax on the vehicle after washing to protect and extend the moulding finish.

Cleaning Exterior Lamps/Lenses, Emblems, Decals, and Stripes

Use only lukewarm or cold water, a soft cloth, and a car washing soap to clean exterior lamps, lenses, emblems, decals, and stripes. Follow instructions under "Washing the Vehicle" previously in this section.

Lamp covers are made of plastic, and some have a UV protective coating. Do not clean or wipe them when dry.

Do not use any of the following on lamp covers:

- Abrasive or caustic agents.

- Washer fluids and other cleaning agents in higher concentrations than suggested by the manufacturer.
- Solvents, alcohols, or other harsh cleaners.
- Ice scrapers or other hard items.
- Aftermarket appearance caps or covers while the lamps are illuminated, due to excessive heat generated.

Caution

Failure to clean lamps properly can cause damage to the lamp cover that would not be covered by the vehicle warranty.

Caution

Using wax on low gloss black finish stripes can increase the gloss level and create a non-uniform finish. Clean low gloss stripes with soap and water only.

Air Intakes

Clear debris from the air intakes, between the bonnet and windscreen, when washing the vehicle.

Windscreen and Wiper Blades

Clean the outside of the windscreen with glass cleaner.

Clean rubber blades using a lint-free cloth or paper towel soaked with windscreen washer fluid or a mild detergent. Wash the windscreen thoroughly when cleaning the blades. Insects, road grime, sap, and a build-up of vehicle wash/wax treatments may cause wiper streaking.

Replace the wiper blades if they are worn or damaged. Damage can be caused by extreme dusty conditions, sand, salt, heat, sun, snow, and ice.

Weatherstrips

Apply weatherstrip lubricant on weatherstrips to make them last longer, seal better, and not stick or squeak. Lubricate weatherstrips at least once a year. Hot, dry climates may require more frequent application. Black marks from rubber material on painted surfaces can be removed by rubbing with a clean cloth.

Tyres

Use a stiff brush with tyre cleaner to clean the tyres.

Caution

Using petroleum-based tyre dressing products on the vehicle may damage the paint finish and/or tyres. When applying a tyre dressing, always wipe off any overspray from all painted surfaces on the vehicle.

Wheels and Wheel Trim

Use a soft, clean cloth with mild soap and water to clean the wheels. After rinsing thoroughly with clean water, dry with a soft, clean towel. A wax may then be applied.

Caution

Chrome wheels and chrome wheel trim may be damaged if the vehicle is not washed after driving on roads that have been sprayed with magnesium chloride or calcium chloride. These are used on roads for conditions such as dust and ice. Always wash the chrome with soap and water after exposure.

Caution

To avoid surface damage on wheels and wheel trims, do not use strong soaps, chemicals, abrasive polishes, cleaners or brushes. Use only GM approved cleaners. Do not drive the vehicle through an automatic car wash that uses silicon carbide tyre/wheel cleaning brushes. Damage could occur and the repairs would not be covered by the vehicle warranty.

Brake System

Visually inspect brake lines and hoses for proper hook-up, binding, leaks, cracks, chafing, etc. Inspect disc brake pads for wear and discs for surface condition. Inspect all other brake parts.

Steering, Suspension, and Chassis Components

Visually inspect steering, suspension, and chassis components for damaged, loose, or missing parts or signs of wear at least once a year.

Inspect power steering for proper electrical connections, binding, cracks, chafing, etc.

Visually check constant velocity joint boots and axle seals for leaks.

Body Component Lubrication

Lubricate all key lock cylinders, bonnet hinges, and tailgate hinges unless the components are plastic. Applying silicone grease on weatherstrips with a clean cloth will make them last longer, seal better, and not stick or squeak.

Underbody Maintenance

At least twice a year, spring and fall, use plain water to flush any corrosive materials from the underbody. Take care to thoroughly clean any areas where mud and other debris can collect.

Do not directly power wash the transfer case and/or front/rear axle output seals. High pressure water can overcome the seals and contaminate the fluid. Contaminated fluid will decrease the life of the transfer case and/or axles and should be replaced.

Sheet Metal Damage

If the vehicle is damaged and requires sheet metal repair or replacement, make sure the body repair shop applies anti-corrosion material to parts repaired or replaced to restore corrosion protection.

Original manufacturer replacement parts will provide the corrosion protection while maintaining the vehicle warranty.

Finish Damage

Quickly repair minor chips and scratches with touch-up materials available from your Cadillac Service Centre to avoid corrosion. Larger areas of finish damage can be corrected in your Cadillac Service Centre's body and paint shop.

Chemical Paint Spotting

Airborne pollutants can fall upon and attack painted vehicle surfaces causing blotchy, ring-shaped discolourations, and small, irregular dark spots etched into the paint surface. See "Finish Care" previously in this section.

Interior Care

To prevent dirt particle abrasions, regularly clean the vehicle's interior. Before using cleaners, read and follow all safety instructions on the label. While cleaning the interior, open the doors and windows to get proper ventilation. Newspapers or dark garments can transfer colour to the vehicle's interior.

Caution

Immediately remove cleaners, hand lotions, sunscreen, and insect repellent from all interior surfaces or permanent damage may result.

Caution

Use cleaners specifically designed for the surfaces being cleaned to prevent permanent damage to the vehicle. Apply all cleaners directly to a cleaning cloth. Do not spray cleaners on any switches or controls.

When using liquid soap cleaners, follow the directions on the specific cleaner or soap solution for dilution instructions.

Caution

To prevent damage:

- Never use a razor or any other sharp object to remove soil from any interior surface
- Never use a brush with stiff bristles.

(Continued)

Caution (Continued)

- Never rub any surface aggressively or with too much pressure.
- Do not get any exposed electrical components wet.
- Do not use laundry detergents or dishwashing soaps with degreasers. Do not use solutions that contain strong or caustic soap.
- Do not heavily saturate the upholstery when cleaning.
- Do not use solvents or cleaners containing solvents.
- Do not use disinfectant wipes that are scented or contain bleach. Do not use wipes or cleaners that show a colour transfer to the wipe or change the appearance of the interior surface when used.
- Do not use scented or gel-type hand sanitisers. If hand sanitiser comes into contact with interior surfaces of the vehicle, blot immediately and clean with a soft cloth dampened with a mild soap and water solution.

Interior Glass

To clean, use a microfibre cloth fabric dampened with water. Wipe droplets left behind with a clean dry cloth. If necessary, use a commercial glass cleaner after cleaning with plain water.

Caution

To prevent scratching, never use abrasive cleaners on automotive glass. Abrasive cleaners or aggressive cleaning may damage the rear window defogger.

Cleaning the windscreen with water during the first three to six months of ownership will reduce tendency to fog.

Speaker Covers

Vacuum around a speaker cover gently, so that the speaker will not be damaged. Clean spots with water and mild soap.

Coated Mouldings

Coated mouldings should be cleaned.

- When lightly soiled, wipe with a sponge or soft, lint-free cloth dampened with water.
- When heavily soiled, use warm soapy water.

Vinyl/Rubber

If equipped with vinyl floor and rubber floor mats, use a soft cloth and/or brush dampened with water to remove dust and loose dirt. For more thorough cleaning, use a mild soap and water solution.

Warning

Do not use cleaners that contain silicone, wax-based products, or cleaners that increase gloss on vinyl/rubber floor and mats. These cleaners can permanently change the appearance and feel of the vinyl/rubber and can make the floor slippery. Your foot could slip while operating the vehicle, and you could lose control, resulting in a collision. You or others could be injured.

Fabric/Carpet/Suede

Start by vacuuming the surface using a soft brush attachment. If a rotating vacuum brush attachment is being used, only use it on the floor carpet. Before cleaning, gently remove as much of the soil as possible:

- Gently blot liquids with a paper towel. Continue blotting until no more soil can be removed.

- For solid soil, remove as much as possible prior to vacuuming.

To clean:

1. Saturate a clean, lint-free colour-fast cloth with water. Microfiber cloth is recommended to prevent lint transfer to the fabric or carpet.
2. Remove excess moisture by gently wringing until water does not drip from the cleaning cloth.
3. Start on the outside edge of the soil and gently rub toward the centre. Fold the cleaning cloth to a clean area frequently to prevent forcing the soil into the fabric.
4. Continue gently rubbing the soiled area until there is no longer any colour transfer from the soil to the cleaning cloth.
5. If the soil is not completely removed, use a mild soap solution followed only by plain water.

If the soil is not completely removed, it may be necessary to use a commercial upholstery cleaner or spot lifter. Test a small hidden area for colourfastness before using a

commercial upholstery cleaner or spot lifter. If ring formation occurs, clean the entire fabric or carpet.

After cleaning, use a paper towel to blot excess moisture.

Cleaning High Gloss Surfaces and Vehicle Status and Radio Displays

Use a microfibre cloth on high gloss surfaces or vehicle displays. First, use a soft bristle brush to remove dirt that can scratch the surface. Then gently clean by rubbing with a microfibre cloth. Never use window cleaners or solvents. Periodically hand wash the microfibre cloth separately, using mild soap. Do not use bleach or fabric softener. Rinse thoroughly and air dry before next use.

Caution

Do not attach a device with a suction cup to the display. This may cause damage and would not be covered by the vehicle warranty.

Instrument Panel, Leather, Vinyl, Other Plastic Surfaces, Low Gloss Paint Surfaces, and Natural Open Pore Wood Surfaces

Use a soft bristle brush to remove dust from knobs and crevices on the instrument cluster. Use a soft microfiber cloth dampened with water to remove dust and loose dirt. For a more thorough cleaning, use a soft microfibre cloth dampened with a mild soap and water solution.

Caution

Soaking or saturating leather, especially perforated leather, as well as other interior surfaces, may cause permanent damage. Wipe excess moisture from these surfaces after cleaning and allow them to dry naturally. Never use heat, steam, or spot removers. Do not use liquids that contain alcohol or solvents on leather seats. Do not use cleaners that contain silicone or wax-based products. Cleaners containing these solvents can permanently change the appearance and feel of leather or soft trim, and are not recommended.

Do not use cleaners that increase gloss, especially on the instrument panel. Reflected glare can decrease visibility through the windshield under certain conditions.

Caution

Use of air fresheners may cause permanent damage to plastics and painted surfaces. If an air freshener comes in contact with any plastic or painted surface in the vehicle, blot immediately and clean with a soft cloth dampened with a mild soap solution. Damage caused by air fresheners would not be covered by the vehicle warranty.

Cargo Cover and Convenience Net

If equipped, wash with warm water and mild detergent. Do not use chlorine bleach. Rinse with cold water, and then dry completely.

Care of Seat Belts

Keep belts clean and dry.

⚠ Warning

Do not bleach or dye seat belt webbing. It may severely weaken the webbing. In a crash, they might not be able to provide adequate protection. Clean and rinse seat belt webbing only with mild soap and lukewarm water. Allow the webbing to dry.

Floor Mats**⚠ Warning**

If a floor mat is the wrong size or is not properly installed, it can interfere with the pedals. Interference with the pedals can cause unintended acceleration and/or increased stopping distance which can cause a crash and injury. Make sure the floor mat does not interfere with the pedals.

Use the following guidelines for proper floor mat use:

- The original equipment floor mats are designed for your vehicle. If the floor mats need to be replaced, it is recommended that GM-certified floor

mats are purchased. Non-GM floor mats may not fit properly and may interfere with the pedals. Always check that the floor mats do not interfere with the pedals.

- Do not use a floor mat if the vehicle is not equipped with a floor mat retainer on the driver side floor.
- Use the floor mat with the correct side up. Do not turn it over.
- Do not place anything on top of the driver side floor mat.
- Use only a single floor mat on the driver side.
- Do not place one floor mat on top of another.

Removing and Replacing the Floor Mats

The driver side floor mat is held in place by two button-type retainers.

The passenger side floor mat is held in place by two button-type retainers.

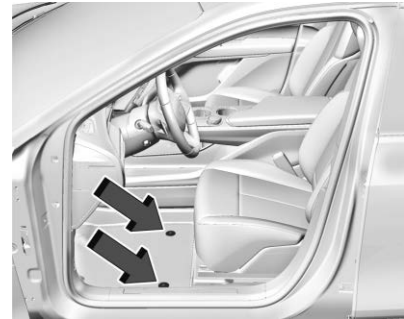

1. Pull up on the rear of the floor mat to unlock each retainer and remove.
2. Reinstall by lining up the floor mat retainer openings over the carpet retainers and snapping into position.
3. Make sure the floor mat is properly secured in place. Verify the floor mat does not interfere with the pedals.

Cleaning Rubber Floor Mats (All-Weather Mats and Floor Liners)

See “Vinyl/Rubber” under *Interior Care*
 ⇨ 284 for important cleaning information.

Service and Maintenance

General Information

General Information 288

Maintenance Schedule

Maintenance Schedule 289

Multi-Point Vehicle Inspection (MPVI)

Multi-Point Vehicle
Inspection (MPVI) 289

Owner Checks and Services

Owner Checks and Services 290

Recommended Fluids, Lubricants, and Parts

Recommended Fluids and Lubricants ... 291
Maintenance Replacement Parts 292

Maintenance Records

Maintenance Records 293

General Information

Your vehicle is an important investment. This section describes the required maintenance for the vehicle. Follow this schedule to help protect against major repair expenses resulting from neglect or inadequate maintenance. It may also help to maintain the value of the vehicle if it is sold. It is the responsibility of the owner to have all required maintenance performed.

Your Cadillac Service Centre has trained technicians who can perform required maintenance using genuine replacement parts. They have up-to-date tools and equipment for fast and accurate diagnostics. Many Cadillac Service Centres have extended evening and Saturday hours, courtesy transportation, and online scheduling to assist with service needs.

Your Cadillac Service Centre recognises the importance of providing competitively priced maintenance and repair services. With trained technicians, the Cadillac Service Centre is the place for routine maintenance such as tyre rotations and additional maintenance items like tyres, brakes, batteries, and wiper blades.

Caution

Damage caused by improper maintenance can lead to costly repairs and may not be covered by the vehicle warranty. Maintenance intervals, checks, inspections, recommended fluids, and lubricants are important to keep the vehicle in good working condition.

Do not have chemical flushes that are not approved by GM performed on the vehicle. The use of flushes, solvents, cleaners, or lubricants that are not approved by GM could damage the vehicle, requiring expensive repairs that are not covered by the vehicle warranty.

Proper vehicle maintenance helps to keep the vehicle in good working condition.

The Additional Required Services are for vehicles that:

- Carry passengers and cargo within recommended limits on the Tyre and Loading Information label. See *Vehicle Load Limits* ⇨ 155.
- Are driven on reasonable road surfaces within legal driving limits.

 **Warning**

Performing maintenance work can be dangerous and can cause serious injury. Perform maintenance work only if the required information, proper tools, and equipment are available. If they are not, see your Cadillac Service Centre to have a trained technician do the work. See *Doing Your Own Service Work* ⇨ 242.

Maintenance Schedule

Perform Required Services Every 24 Months or 24,000 km (15,000 mi)

- Perform the Multi-Point Vehicle Inspection. See *Multi-Point Vehicle Inspection (MPVI)* ⇨ 289.
- Lubricate body components. See *Exterior Care* ⇨ 280.

Additional Required Services — Normal Service

Every 24 000 km (15,000 mi)

Replace the passenger compartment air filter. Or every 24 months, whichever comes first. More frequent passenger compartment air filter replacement may be needed if

driving in areas with heavy traffic, poor air quality, high dust levels, or environmental allergens. Passenger compartment air filter replacement may also be needed if there is reduced airflow, window misting, or odours. Your Cadillac Service Centre can help determine when to replace the filter.

Every 144 000 km (90,000 mi)

Replace the bonnet and/or body lift support gas struts. Or every 10 years, whichever comes first. See *Gas Strut(s)* ⇨ 252.

Every 240 000 km (150,000 mi)

Drain and fill the coolant circuits. Or every four years, whichever comes first. See *Cooling System* ⇨ 246.

Severe Conditions Requiring More Frequent Maintenance

- Mainly driven in heavy city traffic in hot weather.
- Mainly driven in hilly or mountainous terrain.
- Frequently towing a trailer.
- Used for high speed or competitive driving.
- Used for taxi, police, or delivery service.

Additional Required Services — Severe Service

Every 72 000 km (45,000 mi)

- Change electric drive unit fluid. See *Recommended Fluids and Lubricants* ⇨ 291.

Owner Checks and Services

Every Four Years

Replace the brake fluid every four years and have the brake fluid checked for moisture every two years or 48,000 km (30,000 mi), whichever comes first. See *Brake Fluid* ⇨ 248.

Every Seven Years

Replace the air conditioning desiccant every seven years. This service helps the longevity and efficient operation of the air conditioning system. This service can be complex. See your Cadillac Service Centre.

Multi-Point Vehicle Inspection (MPVI)

A Multi Point Vehicle Inspection (MPVI) completed by a trained technician is a maintenance assessment of your vehicle. The benefit of the MPVI is to identify

service items that require immediate attention and those that may require attention in the future.

The technician will perform the following checks on your vehicle. You can obtain a copy of the appropriate MPVI checklist on your country's GM Certified Service website. For a complete list of checks, inspections, and services, see your Cadillac Service Centre.

Some items may not apply to your vehicle and/or region.

Diagnostics

- Service history/recall check

Exterior Lights

- Visual inspection

Windscreen and Wipers

- Visual inspection

12 Volt Battery

- Battery visual inspection
- Battery test results
- Battery cables and connections

Systems, Fluids, and Visible Leak Inspection

- Electric Drive Unit

- Drive axle
- Transfer case
- Power electronics cooling system
- Windscreen washer fluid

Tyre Inspection

- Tyre pressure, tread depth, and wear
- Rotation, if applicable
- Alignment check, optional
- Reset tyre pressure monitor
- Check the tyre sealant expiration date, if equipped
- Check spare tyre, if equipped

Brakes

- Check brake system

Visible and Functional Inspections

- Seat belt components
- Accelerator pedal
- Passenger compartment air filter, if equipped
- Hoses
- Shocks and struts
- Steering components
- Axle boots or driveshaft and u-joints
- Compartment lift struts, if equipped

- Floor mats secured, no interference with pedals
- Horn
- Starter switch

Lubricate

- Chassis components

Owner Checks and Services

- At least twice a year, have underbody flushing service performed. See "Underbody Maintenance" in *Exterior Care* ⇨ 280.

Recommended Fluids, Lubricants, and Parts

Recommended Fluids and Lubricants

Fluids and lubricants identified below by name or specification, including fluids or lubricants not listed here, can be obtained from your Cadillac Service Centre.

Usage	Fluid/Lubricant
Electric Drive Unit	DEXRON ULV Automatic Transmission Fluid.
Hydraulic Brake System	GM approved DOT 4 Hydraulic Brake Fluid.
Key Lock Cylinders, Bonnet and Tailgate Hinges	Multi-Purpose Lubricant, Superlube. See your Cadillac Service Centre.
Vehicle Coolant Circuits	Use only ACDelco Premix (50/50 mixture of de-ionised water and DEX-COOL Coolant). See your Cadillac Service Centre.
Windscreen Washer	Automotive windscreen washer fluid that meets regional freeze protection requirements.

Maintenance Replacement Parts

Replacement parts identified below by name, part number, or specification can be obtained from your dealer.

Part	GM Part Number	ACDelco Part Number
Passenger Compartment Air Filter	13540923	CF206C
Wiper Blades		
Driver Side – 66 cm (26 in)	84732989	-
Passenger Side – 46 cm (18 in)	84732990	-

Technical Data

Vehicle Identification

Vehicle Identification Number (VIN) ... 294

Service Parts Identification 294

Vehicle Data

Capacities and Specifications 295

Vehicle Identification

Vehicle Identification Number (VIN)



This legal identifier is in the front corner of the instrument panel, on the driver side of the vehicle. It can be seen through the windscreen from outside. The Vehicle Identification Number (VIN) also appears on the Vehicle Certification label and certificates of title and registration.

Service Parts Identification

There may be a large barcode on the certification label on the centre pillar that you can scan for the following information:

- Vehicle Identification Number (VIN)
- Model designation
- Paint information
- Production options

If there is not a large barcode on this label, then you will find this same information on a label inside the boot.

Vehicle Data

Capacities and Specifications

The following approximate capacities are given in metric and English conversions.

Refer to *Recommended Fluids and Lubricants* ⇨ 291 for more information.

Application	Capacities	
	Metric	English
Air Conditioning Refrigerant	For the air conditioning system refrigerant charge type and amount, see the refrigerant label under the bonnet. See your Cadillac Service Centre for more information.	
Total Cooling System*	See your Cadillac Service Centre.	
Wheel Nut Torque	190 N•m	140 lb ft
*The refilling or adding coolant procedures can be complex. See your Cadillac Service Centre.		

Customer Information

Customer Information

Declaration of Conformity 296

Vehicle Data Recording and Privacy

Vehicle Data Recording and Privacy ... 303

Cybersecurity 304

Customer Information

Declaration of Conformity

Radio Frequency Devices

China

- Shall not change transmission frequency, increase transmission power (including additional RF power amplifier), and shall not connect external aerial or change the transmitting aerial.
- When used, it shall not generate harmful interference to various legitimate radio communication services. Once interference is found, it shall be stopped immediately, and measures shall be taken to eliminate interference before it can continue to be used.
- When using micropower radio equipment, interference from various radio services or radiation interference from industrial, scientific and medical applications must be tolerated.
- Shall not be used near aircraft and airports.

Nigeria

Connection and use of this communications equipment is permitted by the Nigerian Communications Commission.

Battery Radio-Frequency Module — Single

Austria

DEKRA Identification No. 73704RNB.002

China

Model: VPNAMU-12A651-AG

Certification applied for

Israel

Wireless approval signed by the Ministry of Communication no. 55-14363

Japan

The Battery Radio Frequency Module (BRFM) is compliant with the Radio Act certification (grant ID 023-220001).

This device should not be modified (otherwise the granted designation number will become invalid).

Jordan

Approval No. TRC/34/10926/2022

Oman

OMAN TRA
TA-R/14679/22
D172338

South Korea

To be granted

United Arab Emirates (UAE)

TRA
REGISTERED No:
ER15600/22
DEALER No:
DA0089862/12

Body Control Module**China**

Model: B1NA5

Transmitting Power: 125 kHz

Maximum Output Power: 1.58 mW (EIRP),
2.01 dBm (EIRP)

Israel

Trademark: DENSO

Year of Manufacture: See product

Product: Passive Entry Passive Start system
(LF Transmitter and LF Transceiver)

Model: B1NA5

Manufacturing Country: USA

Jordan

Ref No. T/4/11/11/2029

Oman

OMAN - TRA
R/11113/21
D100428

OMAN TRA
TA-R/6040/18
D080134

South Korea

Model B1NA0

Registration No. R-R-DKR-B1NA0

United Arab Emirates (UAE)

TRA
REGISTERED No:
ER96377/21
DEALER No:
DA00290/21

Cell Monitoring Unit (SLA8)**Israel**

Wireless approval signed by the Ministry of
Communication no. 65-66575

Japan

The Cell Monitoring Unit is compliant with
the Radio Act certification (grant ID
023-220002).

This device should not be modified
(otherwise the granted designation number
will become invalid).

Jordan

Approval No. TRC/34/10865/2022

Oman

OMAN TRA
TA-R/14681/22
D172338

United Arab Emirates (UAE)

TRA
REGISTERED No:
ER15599/22
DEALER No:
DA0089862/12

Radar Hands-Free

Israel

MOC No. 55-12957

Jordan

TRC No. TRC/32/9519/2022

Oman

OMAN TRA
TA-R/13032/22
D100428

United Arab Emirates (UAE)

TRA
REGISTERED No:
ER04644/22
DEALER No:
not available

Radar Long Range (ARSS40)

United Arab Emirates (UAE)

TRA
REGISTERED No:
ER68006/18
DEALER No:
DA40068/15

Radar Long Range (LRR120)

Oman

OMAN TRA
TA-R/7713/19
D172338

South Korea

Certification No. R-C-1VN-77V12FLR

United Arab Emirates (UAE)

Authorisation No. ER72325/19

Radar Short Range (SBZA)

China

Automotive driver assistant radar system
model Hella RS53A

Micropower short range radio transmission
device category H

Frequency Range: 76 – 77 GHz

Emission Power: 0.4365W

Aerial: Integrated microstrip patch array
aerial

User Controls: None

Jordan

TRC No. TRC/31/10345/2022

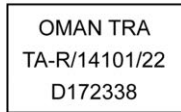
Oman**United Arab Emirates (UAE)**

Model: RS5.3A

Product Type: Advanced Driver Assistance System

**Remote Function Receiver (RFR)****Oman****United Arab Emirates (UAE)****Remote Key (B1)****Israel**

MOC No. 55-00212

Jordan

TRC No. TRC/SS/2018/373

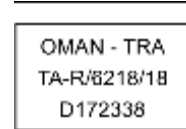
Oman**United Arab Emirates (UAE)****RFID – Microwave Window RFID Vehicle Registration Device Positioning****China**

Microwave window: The entire windscreen allows microwave transmission. Position the transponder horizontally on the passenger side of windscreen next to or behind the inside rear-view mirror. The distance from the top edge of the electronic identification device to the top edge of windscreen shall be no less than 4 cm. The position of the transponder should not obstruct the driver's forward view.

300 Customer Information

Tyre Pressure Sensor (Delta 314.9 Mhz) (G6GB3)

Japan

Tyre Pressure Sensors are compliant with the Radio Act certification (grant ID 201-190091).

This device should not be modified (otherwise the granted designation number will become invalid).

Tyre Pressure Sensor (Faraday/Delta 433 Mhz) (G6GB4)

Jordan

TRC No. T/4/11/11/3816

Oman

OMAN TRA
TA-R/7742/19
D090258

United Arab Emirates (UAE)

TRA
REGISTERED No:
ER70116/19
DEALER No:
DA0047074/10

Universal Garage Door Opener (UGDO) (2023–25)

China

Model: SAHL5K

Frequency Range: 314 – 316 MHz, 433 – 434.79 MHz

Transmitting Power: <10 mW (e.r.p)

Occupied Bandwidth: 400 kHz

Morocco

Approved by Morocco

Approval number: MR 25908 ANRT 2020

Approval date: 07/10/2020

United Arab Emirates (UAE)

TRA
REGISTERED No:
ER46032/16
DEALER No:
DA35176/14

Universal Garage Door Opener (UGDO with LIN)

Jordan

Model LMHL5A

TRC No. TRC/34/10006/2022

United Arab Emirates (UAE)

TRA
REGISTERED No:
ER46032/16
DEALER No:
DA35176/14

2014/53/EU Radio Equipment Directive (RED) Declaration of Conformity

This vehicle has systems that transmit and/ or receive radio waves subject to 2014/53/ EU. The manufacturers of the systems listed below declare conformity with Directive 2014/53/EU. The full text of the EU

declaration of conformity for each system is available at the following Internet address: www.cadillaceurope.com.

This vehicle has systems that transmit and/or receive radio waves subject to Radio Equipment Regulations of the United Kingdom. The manufacturers of the systems listed below declare conformity with Radio Equipment Regulations of the United Kingdom. The full text of the United Kingdom declaration of conformity for each system is available at the following Internet address: www.cadillaceurope.com.



EU Importer

GM Mobility Europe GmbH
Bethmannstraße 50-54 Ort
60311 Frankfurt am Main
Hessen
Germany

UK Importer

GM Specialty Vehicles UK Limited
100 New Bridge Street
London, EC4V 6JA, UK

Battery Radio Frequency Module – Single (BRFMS)

Visteon Corporation
One Village Centre Drive
Visteon Village 25.2.025
Van Buren Township, MI 48111-5711
USA

Model No. VPNAMU-12A651-AG
Operation frequency: 2.4-2.5 GHz
Maximum output power: <10 dBm

Body Control Module (BCM)

DENSO INTERNATIONAL AMERICA INC.
24777 DENSO Drive
Southfield, MI 48033 – USA
Model: BINA5
Operation frequency: 125kHz
Maximum output power (ERP): 0.97 mW

Cell Monitoring Unit

Visteon Corporation
One Village Centre Drive
Van Buren Township, MI 48111-5711
USA

Brand Name: Visteon

Model Name: SLA8

Radar Hands Free (MY23)

Acconeer AB
Lund, 22370
Sweden

Frequency Range (Mhz): 57000.0 – 64000.0

Output Watts (EIRP): 0.0019

Radar Hands Free (MY24)

ALPS ALPINE CO., LTD.
6–3–36, Furukawanakazato
Osaka City, Miyagi-pref, Japan
Product Description: Kick Sensor
Model No. B2111

302 Customer Information

Radar Long Range (LRR120)

Veoneer US, Inc.

26545 American Drive

Southfield, MI 48034

Frequency Range (MHz): 76000.0 – 77000.0

Output Watts: 0.153

Radar Short Range (RS5.3A)

Hella GmbH & Co. KGaA

Rixbecker Straße 75

59552 Lippstadt, Germany

Frequency: 76-77 GHz

Transmission Power: 20 dBm (average) EIRP

Remote Function Receiver (RFR) Huf

Huf Hülsbeck and Fürst and Co. KG

Address: Steeger Str. 17

42251 Velbert Germany

Operation frequency: 433.92MHz

Remote Key (B1)

Huf Hülsbeck & Fürst GmbH & Co. KG

Steeger Str. 17, 42551 Velbert, Germany

Telematics Module

Continental Automotive Systems Inc.

21440 West Lake Cook Road

Deer Park, IL 60010

Tyre Pressure Sensor Transmitter (Delta 314.9 Mhz) (G6GB3)

Schrader Electronics Ltd.

11 Technology Park

Belfast Road

Antrim Bt41 1QS

Northern Ireland

United Kingdom

Operating frequency: 433.92 MHz

Maximum transmit power: 10 dBm

Tyre Pressure Sensor Transmitter (Faraday/ Delta 433 Mhz) (G6GB4)

Schrader Electronics Ltd.

11 Technology Park

Belfast Road

Antrim Bt41 1QS

Northern Ireland

United Kingdom

Operating frequency: 433.92 MHz

Maximum transmit power: 10 dBm

Universal Garage Door Opener Transmitter (UGDO 2023-25)

Genex Corporation

600 N. Centennial

Zeeland, MI 49464

USA

Virtual Cockpit Unit (VCU) - Low/Mid/High

Robert Bosch GmbH

Robert-Bosch-Strasse 200

Hildesheim, 31139

Germany

Frequency Range (MHz): 88.0 – 108.0

Virtual Key Backup Module (VKBM)

Vitesco Technologies

PTC-TES-CMS

2400 Executive Hills Blvd

Auburn Hills, MI 48326

Virtual Key Module (VKM)

Perfectly Keyless System for Automotive

Robert Bosch LLC

15000 Haggerty Rd.

Plymouth, MI 48170

Frequency Range (MHz): 2402.0 – 2480.0

Output Watts: 0.00158

Virtual Key Sensor (VKS)

Perfectly Keyless System for Automotive

Robert Bosch Corporation

15000 Haggerty Rd.

Plymouth, MI 48170

Wireless Charging Module

LG Electronics European Shared

Service Centre B.V. Krijgsman 1

1186 DM Amstelveen

The Netherlands

Operating frequency: 145 kHz

Maximum transmit power: 3 amp (15w)

Wireless Garage Door Opener (UGDO with LIN)

Gentex Corporation

600 N. Centennial

Zeeland, MI 49464

USA

Operating frequency: 433.05 MHz -
434.79 MHz

Maximum transmit power: 0.138 mW E.R.P.

Vehicle Data Recording and Privacy**Event Data Recorders****Data Storage Modules in the Vehicle**

A large number of electronic components of your vehicle contain data storage modules temporarily or permanently storing technical data about the condition of the vehicle, events, and errors. In general, this technical information documents the condition of parts, modules, systems, or the environment:

- Operating conditions of system components (e.g., filling levels).

- Status messages of the vehicle and its single components (e.g., number of wheel revolutions/rotational speed, deceleration, lateral acceleration).
- Dysfunctions and defects in important system components.
- Vehicle reactions in particular driving situations (e.g., inflation of an airbag, activation of the stability regulation system).
- Environmental concerns (e.g., temperature).

This data is exclusively technical and helps identify and correct errors as well as optimise vehicle functions.

Motion profiles indicating travelled routes cannot be created with this data.

If services are used (e.g., repair works, service processes, warranty cases, quality assurance), employees of the service network (manufacturer included) are able to read out this technical information from the event and error data storage modules applying special diagnostic devices. If required, you will receive further information at these Cadillac Service Centres.

After an error has been corrected, the data is deleted from the error storage module or constantly overwritten.

When using the vehicle, situations may occur in which these technical data related to other information (crash report, damage to the vehicle, witness statements, etc.) may be associated with a specific person — possibly, with the assistance of an expert.

In an emergency, your vehicle location and other data may be transmitted to emergency services in accordance with Directive (EU) 2015/758. See *eCall Overview* ⇨ 305.

Cybersecurity

GM collects information about the use of your vehicle including operational and safety related information. We collect this information to provide, evaluate, improve, and troubleshoot our products and services and to develop new products and services. The protection of vehicle electronics systems and customer data from unauthorised outside electronic access or control is important to GM. GM maintains appropriate security standards, practices, guidelines and controls aimed at defending the vehicle and the vehicle service ecosystem against

unauthorised electronic access, detecting possible malicious activity in related networks, and responding to suspected cybersecurity incidents in a timely, coordinated and effective manner. Security incidents could impact your safety or compromise your private data. To minimise security risks, please do not connect your vehicle electronic systems to unauthorised devices or connect your vehicle to any unknown or untrusted networks (such as Bluetooth, Wi-Fi or similar technology). In the event you suspect any security incident impacting your data or the safe operation of your vehicle, please stop operating your vehicle and contact your Cadillac Service Centre.

eCall

eCall Overview

eCall Overview 305

eCall Overview

This vehicle is equipped with a 112 based eCall system that is free of charge.

In the event of a crash, an eCall-equipped vehicle may automatically call the nearest 112 emergency centre. If built-in sensors detect a crash, an emergency call is placed automatically. An advisor will determine whether help is needed. The exact location of the crash site is sent to the emergency centre even if the occupants of the vehicle are unable to communicate with emergency personnel.



The eCall system can also be activated manually. Press **SOS** on the overhead console to contact the nearest 112 emergency centre. Press **☒** within two seconds to cancel the manually activated eCall.

A problem with the system may be indicated by the following:

- Red light near the phone button displays
- Light near the phone button does not display with vehicle on
- Driver Information Centre message may appear

See your Cadillac Service Centre for service.

When the system is active, the green light near the phone button is illuminated.

Usage of personal data is strictly limited to the purpose of forwarding the emergency call to the emergency number 112.

The eCall system may collect and process the following data:

- Vehicle Identification Number
- Vehicle type, such as passenger vehicle or light commercial vehicle
- Vehicle propulsion storage type, such as petrol, diesel, CNG, LPG, electric, or hydrogen
- Last three vehicle locations and direction of travel
- Automatic activation log file for the system and its time stamp

Data collected by the eCall system is shared only with the 112 emergency centre when a connection is made.

Data collected by the system is:

- Temporarily stored in the system memory, but it is not available outside of the system before an eCall is triggered.
- Not traceable and not subject to constant tracking during normal system operation.
- Stored in the system's memory but is automatically and continuously deleted.

Vehicle location data is continuously overwritten and limited to the last three locations for normal operation of the system.

The system activity log is kept for the duration of the emergency call, or a maximum of 13 hours after the call was initiated.

The data subject, or vehicle owner, has the right to access the data and as appropriate, to request the rectification, erasure or blocking of personal data when processing of the data does not comply with local regulations. Any third parties who received the data must be notified of any rectification, erasure, or blocking done to

comply with local regulations unless it proves impossible or involves a disproportionate effort.

The data subject, or vehicle owner, has the right to complain to the competent data protection authority if he or she feels that his or her rights have been infringed as a result of the processing of his or her personal data.

Index

A	
Accessories and Modifications	242
Accessory Power	161
Adaptive	
Cruise Control	173
Forward Lighting (AFL)	115
Forward Lighting (AFL) Light	98
Add-On Electrical Equipment	240
Adjustments	
Lumbar, Front Seats	37
Advanced	
Driver Assistance Systems	182
Agreements	
Trademarks and License	138
Air	
Conditioning	140, 144
Filter, Passenger Compartment	145
Vents	145
Airbag System	50
Check	58
How Does an Airbag Restrain?	54
What Makes an Airbag Inflate?	53
What Will You See after an Airbag Inflates?	54
When Should an Airbag Inflate?	53
Where Are the Airbags?	52
Airbags	
Adding Equipment to the Vehicle	58
Airbags (cont'd)	
Light On-Off	92
On-Off Light	92
On-Off Switch	55
Readiness Light	91
Replacing System Parts after a Crash	58
Servicing Airbag-Equipped Vehicles	57
Alarm	
Vehicle Security	23
Alert	
Blind Zone Steering Assist (BZSA)	206
Lane Change (LCA)	204
Rear Cross Traffic	193
Rear Pedestrian	192
Side Blind Zone (SBZA)	204
All-Wheel Drive	166
Light	95
AM-FM Radio	126
Antenna	
Multi-band	130
Anti-theft	
Locking System	25
Antilock Brake System (ABS)	166
Warning Light	94
Appearance Care	
Exterior	280
Interior	284

Apple CarPlay and Android Auto	135	Automatic (cont'd)		Brakes (cont'd)	
Assistance Systems		Emergency Braking (AEB) Disabled		Brake Assist	168
Advanced	182	Light	95	Electric Brake Boost	166
Automatic Emergency		Headlamp System	115	Electric Parking Brake	167
Braking (AEB)	198	Parking Assist (APA)	188	Regenerative Braking	169
Automatic Parking Assist (APA)	188	Vehicle Hold Light	95	Braking	151
Blind Zone Alert (SBZA)	204	Automatic Vehicle Hold (AVH)	168	Automatic Emergency (AEB)	198
Blind Zone Steering (BZSA)	206	Avoiding Untrusted Media Devices	130	Front Pedestrian (FPB) System	202
Driver Attention	208	B		Reverse Automatic	191
Driving	194	Battery	249	Bulb Replacement	
Forward Collision Alert (FCA)		Charging Electrical Requirements	225	Headlamp Aiming	253
System	196	Exterior Lighting Battery Saver	120	Buying New Tyres	272
Front Pedestrian Braking (FPB)	202	Fault Light	93	C	
Lane Change Alert (LCA)	204	Gauge	89	Calibration	
Lane Keep Assist (LKA)	210	Jump Starting	275	Compass	82
Parking	187	Load Management	120	Camera	
Parking and Reversing	184	Power Protection	120	Rear Vision (RVC)	184
Rear Cross Traffic Alert (RCTA)	193	Blade Replacement, Wiper	252	Capacities and Specifications	295
Rear Pedestrian Alert	192	Bluetooth		Car Wash Mode	162
Rear Vision Camera (RVC)	184	Audio	130	Carbon Monoxide	
Reverse Automatic Braking (RAB)	191	Overview	131	Tailgate	17
Speed Limiter	194	Bonnet	243	Winter Driving	154
Surround Vision System	185	Brake		Cargo	
Traffic Sign	206	Fluid	248	Cover	75
Audio		System Warning Light	93	Management System	77
Bluetooth	130	Brakes	247	Tie-Downs	77
Automatic		Antilock	166	Caution, Danger, and Warning	1
Door Locks	15				

Centre Console			
Storage	75		
Charge			
Cable	218		
Charging	100		
Delay Override	216		
Electricity Supply Interruption	225		
Plug-In	212		
Status Feedback	217		
System Light	92		
Wireless	84		
Charging cable Connected Light	93		
Child Restraints			
Infants and Young Children	60		
ISOFIX	70		
Older Children	59		
Securing	72		
Systems	61		
Child Safety Locks	15		
Circuit Breakers	255		
Cleaning			
Exterior Care	280		
Interior Care	284		
Climate Control Systems			
Dual Automatic	140		
Rear	144		
Clock	82		
Cluster, Instrument	87		
Collision Alert			
Forward (FCA) System	196		
Compartment			
Underhood	245		
Compartments			
Storage	74		
Compass	82		
Conformity			
Declaration of	296		
Control			
Traction and Electronic Stability	170		
Control of a Vehicle	151		
Controls			
Steering Wheel	124		
Convex Mirrors	26		
Cooling	140, 144		
Cooling System	246		
Cornering Lights	118		
Cover			
Cargo	75		
Cruise Control			
Adaptive	173		
Light	99		
Cupholders	75		
Cybersecurity	304		
D			
Danger, Warning, and Caution	1		
Dashboard	4		
Daytime Running Lamps (DRL)	114		
Declaration of Conformity			
Certification Information	296		
Defensive Driving	151		
Delayed Charging Override	216		
Delayed Locking	14		
Digital			
Audio Broadcast (DAB) Radio	128		
Key	15		
Disabled Vehicle			
Transporting	278		
Distracted			
Driving	150		
Distracted Driving	150		
Dome Lamps	119		
Door			
Ajar Light	100		
Delayed Locking	14		
Locks	13		
Power Locks	14		
Drive Systems			
All-Wheel Drive	166		
Drive Unit			
Electric	162		

- Driver
Assistance Systems, Advanced 182
Attention Assist 208
Attention Assist Light 99
Information Centre (DIC) 105
Mode Control 171
Mode Control Light 97
- Driving
Assistance Systems 194
Characteristics and Towing Tips 225
Defensive 151
Hill and Mountain Roads 154
If the Vehicle is Stuck 155
Loss of Control 152
Off-Road Recovery 152
One-Pedal 165
Vehicle Load Limits 155
Wet Roads 153
Winter 154
- Driving for Better Energy Efficiency 149
- Dual
Automatic Climate Control System 140
- E**
eCall
Overview 305
- Electric
Brake Boost 166
- Electric (cont'd)
Drive Unit 162
Parking Brake 167
Parking Brake Light 94
- Electrical
Equipment, Add-On 240
Requirements for Battery Charging 225
System Overload 254
- Electrical System
Fuses and Circuit Breakers 255
Instrument Panel Fuse Block 260
- Electronic Stability Control (ESC) Off
Light 97
- Energy Efficiency
Driving 149
- Engine
Cooling System 246
- Entry Lighting 119
- Equipment, Towing 231
- Exit Lighting 120
- Extended Parking 162
- Exterior
Light Controls 113
Lighting Battery Saver 120
Lights Off Reminder 114
- F**
Flash-to-Pass 114
Flat Tyre 275
Floor Mats 287
Fluid
Brakes 248
Washer 247
- Fog Lamp Light
Rear 99
- Fog Lamps
Rear 118
- Folding Mirrors 27
- Front
Heated and Ventilated Seats 40
- Fuses
Fuses and Circuit Breakers 255
Instrument Panel Fuse Block 260
Underhood Compartment 256
- G**
Gas Strut(s) 252
- Gauges
Battery 89
Mileometer 89
Power Indicator 90
Speedometer 89
Trip Odometer 89
Warning Lights and Indicators 86

- | | | |
|---------------------------------|--|----------|
| General Information | High-Speed Operation | 266 |
| Service and Maintenance | Hill and Mountain Roads | 154 |
| Towing | Hill Start Assist (HSA) | 168 |
| Vehicle Care | Horn | 81 |
| Glove Box | How to Wear Seat Belts Properly | 45 |
| | HVAC | 140, 144 |
| H | I | |
| Hazard Lights | Indicator | |
| Head Restraints | Pedestrian Ahead | 96 |
| Head-Up Display (HUD) | Speed Limiter | 90 |
| Headlamps | Vehicle Ahead | 96 |
| Adaptive Forward Lighting (AFL) | Indicators | |
| Aiming | Warning Lights and Gauges | 86 |
| Automatic | Infants and Young Children, Restraints | 60 |
| Daytime Running Lamps (DRL) | Infotainment | |
| Flash-to-Pass | Using the System | 124 |
| Lamps On Reminder | Inspection | |
| Levelling Control | Multi-Point Vehicle | 289 |
| Main-Beam On Light | Instrument Cluster | 87 |
| Main/Dipped Beam Changer | Instrument Panel | |
| Heated | Storage Area | 74 |
| Mirrors | Instrument Panel Overview | 4 |
| Rear Seats | Interior Rearview Mirrors | 28 |
| Steering Wheel | Interruption of Charging by the | |
| Ventilated Front Seats | Electricity Supplier | 225 |
| Heating | Introduction | 1, 122 |
| High Voltage Battery Gauge | ISOFIX Child Restraint Systems | 70 |
| High Voltage Devices and Wiring | | |
| | J | |
| | Jump | |
| | Starting | 275 |
| | K | |
| | Keys | 6 |
| | Digital | 15 |
| | Remote | 7 |
| | Remote Operation | 7 |
| | L | |
| | Lamps | |
| | Cornering | 118 |
| | Daytime Running (DRL) | 114 |
| | Dome | 119 |
| | Exterior Controls | 113 |
| | Exterior Lamps Off Reminder | 114 |
| | Exterior Lighting Battery Saver | 120 |
| | Flash-to-Pass | 114 |
| | Main/Dipped Beam Changer | 114 |
| | On Reminder | 99 |
| | Reading | 119 |
| | Rear Fog | 118 |
| | Lane | |
| | Keep Assist Light | 95 |
| | Lap-Shoulder Belt | 47 |
| | LED Lighting | 253 |
| | Levelling Control | |
| | Headlamp | 117 |

Lighting			
Adaptive Forward	115	Lights (cont'd)	
Entry	119	Lane Keep Assist	95
Exit	120	Low State of Charge	92
Illumination Control	118	Main-Beam On	98
LED	253	Rear Fog Lamp	99
Lights		Seat Belt Reminders	90
Adaptive Forward Lighting (AFL)		Security	98
Light	98	Service Electric Parking Brake	94
Airbag On-Off	92	Service Vehicle Soon	93
Airbag Readiness	91	Traction Control System	
All-Wheel-Drive	95	(TCS)/Electronic Stability Control	
Antilock Brake System (ABS)		Light	96
Warning	94	Traction Off	96
Automatic Emergency Braking (AEB)		Tyre Pressure	97
Disabled	95	Vehicle Ready	98
Automatic Vehicle Hold	95	Lights, Hazard	117
Battery Fault	93	Lock	
Brake System Warning	93	Steering Column	25
Charging cable Connected	93	Locking Systems, Anti-theft	25
Charging System	92	Locks	
Cruise Control Light	99	Automatic Door	15
Door Ajar	100	Delayed Locking	14
Driver Attention Assist	99	Door	13
Driver Mode Control	97	Lockout Protection	15
Electric Parking Brake	94	Power Door	14
Electronic Stability Control (ESC), Off ...	97	Safety	15
Gauges and Indicators	86	Loss of Control	152
		Low State of Charge Light	92
		Low-Profile Tyres	264
		Lumbar Adjustment	37
		Front Seats	37
		M	
		Main-Beam On Light	98
		Maintenance	
		Records	293
		Maintenance Schedule	289
		Recommended Fluids and	
		Lubricants	291
		Massage	
		Seats	37
		Media	
		Avoiding Untrusted Devices	130
		Memory Seats	38
		Messages	
		Propulsion Power	111
		Vehicle	110
		Vehicle Speed	112
		Mileometer	89
		Trip	89
		Mirrors	
		Automatic Dimming Rear View	28
		Convex	26
		Folding	27
		Heated	28
		Interior Rearview	28

Mirrors (cont'd)			
Manual Rearview	28		
Power	26		
Rear Camera	28		
Mode			
Car Wash	162		
Driver Control	171		
Monitor System, Tyre Pressure	267		
Multi-band Aerial	130		
Multi-Point Vehicle Inspection (MPVI)	289		
N			
New Vehicle Run-In	158		
O			
Off-Road			
Recovery	152		
Older Children, Restraints	59		
One-Pedal Driving	165		
Outlets			
Power	82		
Overview	123		
Instrument Panel	4		
Owner Checks and Services	290		
P			
Park			
Assist	184, 187		
Shifting Into	161		
Park (cont'd)			
Shifting Out of	161		
Parking			
Brake and P (Park) Mechanism			
Check	251		
Extended	162		
Parking Assist			
Automatic	188		
Parking or Reversing			
Assistance Systems	184		
Passenger			
Compartment Air Filter	145		
Pedestrian Ahead Indicator	96		
Pedestrian Safety Signal	81		
Phone			
Apple CarPlay and Android Auto	135		
Bluetooth	131		
Plug-In Charging	212		
Port			
USB	130		
Power			
Button	159		
Door Locks	14		
Indicator Gauge	90		
Mirrors	26		
Outlets	82		
Protection, Battery	120		
Retained Accessory (RAP)	161		
Power (cont'd)			
Seat Adjustment	35		
Windows	31		
Pregnancy, Using Seat Belts	49		
Privacy			
Vehicle Data Recording	303		
Propulsion			
Power Messages	111		
R			
Radiator	246		
Radio			
AM-FM Radio	126		
Digital Audio Broadcast (DAB)	128		
Reception	129		
Reading Lamps	119		
Ready Indicator	98		
Rear			
Camera Mirror	28		
Climate Control System	144		
Fog Lamps	118		
Heated Seats	44		
Seats	41		
Rear View Mirrors	28		
Automatic Dimming	28		
Reclining Seat Backrests	36		
Recommended Fluids and Lubricants	291		

Records		S	
Maintenance	293	Safety	
Regenerative Braking	169	Locks	15
Remote		Pedestrian Signal	81
Key	7	Safety System Check	49
Key Operation	7	Seat Belts	44
Start	12	Care	49
Replacement Parts		How to Wear Seat Belts Properly	45
Airbags	58	Lap-Shoulder Belt	47
Maintenance	292	Reminders	90
Replacing		Replacing after a Crash	50
Airbag System	58	Use During Pregnancy	49
Seat Belt System Parts after a Crash	50	Seats	
Requirements		Head Restraints	34
Electrical Battery Charging	225	Heated and Ventilated, Front	40
Restraints		Heated, Rear	44
Where to Put	65	Lumbar Adjustment, Front	37
Retained Accessory Power (RAP)	161	Massage	37
Roads		Memory	38
Driving, Wet	153	Power Adjustment, Front	35
Roof		Rear	41
Rack System	77	Reclining Seat Backrests	36
Sunroof	32	Securing Child Restraints	72
Rotation, Tyres	271	Security	
Running-In, New Vehicle	158	Light	98
		Vehicle	23
		Vehicle Alarm	23
		Self-Sealing Tyres	264
		Service	147
		Accessories and Modifications	242
		Doing Your Own Work	242
		Electric Parking Brake Light	94
		Maintenance Records	293
		Maintenance, General Information	288
		Parts Identification	294
		Vehicle Soon Light	93
		Servicing the Airbag	57
		Settings	137
		Shifting	
		Into Park	161
		Out of Park	161
		Signals, Turn and Lane-Change	117
		Software Updates	126
		Specifications and Capacities	295
		Speed	
		Limiter	194
		Limiter Indicator	90
		Speedometer	89
		Start	
		Remote	12
		Start Assist, Hill	168
		Starting and Stopping the Vehicle	160
		Status	
		Charging Feedback	217
		Vehicle	106
		Steering	151

- | | | | | | |
|-------------------------|-----|--------------------------------------|-----|----------------------------------|----------|
| Steering (cont'd) | | System (cont'd) | | Triangle, Warning | 77 |
| Column Lock | 25 | Roof Rack | 77 | Trip Odometer | 89 |
| Heated Wheel | 80 | T | | Turn and Lane-Change Signals | 117 |
| Wheel Adjustment | 80 | Tailgate | 17 | Tyres | 263 |
| Wheel Controls | 124 | Theft-Deterrent Systems | 25 | Buying New Tyres | 272 |
| Storage | | Time | 82 | Different Size | 273 |
| Centre Console | 75 | Towing | | If a Tyre Goes Flat | 275 |
| Compartments | 74 | Driving Characteristics | 225 | Inspection | 270 |
| Cupholders | 75 | Equipment | 231 | Low-Profile | 264 |
| Glove Box | 74 | General Information | 225 | Pressure | 265, 266 |
| Instrument Panel Areas | 74 | Trailer | 228 | Pressure Light | 97 |
| Roof Rack System | 77 | Trailer Sway Control (TSC) | 239 | Pressure Monitor Operation | 268 |
| Storage Areas | | Traction | | Pressure Monitor System | 267 |
| Cargo Cover | 75 | Control System (TCS)/Electronic | | Rotation | 271 |
| Cargo Management System | 77 | Stability Control Light | 96 | Self-Sealing | 264 |
| Struts | | Control/Electronic Stability Control | 170 | Traction Devices | 274 |
| Gas | 252 | Off Light | 96 | Wheel Alignment and Tyre Balance | 274 |
| Stuck Vehicle | 155 | Traction Devices, | | Wheel Replacement | 274 |
| Summer Tyres | 265 | Tyres | 274 | When It Is Time for New Tyres | 272 |
| Sun Visors | 32 | Trademarks and Licence Agreements | 138 | Winter | 264 |
| Sunroof | 32 | Traffic | | U | |
| Surround | | Sign Assistant | 206 | Underhood | |
| Vision System | 185 | Trailer | | Compartment Fuse Block | 256 |
| Switches | | Sway Control (TSC) | 239 | Compartment Overview | 245 |
| Airbag On-Off | 55 | Towing | 228 | Updates | |
| Symbols | 2 | Transporting | | Software | 126 |
| System | | a Disabled Vehicle | 278 | USB Port | 130 |
| Airbag | 50 | | | | |

Using			
Infotainment System	124		
This Manual	1		
V			
Vehicle			
Ahead Indicator	96	Ventilation, Air	145
Alarm System	23	Visors	32
Automatic Hold	168	Voltage Devices and Wiring	254
Automatic Hold Light	95	W	
Control	151	Warning	
Data Recording and Privacy	303	Brake System Light	93
Identification Number (VIN)	294	Caution and Danger	1
Load Limits	155	Hazard Lights	117
Messages	110	Lights, Gauges, and Indicators	86
Ready Light	98	Triangle	77
Security	23	Washer Fluid	247
Service Soon Light	93	Wheels	
Speed Messages	112	Alignment and Tyre Balance	274
Starting and Stopping	160	Different Size	273
Status	106	Replacement	274
Symbols	2	When It Is Time for New Tyres	272
Vehicle Care		When to Charge	211
Tyre Pressure	265	Where to Put the Restraint	65
Vehicle Security		Windows	30
Steering Column Lock	25	Power	31
		Windscreen	
		Replacement	252
		Wiper/Washer	81
		Winter	
		Driving	154
		Tyres	264
		Wiper	
		Blade Replacement	252
		Wireless Charging	84
		Wiring, High Voltage Devices	254



Copyright Cadillac Europe GmbH, Zürich, Switzerland

All information contained in this booklet is based on latest product information available at the time of printing, and is effective as of the date indicated below, Cadillac Europe GmbH reserves the exclusive right to modifications to this booklet.

Edition: September 2023, Cadillac Europe GmbH, Zürich, Switzerland

Printed on chlorine-free bleached paper.



DLYAEBBE2408EN